

# Aqlus

COLLECTION

5.0

Guida operativa  
*Application guidance*

# Aqlus

In luce, con stile

---

Aqlus è il brand di Biffi Luce dedicato all'illuminazione di spazi architettonici e di arredo. Collaboriamo costantemente con designer affermati per ideare sistemi di illuminazione che, coniugando design contemporaneo e ricerca tecnica, enfatizzano e risaltano le caratteristiche progettuali ed emozionali della luce.

La bellezza della forma, la funzionalità del prodotto, la mutevolezza, fluidità e cangianza della vera protagonista degli spazi, la luce. Tutto questo è Aqlus.

*Aqlus is a brand of Biffi Luce dedicated to the enlightenment of architectural spaces. We constantly collaborate with prominent designers to realize innovative and technologically advanced lighting systems which emphasize and enhance the planning and emotional characteristics of light. Beautiful design, product functionality, mutability, fluidity and adjustability of the real protagonist of space, light. This is Aqlus.*

# INFORMAZIONI UTILI

## USEFUL INFORMATION

### SIMBOLI / SYMBOLS

	Fascio <i>Beam</i>
TC	Temperatura colore <i>Colour temperature</i>
IP	Grado di protezione (corpi solidi e liquidi) <i>Protection degree (solid and liquid objects)</i>
CRI	Resa cromatica <i>Colour rendering index</i>
EEl	Classe energetica <i>Energy class</i>
RG	Sicurezza fotobiologica <i>Photobiological safety</i>
03	Colore / finitura (vedi pag. 145) <i>Colour / finishing (see p. 145)</i>
08	
A	Accessori <i>Accessories</i>
D	Driver <i>Driver</i>
IK	Grado di protezione (impatti meccanici esterni) <i>Protection degree (external mechanical impacts)</i>

### COME COMPORRE IL CODICE PRODOTTO

Per comporre il codice è necessario osservare la tabella riportante i dati tecnici del prodotto.  
/DIMM 2-3 indica che è possibile richiedere la versione dimmerabile (informazioni tecniche a pag. 152/153).  
/EM indica che è possibile richiedere la versione emergenza (informazioni tecniche a pag. 154).

### HOW TO COMPOSE THE PRODUCT CODE

The product code can be composed observing the table reporting the technical specifications of the fixture.  
/DIMM 2-3 means it is possible to request a dimmable version of the lamp (technical specification p. 152/153).  
/EM means it is possible to request an emergency version of the lamp (technical specification p. 154).

### ESEMPIO / EXAMPLE cod. A8-660PL.140.30/DIMM2.46T008

CODICE	W	Lm (3000K)
A8-660PL.112...	35	4400
A8-660PL.140...	44	5500

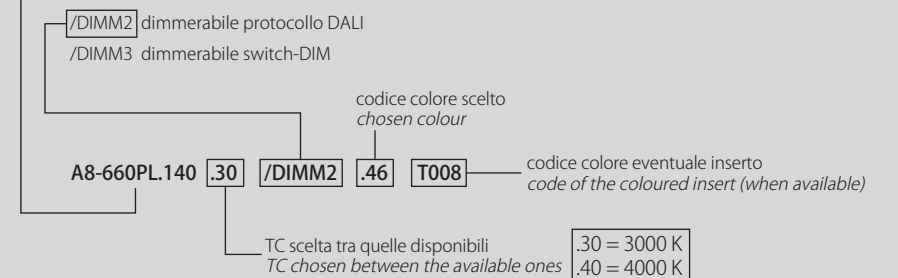

Il flusso nominale è riferito ai valori dichiarati dalla casa costruttrice ad una temperatura di giunzione di 65°C.  
Tutti i flussi nominali inseriti a catalogo si riferiscono ad una TC di 3000K.

The reported luminous flux is the one declared by the light manufacturer and it refers to the flux emitted by the LED light at a junction temperature of 65°C.  
All the luminous fluxes included in the catalogue refer to a colour temperature of 3000K.



La marcatura CE significa libertà di circolazione nel mercato europeo, è quindi il passaporto obbligatorio per le frontiere dell'Unione Europea.  
Tutti i nostri prodotti sono dichiarati e certificati rispondenti alle direttive specifiche quali: 2006/95 CE e 93/68 CEE relative alla sicurezza nonché alle direttive 2004/108/CE relativa alla compatibilità elettromagnetica.

The CE mark means that the products are allowed free circulation within the European market and it is therefore a compulsory requirement to allow products to cross the European frontiers. All our products carry approval declarations which conforms to the following specific directives: 2006/95 CE and 93/68 CEE concerning electrical safety as well as 2004/108/CE concerning electromagnetic compatibility.

PARETE/PLAFONE

WALL/CEILING 7

MISSY  
ALI  
MIA  
GAIA  
LYNN  
MAYA  
BEA  
EMMA  
EMMA UP  
LISA  
IRILED  
EK CUBO  
MUR  
FUSION  
SHARP  
WHEEL

SOSPENSIONI

HANGINGS 25

MISSY  
MERY  
FROY  
SHARP  
TIMBER  
FUSION

PROIETTORI/BINARI

SPOTLIGHTS/TRACKS 39

MIKE  
MIKE GRANDE  
TOV  
MUR  
ARCO  
ZETA  
HARRY  
DUE (BINARI / TRACKS)

INCASSI

RECESSED 63

BEN  
PALACE  
ROY  
JACK  
GIO'  
FLO  
BISS  
IRO  
IROTO  
EDO  
CHIC  
MIKE  
MIKE GRANDE  
EK  
COMFORT  
IDRO  
DEDILUS  
ZJ  
VELO  
AMBO

SISTEMI

SYSTEMS 93

TIMBER  
FUSION SOSPENSIONE  
FUSION PLAFONE  
FUSION INCASSO  
LINE SOSPENSIONE  
LINE PLAFONE  
LINE INCASSO  
MINILINE  
AT  
ESPO'  
ESPO'2  
FROY  
ASY  
LATY

ESTERNI

OUTDOOR 137

CABANA  
HAIKU  
OYS  
JAGO  
PLEUS

DATI TECNICI

TECHNICAL DATA 145

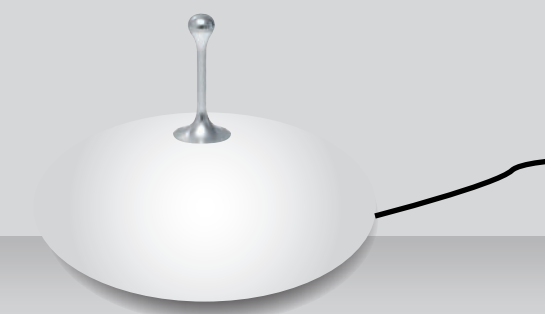

PARETE/PLAFONE  
WALL/CEILING

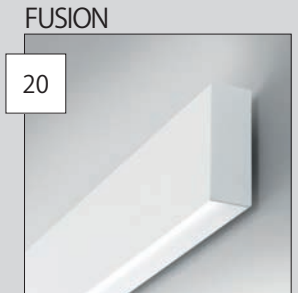
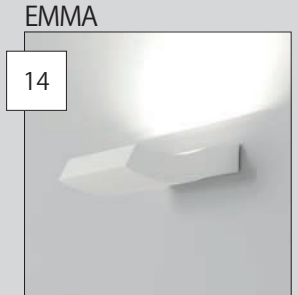
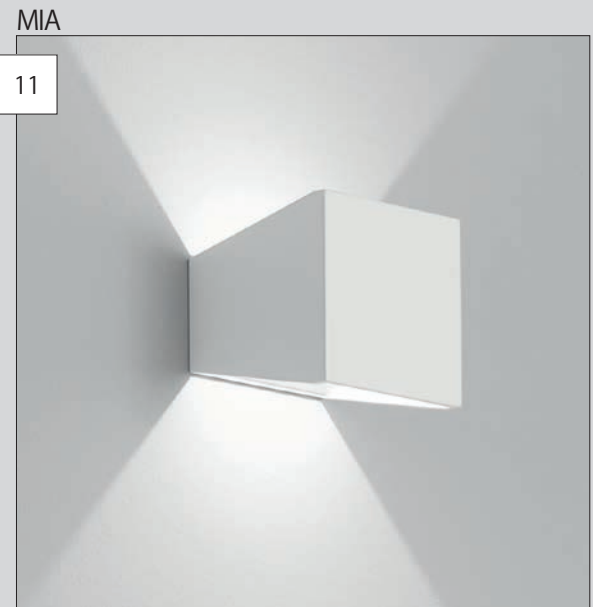
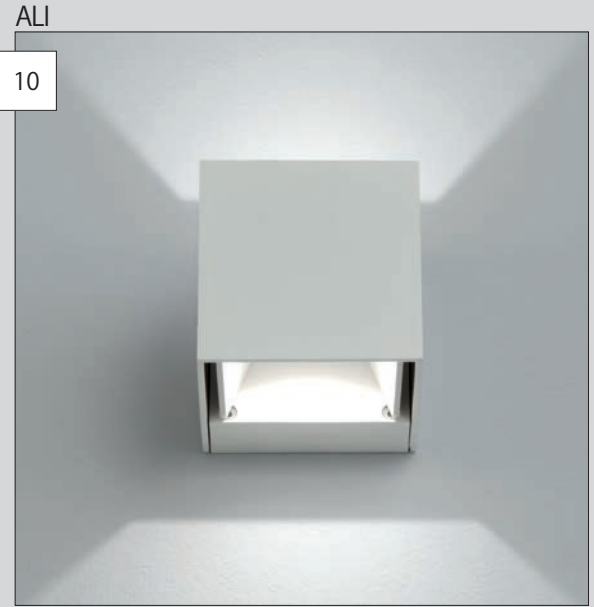



MISSY PICCOLO  
PLAFONE / CEILING

	(vedi tabella) (see table)
TC	3000K / 4000K
IP	40
CRI	>80
EEL	A+ (13W) A++ (12W - 17W)
RG	1
D	(vedi tabella) (see table)

- 03** Nero lucido
- 08** Bianco satinato

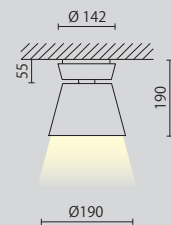

CODICE	W	Lm (3000K)	DRIVER		€ (IVA esclusa) / (VAT excluded)
A4-640.13...	13	1100	non richiesto / not requested	110°	235,00
A4-641.15...	12	1880	incluso / included	50° (a richiesta 16°)* / (16° on request)*	250,00
A4-641.20...	17	2620	incluso / included	50° (a richiesta 16°)* / (16° on request)*	260,00

\*cod. PA 011-16



MISSY GRANDE  
PLAFONE / CEILING

	(vedi tabella) (see table)
TC	3000K / 4000K
IP	40
CRI	>80
EEL	A+ (25W) A++ (33W)
RG	1
D	(vedi tabella) (see table)

- 03** Nero lucido
- 08** Bianco satinato

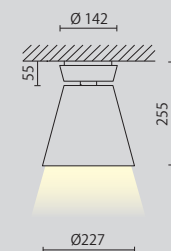

CODICE	W	Lm (3000K)	DRIVER		€ (IVA esclusa) / (VAT excluded)
A4-645.25...	25	2000	non richiesto / not requested	110°	260,00
A4-646.35...	33	4400	incluso / included	50° (a richiesta 20°)* / (20° on request)*	270,00

\*cod. PA 010-20





## ALI

PARETE / WALL

- Max 90°
- TC 3000K (a richiesta 4000K) (4000K on request)
- IP 54
- CRI >80
- EEI A+
- RG 1
- D Driver incluso (Driver included)

- 08 Bianco satinato
- 38 Grigio antracite

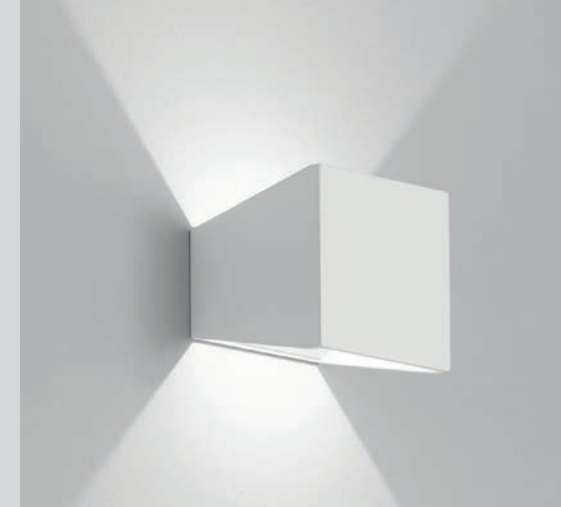
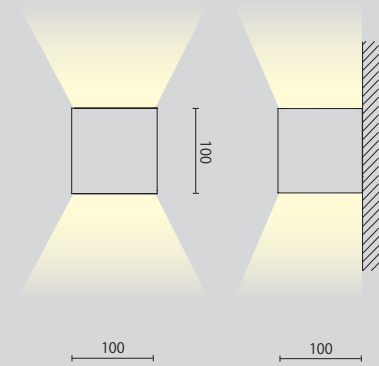

## MIA

PARETE / WALL

- 70°
- TC 3000K
- IP 20
- CRI >80
- EEI A+
- RG 0
- D Driver incluso (Driver included)

- 08 Bianco satinato

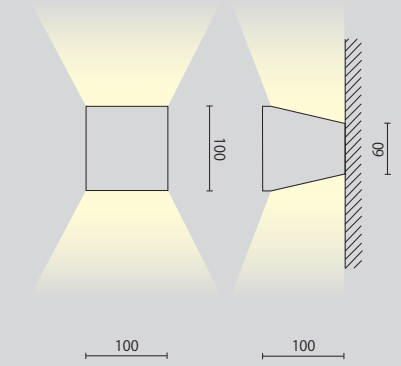

CODICE	W	Lm (3000K)	€ (IVA esclusa) / (VAT excluded)
A9-660.30	10	2x420	149,00

CODICE	W	Lm	€ (IVA esclusa) / (VAT excluded)
A9-651.30	11	885	89,00



## GAIA

PARETE / WALL

- 100°
- TC 3000K
- IP 20
- CRI >80
- EEI A+
- RG 0
- D Driver incluso (Driver included)

- 08 Bianco satinato

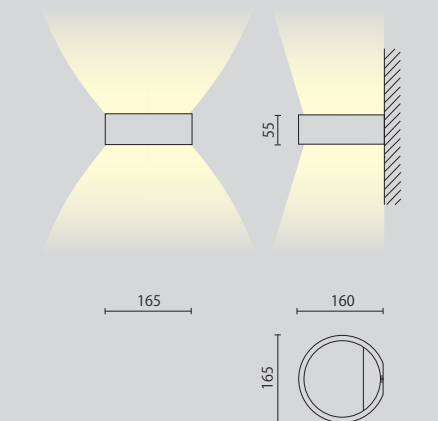

CODICE	W	Lm	€ (IVA esclusa) / (VAT excluded)
A9-650.30	11	885	115,00



## LYNN

PARETE / WALL

- 90°
- TC 3000K
- IP 44
- CRI >80
- EEI A+
- RG 0
- D Driver incluso  
Driver included

08 Bianco satinato

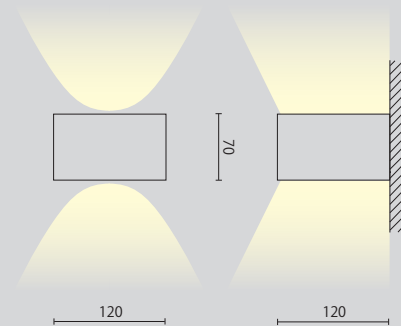

CODICE	W	Lm	€ (IVA esclusa) / (VAT excluded)
A9-652.30	9	360	139,00



## BEA

PARETE/PLAFONE / WALL/CEILING

- 40° (a richiesta 20°)\*  
(20° on request)\*
- TC 3000K
- IP 40
- CRI 93
- EEI A+
- RG 1
- D Driver incluso  
Driver included

08 Bianco satinato

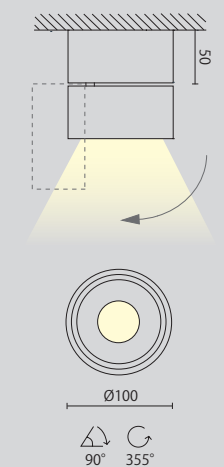

CODICE	W	Lm	€ (IVA esclusa) / (VAT excluded)
A4-650.15.30	15	1320	169,00

\*cod. PA 025-20



## MAYA

PARETE / WALL

- 90°
- TC 3000K
- IP 40
- CRI >80
- EEI A+
- RG 0
- D Driver incluso  
Driver included

08 Bianco satinato

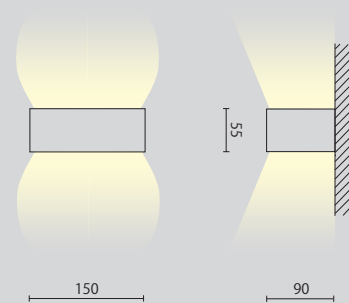

CODICE	W	Lm	€ (IVA esclusa) / (VAT excluded)
A9-654.30	11	850	120,00





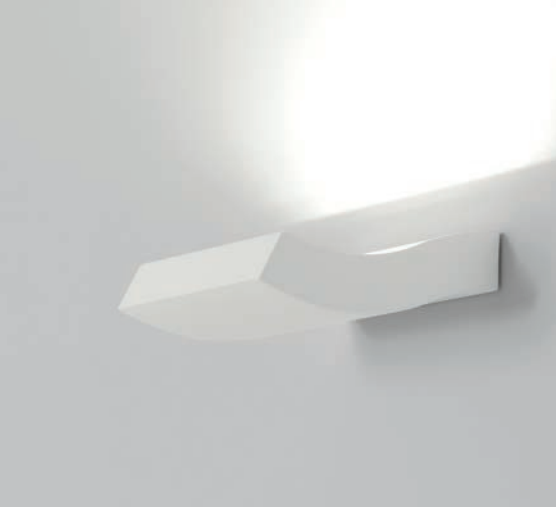







## EMMA

PARETE / WALL

-  110°
-  TC 3000K / 4000K
-  IP 40
-  CRI >80
-  EEI A++
-  RG 0
-  D Driver incluso  
Driver included

08 Bianco satinato

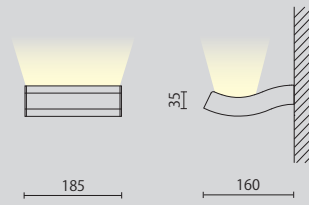







CODICE	W	Lm (3000K)	€ (IVA esclusa) / (VAT excluded)
A9-620...	13	1640	195,00



## LISA

PARETE / WALL

-  100°
-  TC 3000K / 4000K
-  IP 40
-  CRI >80
-  EEI A+
-  RG 0
-  D Driver non richiesto  
Driver not requested

08 Bianco satinato

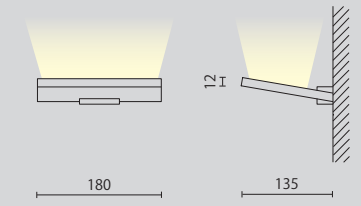



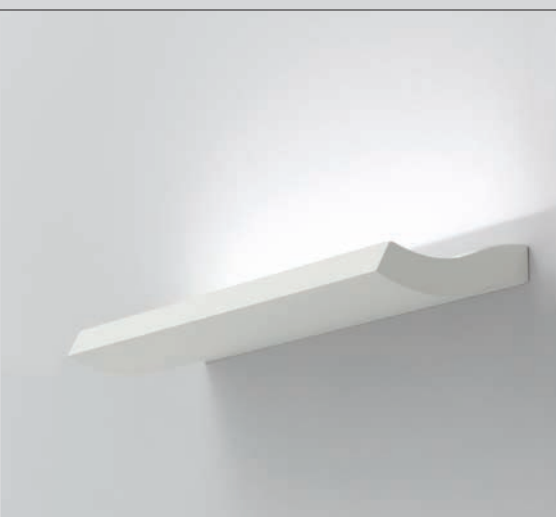



CODICE	W	Lm (3000K)	€ (IVA esclusa) / (VAT excluded)
A9-626...	18	1560	280,00



## EMMA UP

PARETE / WALL

-  110°
-  TC 3000K / 4000K
-  IP 40
-  CRI >80
-  EEI A++
-  RG 0
-  D Driver incluso  
Driver included

08 Bianco satinato

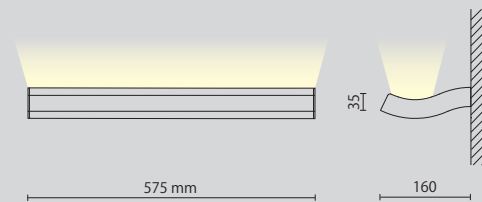

CODICE	W	Lm (3000K)	€ (IVA esclusa) / (VAT excluded)
A9-621...	23	3000	290,00





## IRILED

PARETE / WALL

- 37°/73°
- TC 3000K
- IP 40
- CRI >80
- EEI A+
- RG 1
- D Driver incluso  
Driver included

- 05 Nero anodizzato
- 20 Anodizzato naturale

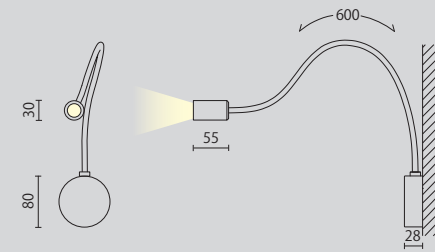

CODICE	W	Lm	€ (IVA esclusa) / (VAT excluded)
A9-628.30	3	230	160,00



## EK CUBO

PARETE / WALL

- 100°
- TC 3000K / 4000K
- IP 20
- CRI >80
- EEI A+
- RG 0
- D Driver non richiesto  
Driver not requested

- 08/02 Bianco satinato/Nero opaco
- 08 Bianco satinato

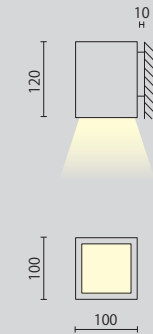

CODICE	W	Lm (3000K)	€ (IVA esclusa) / (VAT excluded)
A9-613...	15	1350	180,00



## EK CUBO

PLAFONE / CEILING

- 100°
- TC 3000K / 4000K
- IP 43
- CRI >80
- EEI A+
- RG 0
- D Driver non richiesto  
Driver not requested

- 08/02 Bianco satinato/Nero opaco
- 08 Bianco satinato

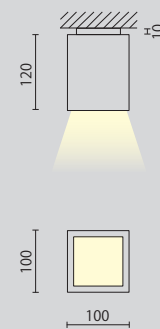

CODICE	W	Lm (3000K)	€ (IVA esclusa) / (VAT excluded)
A4-613...	15	1350	180,00

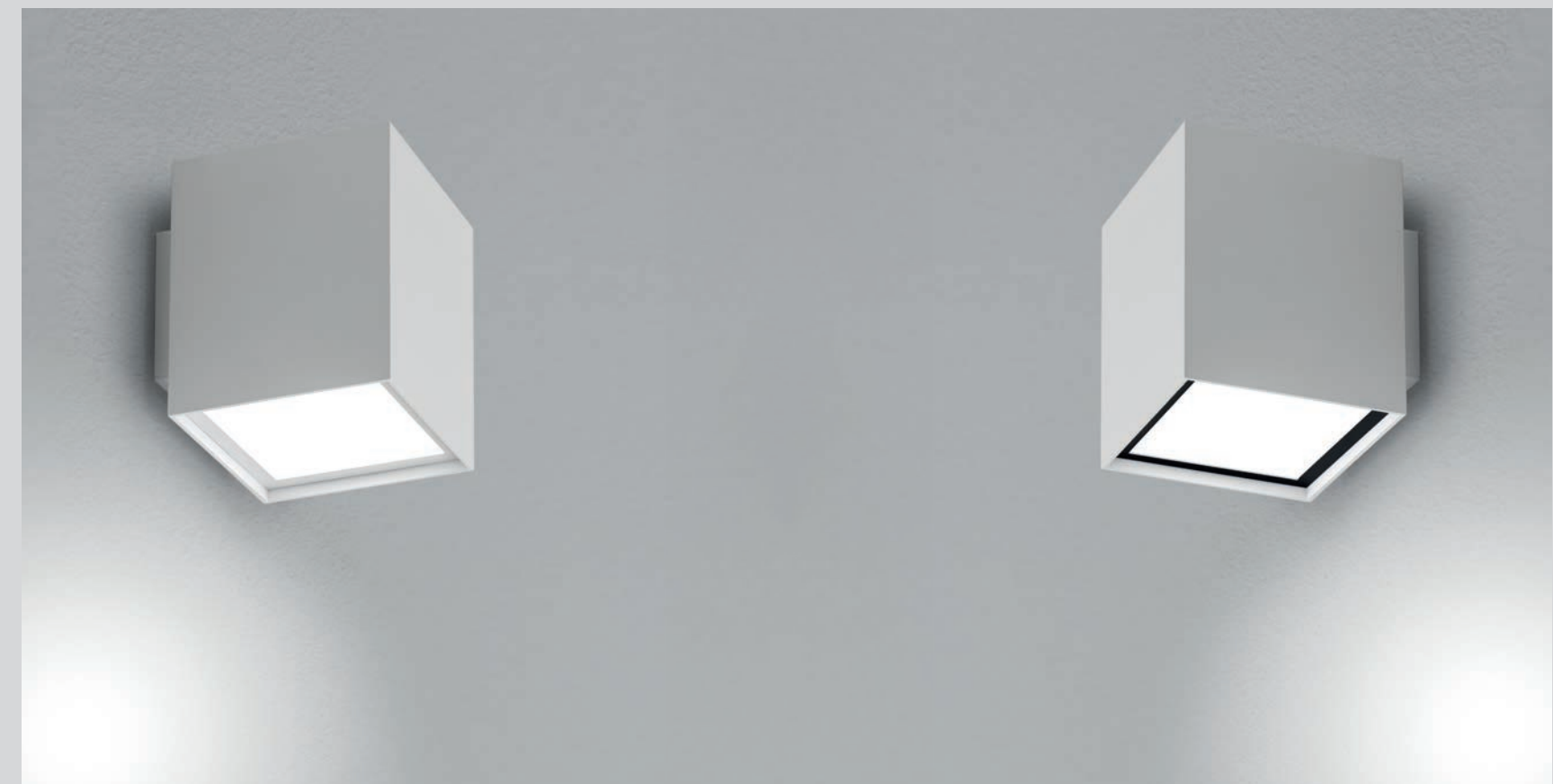

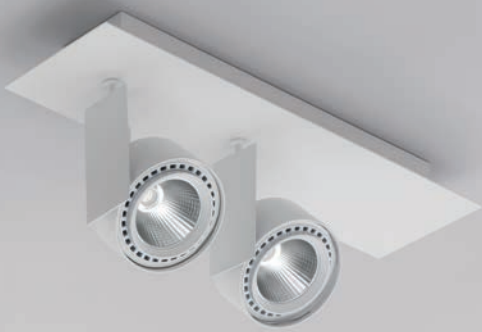

**MUR Ø120 2X**  
PARETE/PLAFONE / WALL / CEILING

- 40° (a richiesta 24°)\*  
(24° on request)\*
- 3000K / 4000K
- 40
- 93 (a richiesta >80)  
(>80 on request)
- A++
- 1
- Driver incluso  
Driver included

- Bianco satinato/Nero opaco
- Nero opaco
- Bianco satinato

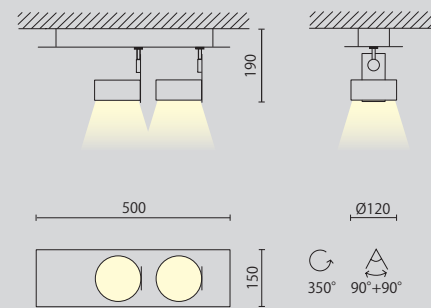

**MUR Ø120 4X**  
PARETE/PLAFONE / WALL / CEILING

- 40° (a richiesta 24°)\*  
(24° on request)\*
- 3000K / 4000K
- 40
- 93 (a richiesta >80)  
(>80 on request)
- A++
- 1
- Driver incluso  
Driver included

- Bianco satinato/Nero opaco
- Nero opaco
- Bianco satinato

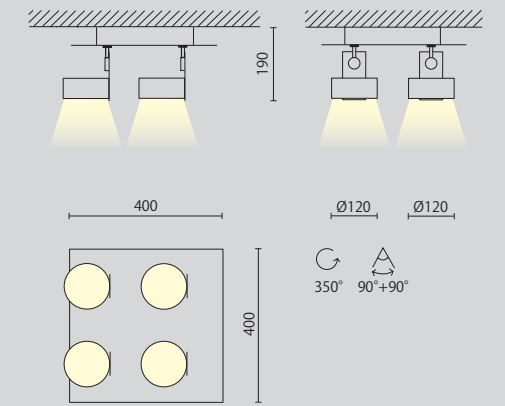

CODICE	W	Lm (3000K)	€ (IVA esclusa) / (VAT excluded)
A4-600.212...	2x12	2x1615	330,00
A4-600.217...	2x17	2x2240	340,00
A4-600.223...	2x23	2x3025	360,00

\*cod. PA 014-24

CODICE	W	Lm (3000K)	€ (IVA esclusa) / (VAT excluded)
A4-602.412...	4x12	4x1615	495,00
A4-602.417...	4x17	4x2240	520,00
A4-602.423...	4x23	4x3025	550,00

\*cod. PA 014-24



**MUR Ø60 2X**  
PARETE/PLAFONE / WALL / CEILING

- 30°
- 3000K / 4000K
- 40
- 93 (a richiesta >80)  
(>80 on request)
- A++
- 1
- Driver incluso  
Driver included

- Bianco satinato/Nero opaco
- Nero opaco
- Bianco satinato

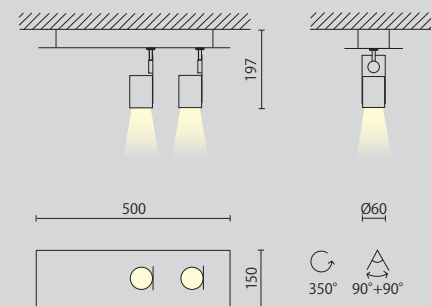

**MUR Ø60 4X**  
PARETE/PLAFONE / WALL / CEILING

- 30°
- 3000K / 4000K
- 40
- 93 (a richiesta >80)  
(>80 on request)
- A++
- 1
- Driver incluso  
Driver included



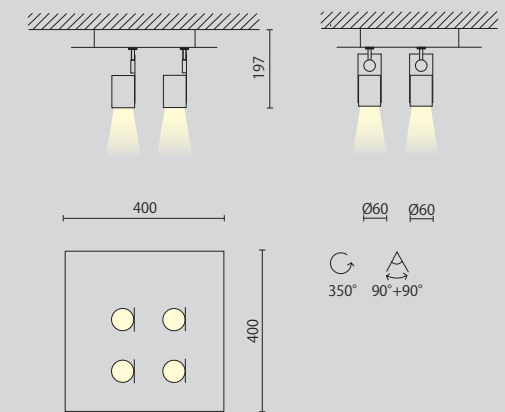



- Bianco satinato/Nero opaco
- Nero opaco
- Bianco satinato



CODICE	W	Lm (3000K)	€ (IVA esclusa) / (VAT excluded)
A4-202.2...	2x9	2x1115	345,00

CODICE	W	Lm (3000K)	€ (IVA esclusa) / (VAT excluded)
A4-203.4...	4x9	4x1115	550,00

FUSION PRO BIDIFFUSIONE  
PARETE / WALL

-  ↓70°/↑120°
-  3000K / 4000K
-  40
-  >80
-  A++
-  0
-  Driver incluso  
Driver included

08 Bianco satinato

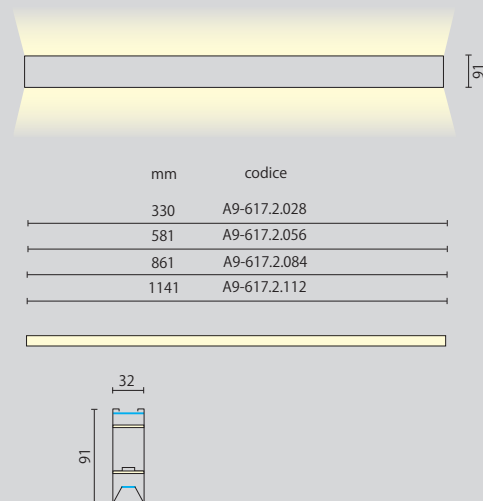







mm	codice
330	A9-617.2.028
581	A9-617.2.056
861	A9-617.2.084
1141	A9-617.2.112

CODICE	W	Lm (3000K)	€ (IVA esclusa) / (VAT excluded)	... /DIMM2-3 (Dimmerabile)
A9-617.2.028...	2x10	2x1320	245,00	-
A9-617.2.056...	2x20	2x2640	295,00	348,00
A9-617.2.084...*	2x30	2x3960	425,00	490,00
A9-617.2.112...*	2x40	2x5280	470,00	560,00
LE001-30/100**	lente fascio 30° / 30° lens		15,00	

\*doppia accensione, \*\*codice e prezzo al metro / \*double switch, \*\*code and price per meter

FUSION PRO LIGHT BIDIFFUSIONE  
PARETE / WALL

-  ↓70°/↑120°
-  3000K / 4000K
-  40
-  >80
-  A++
-  0
-  Driver incluso  
Driver included

08 Bianco satinato

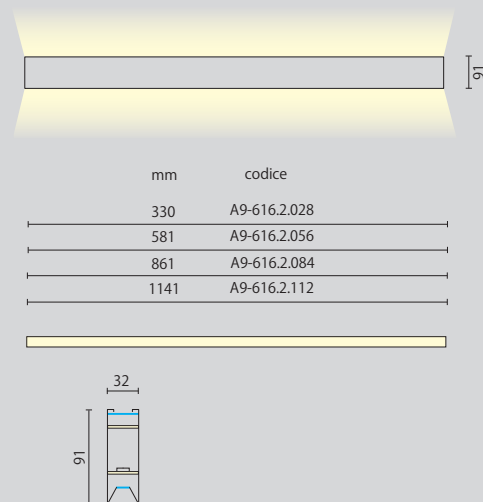

mm	codice
330	A9-616.2.028
581	A9-616.2.056
861	A9-616.2.084
1141	A9-616.2.112

CODICE	W	Lm (3000K)	€ (IVA esclusa) / (VAT excluded)	... /DIMM2-3 (Dimmerabile)
A9-616.2.028...	2x9	2x1100	210,00	-
A9-616.2.056...	2x18	2x2200	265,00	330,00
A9-616.2.084...*	2x27	2x3300	330,00	395,00
A9-616.2.112...*	2x35	2x4400	380,00	450,00
LE001-30/100**	lente fascio 30° / 30° lens		15,00	





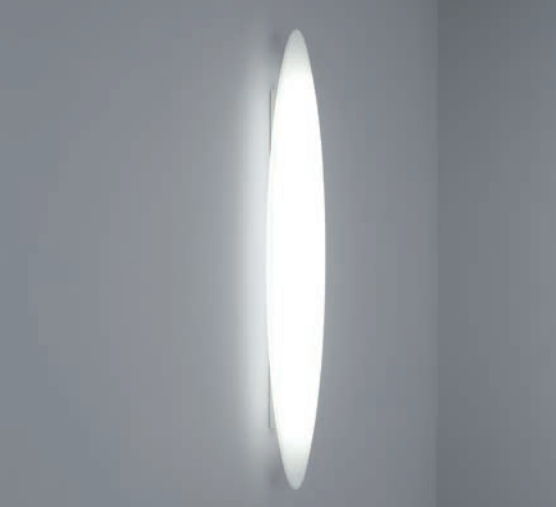

\*doppia accensione, \*\*codice e prezzo al metro / \*double switch, \*\*code and price per meter





## SHARP

PARETE/PLAFONE / WALL/CEILING

-  360°
-  TC 3000K / 4000K
-  IP 40
-  CRI >80
-  EEI A++
-  RG 0
-  D Driver incluso  
Driver included

08 Bianco satinato

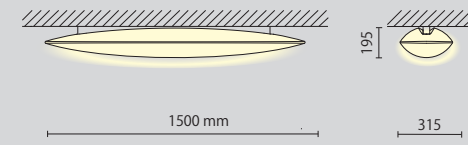



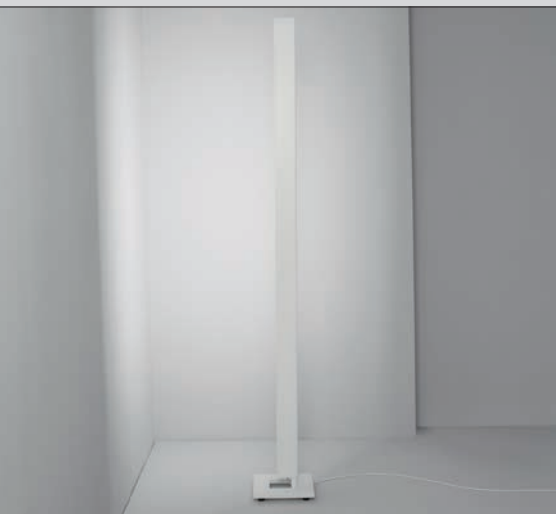



CODICE	W	Lm (3000K)	€ (IVA esclusa) / (VAT excluded)	... /DIMM2-3 (Dimmerabile)
A4-630.036...	36	4400	450,00	490,00
A4-631.048...	48	6000	520,00	580,00



## WHEEL

TERRA / FLOOR

-  140°
-  TC 3000K / 4000K
-  IP 40
-  CRI >80
-  EEI A++
-  RG 0
-  D Driver incluso  
Driver included

08 Bianco satinato  
29 Bronzo metallizzato

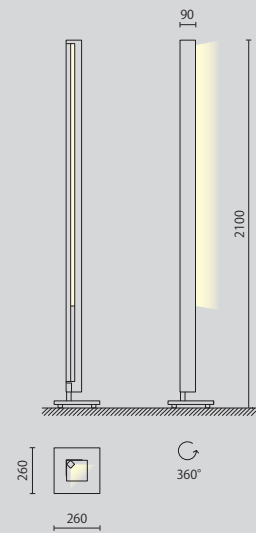

CODICE	W	Lm (3000K)	€ (IVA esclusa) / (VAT excluded)
A3-400...	27	3650	730,00



SOSPENSIONI

HANGINGS

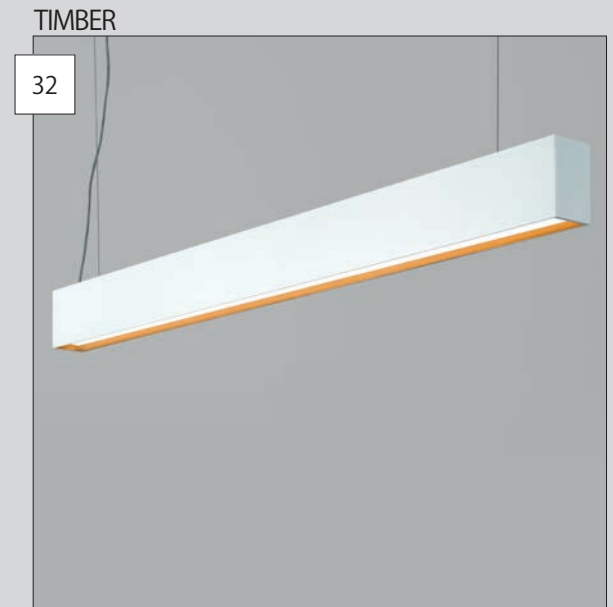
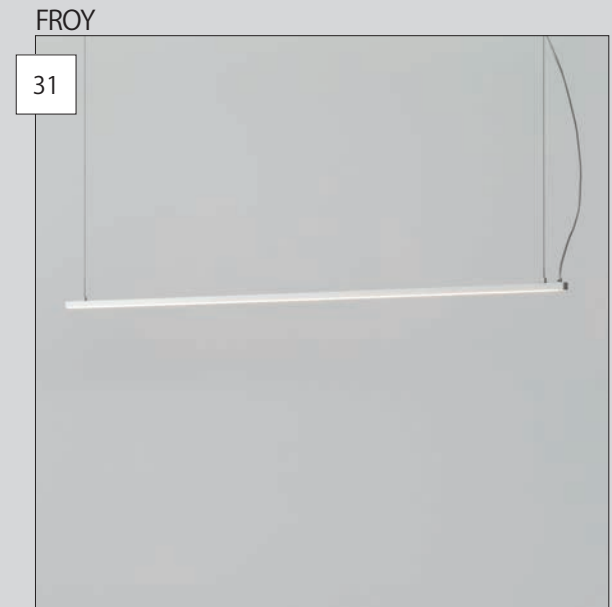
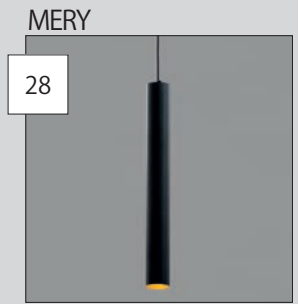



MISSY PICCOLO  
SOSPENSIONE / HANGING

- (vedi tabella) / (see table)
- 3000K / 4000K
- 40
- >80
- A+ (13W)  
A++ (12W-17W)
- 1
- (vedi tabella) / (see table)

- 03 Nero lucido
- 08 Bianco satinato

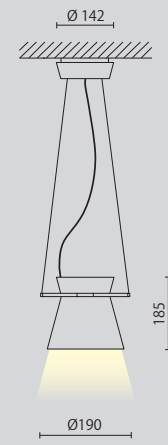

CODICE	W	Lm (3000K)	DRIVER		€ (IVA esclusa) / (VAT excluded)
A8-640.13...	13	1100	non richiesto / not requested	110°	279,00
A8-641.15...	12	1880	incluso / included	50° (a richiesta 16°)* / (16° on request)*	290,00
A8-641.20...	17	2620	incluso / included	50° (a richiesta 16°)* / (16° on request)*	300,00

\*cod. PA 011-16



MISSY GRANDE  
SOSPENSIONE / HANGING

- (vedi tabella) / (see table)
- 3000K / 4000K
- 40
- >80
- A+ (25W)  
A++ (33W)
- 1
- (vedi tabella) / (see table)

- 03 Nero lucido
- 08 Bianco satinato

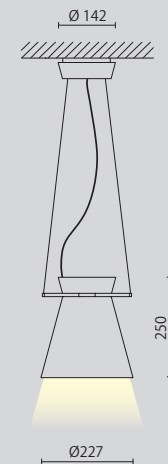

CODICE	W	Lm (3000K)	DRIVER		€ (IVA esclusa) / (VAT excluded)
A8-645.25...	25	2000	non richiesto / not requested	110°	295,00
A8-646.35...	33	4400	incluso / included	50° (a richiesta 20°)* / (20° on request)*	315,00

\*cod. PA 010-20



MISSY GRANDE BIDIFFUSIONE  
SOSPENSIONE / HANGING

- 110°
- 3000K / 4000K
- 40
- >80
- A+
- 1
- Driver non richiesto / Driver not requested

- 03 Nero lucido
- 08 Bianco satinato

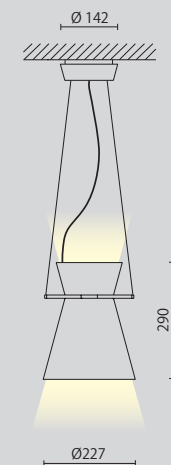

CODICE	W	Lm (3000K)	€ (IVA esclusa) / (VAT excluded)
A8-648.2...	13+25	1100+2000	395,00



Abitazione privata, Varese



MERY 50  
SOSPENSIONE / HANGING

- 40°
- 3000K / 4000K
- IP 40
- CRI >80
- EEI A++
- RG 1
- D Driver incluso / Driver included

COLORE PROFILO / BODY COLOUR

- 02 Nero opaco
- 08 Bianco satinato

COLORE ANELLO / RING COLOUR

- 02 Nero opaco
- A AN001.08 Anello bianco (escluso) / White ring (not included)
- AN001.13 Anello oro (escluso) / Gold ring (not included)

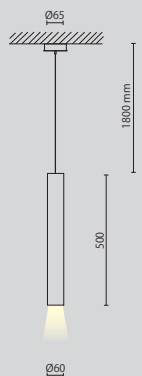

CODICE	W	Lm (3000K)	€ (IVA esclusa) / (VAT excluded)
A8-650.050...	7	1040	185,00



MERY 100  
SOSPENSIONE / HANGING

- 40°
- 3000K / 4000K
- IP 40
- CRI >80
- EEI A++
- RG 1
- D Driver incluso / Driver included

COLORE PROFILO / BODY COLOUR

- 02 Nero opaco
- 08 Bianco satinato

COLORE ANELLO / RING COLOUR

- 02 Nero opaco
- A AN001.08 Anello bianco (escluso) / White ring (not included)
- AN001.13 Anello oro (escluso) / Gold ring (not included)

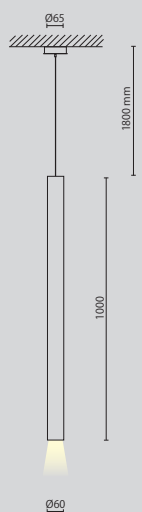

CODICE	W	Lm (3000K)	€ (IVA esclusa) / (VAT excluded)
A8-650.100...	7	1040	205,00







## FROY

SOSPENSIONE / HANGING

- 105°
- TC 3000K / 4000K
- IP 40
- CRI >80
- EEI A+
- RG 0
- D Driver incluso  
Driver included

- 02 Nero opaco
- 09 Bianco opaco

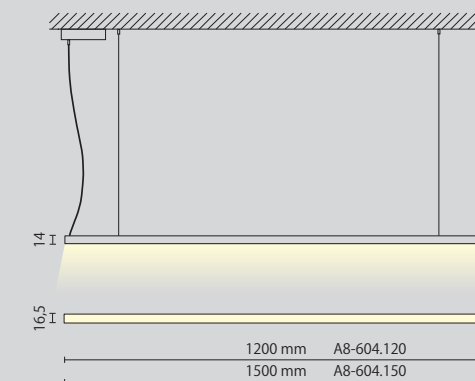

CODICE	W	Lm (3000K)	€ (IVA esclusa) / (VAT excluded)
A8-604.120...	30	3000	220,00
A8-604.150...	38	3750	240,00



## SHARP

SOSPENSIONE / HANGING





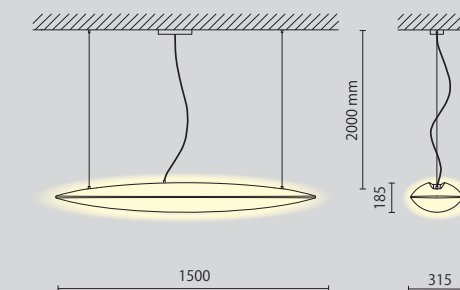

- 360°
- TC 3000K / 4000K
- IP 40
- CRI >80
- EEI A++
- RG 0
- D Driver incluso  
Driver included

- 08 Bianco satinato





CODICE	W	Lm (3000K)	€ (IVA esclusa) / (VAT excluded)	.../DIMM2-3 (Dimmerabile)
A8-630.036...	36	4400	470,00	510,00
A8-631.048...	48	6000	535,00	595,00



**TIMBER** PRO LIGHT MONOEMISSIONE  
SOSPENSIONE / HANGING

-  75°
-  3000K / 4000K
-  40
-  >80
-  A++
-  0
-  Driver incluso  
Driver included

COLORE PROFILO / BODY COLOUR

-  02 Nero opaco
-  08 Bianco satinato
-  46 Rovere sbiancato

COLORE INSERTO / COLOURED INSERT



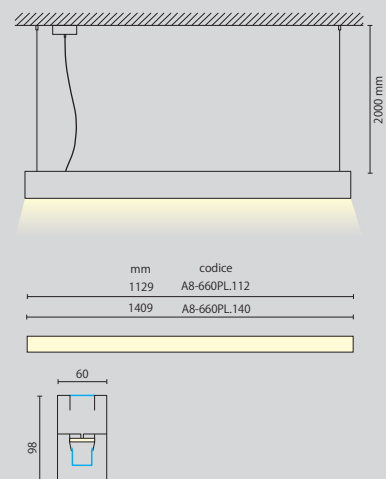



-  T002 Nero opaco
-  T008 Bianco satinato
-  T013 Oro





CODICE	W	Lm (3000K)	€ (IVA esclusa) / (VAT excluded) Colore 02-08 / Colour 02-08	€/DIMM2-3 (Dimmerabile) Colore 02-08 / Colour 02-08	€ (IVA esclusa) / (VAT excluded) Colore 46 / Colour 46	€/DIMM2-3 (Dimmerabile) Colore 46 / Colour 46	€ (IVA esclusa) / (VAT excluded) Inserti (coppia) / Inserts (pair)
A8-660PL.112...	35	4400	390,00	423,00	445,00	480,00	40,00
A8-660PL.140...	44	5500	450,00	480,00	510,00	540,00	48,00

.../EM (a richiesta) / (on request)



**TIMBER** PRO LIGHT BIEMISSIONE  
SOSPENSIONE / HANGING

-  ↓75°/↑100°
-  3000K / 4000K
-  40
-  >80
-  A++
-  0
-  Driver incluso  
Driver included

COLORE PROFILO / BODY COLOUR

-  02 Nero opaco
-  08 Bianco satinato
-  46 Rovere sbiancato

COLORE INSERTO / COLOURED INSERT

-  T002 Nero opaco
-  T008 Bianco satinato
-  T013 Oro

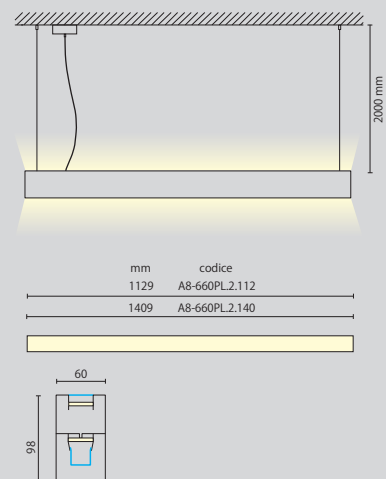

CODICE	W	Lm (3000K)	€ (IVA esclusa) / (VAT excluded) Colore 02-08 / Colour 02-08	€/DIMM2-3 (Dimmerabile) Colore 02-08 / Colour 02-08	€ (IVA esclusa) / (VAT excluded) Colore 46 / Colour 46	€/DIMM2-3 (Dimmerabile) Colore 46 / Colour 46	€ (IVA esclusa) / (VAT excluded) Inserti (coppia) / Inserts (pair)
A8-660PL.2.112...	2x35	2x4400	490,00	550,00	540,00	600,00	40,00
A8-660PL.2.140...	2x44	2x5500	570,00	630,00	635,00	695,00	48,00







doppia accensione / double switch

.../EM (a richiesta) / (on request)





## TIMBER SOFT MONOEMISSIONE

SOSPENSIONE / HANGING

-  75°
-  3000K / 4000K
-  40
-  >80
-  A++
-  0
-  Driver incluso  
Driver included

COLORE PROFILO / BODY COLOUR

-  02 Nero opaco
-  08 Bianco satinato
-  46 Rovere sbiancato

COLORE INSERTO / COLOURED INSERT

-  T002 Nero opaco
-  T008 Bianco satinato
-  T013 Oro

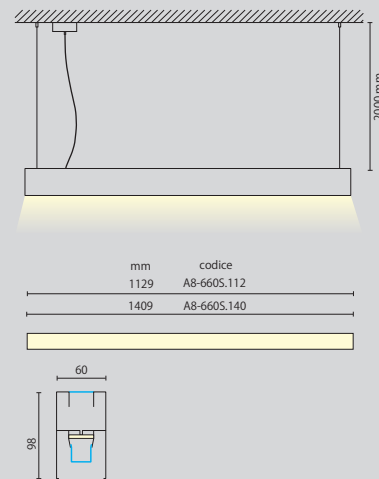

CODICE	W	Lm (3000K)	€ (IVA esclusa) / (VAT excluded) Colore 02-08 / Colour 02-08	../DIMM2-3 (Dimmerabile) Colore 02-08 / Colour 02-08	€ (IVA esclusa) / (VAT excluded) Colore 46 / Colour 46	../DIMM2-3 (Dimmerabile) Colore 46 / Colour 46	€ (IVA esclusa) / (VAT excluded) Inserti (coppia) / Inserts (pair)
A8-660S.112...	24	3250	370,00	402,00	425,00	456,00	40,00
A8-660S.140...	30	4060	426,00	455,00	484,00	510,00	48,00







../EM (a richiesta) / (on request)





Decox, elettrodomestici

## TIMBER SOFT BIEMISSIONE

SOSPENSIONE / HANGING

-  ↓75° / ↑100°
-  3000K / 4000K
-  40
-  >80
-  A++
-  0
-  Driver incluso  
Driver included

COLORE PROFILO / BODY COLOUR

-  02 Nero opaco
-  08 Bianco satinato
-  46 Rovere sbiancato

COLORE INSERTO / COLOURED INSERT

-  T002 Nero opaco
-  T008 Bianco satinato
-  T013 Oro

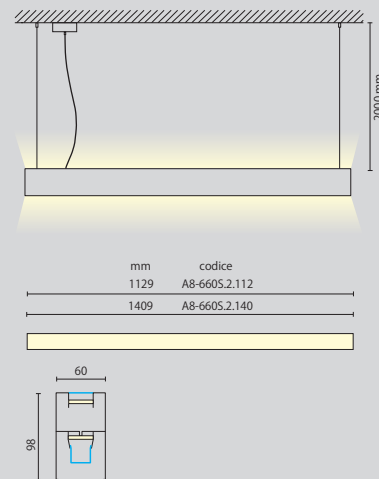

CODICE	W	Lm (3000K)	€ (IVA esclusa) / (VAT excluded) Colore 02-08 / Colour 02-08	../DIMM2-3 (Dimmerabile) Colore 02-08 / Colour 02-08	€ (IVA esclusa) / (VAT excluded) Colore 46 / Colour 46	../DIMM2-3 (Dimmerabile) Colore 46 / Colour 46	€ (IVA esclusa) / (VAT excluded) Inserti (coppia) / Inserts (pair)
A8-660S.2.112...	2x24	2x3250	465,00	522,00	513,00	570,00	40,00
A8-660S.2.140...	2x30	2x4060	540,00	598,00	600,00	660,00	48,00

../EM (a richiesta) / (on request)

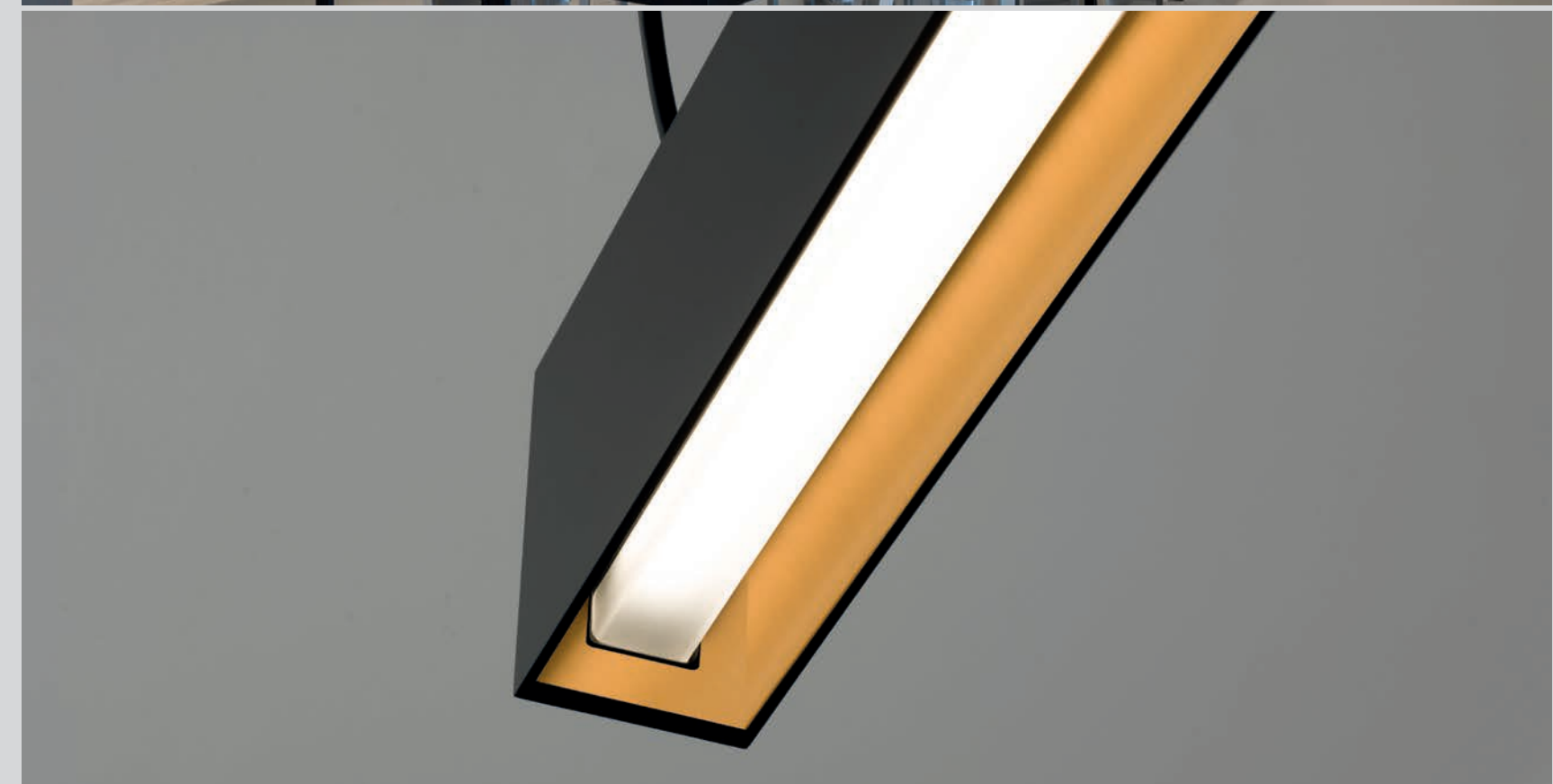

doppia accensione / double switch



Diffusore opalino  
Frosted light diffuser



Lente fascio 30°  
30° lens



## FUSION PRO BIDIFFUSIONE

SOSPENSIONE / HANGING

- ↓ 70° / ↑ 120°
- 3000K / 4000K
- 40
- >80
- A++
- 0
- Driver incluso  
Driver included

**08** Bianco satinato

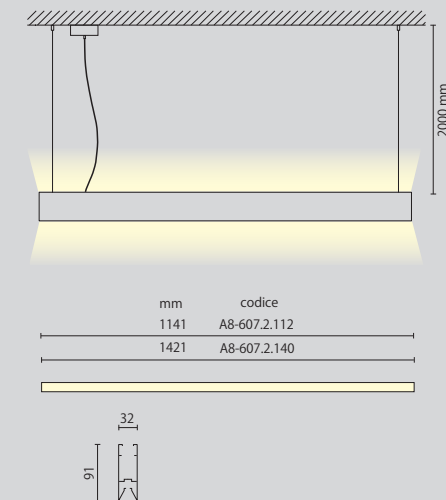

CODICE	W	Lm (3000K)	€ (IVA esclusa) / (VAT excluded)	... / DIMM2-3 (Dimmerabile)
A8-607.2.112...	2x40	2x5280	510,00	580,00
A8-607.2.140...	2x50	2x6600	590,00	670,00
LE001-30/100*	lente fascio 30° / 30° lens		15,00	

doppia accensione, \*codice e prezzo al metro / double switch, \*code and price per meter



## FUSION PRO LIGHT BIDIFFUSIONE

SOSPENSIONE / HANGING

- ↓ 70° / ↑ 120°
- 3000K / 4000K
- 40
- >80
- A++
- 0
- Driver incluso  
Driver included

**08** Bianco satinato

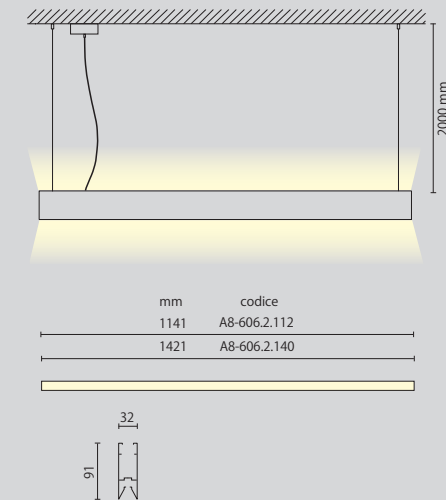

CODICE	W	Lm (3000K)	€ (IVA esclusa) / (VAT excluded)	... / DIMM2-3 (Dimmerabile)
A8-606.2.112...	2x35	2x4400	425,00	506,00
A8-606.2.140...	2x44	2x5500	496,00	579,00
LE001-30/100*	lente fascio 30° / 30° lens		15,00	

doppia accensione, \*codice e prezzo al metro / double switch, \*code and price per meter

PROIETTORI / BINARI  
SPOTLIGHTS / TRACKS

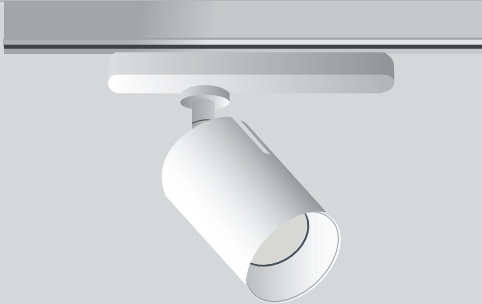

MIKE

40



MIKE GRANDE

42



TOV

44



MUR

46

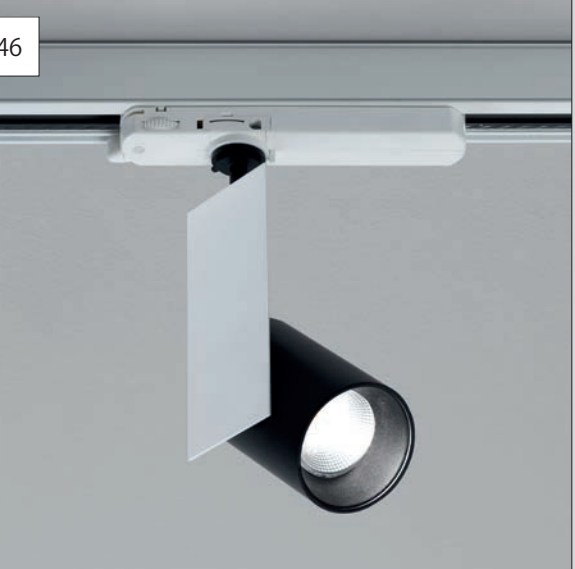

ARCO

52



ZETA

56



HARRY

58



DUE (BINARI / TRACKS)

60





MIKE DA BINARIO  
PROIETTORE / SPOTLIGHT

- 40° (a richiesta 20°)\*  
(20° on request)\*
- 3000K / 4000K
- 40
- 93 (a richiesta >80)  
(>80 on request)
- A++
- 1
- Driver incluso  
Driver included

COLORE PROFILO / BODY COLOUR

02 Nero opaco

08 Bianco satinato

COLORE ANELLO / RING COLOUR

02 Nero opaco

A AN001.08 Anello bianco (escluso) / White ring (not included)  
AN001.13 Anello oro (escluso) / Gold ring (not included)

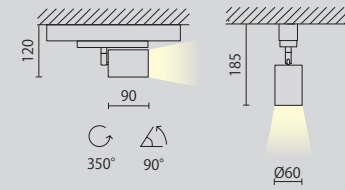

CODICE	W	Lm (3000K)	€ (IVA esclusa) / (VAT excluded)
A2-609.12.../D	12	1470	169,00

\*cod. PA 022-20



MIKE 230V  
PROIETTORE / SPOTLIGHT

- 40° (a richiesta 20°)\*  
(20° on request)\*
- 3000K / 4000K
- 40
- >80
- A+
- 1
- Driver non richiesto  
Driver not requested

COLORE PROFILO / BODY COLOUR

02 Nero opaco

08 Bianco satinato

COLORE ANELLO / RING COLOUR

02 Nero opaco

A AN001.08 Anello bianco (escluso) / White ring (not included)  
AN001.13 Anello oro (escluso) / Gold ring (not included)

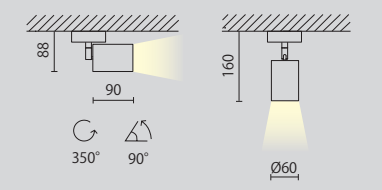

CODICE	W	Lm (3000K)	€ (IVA esclusa) / (VAT excluded)
A2-610.08AC...	8	704	118,00

\*cod. PA 022-20



MIKE 230V DA BINARIO  
PROIETTORE / SPOTLIGHT

- 40° (a richiesta 20°)\*  
(20° on request)\*
- 3000K / 4000K
- 40
- >80
- A+
- 1
- Driver non richiesto  
Driver not requested

COLORE PROFILO / BODY COLOUR

02 Nero opaco

08 Bianco satinato

COLORE ANELLO / RING COLOUR

02 Nero opaco

A AN001.08 Anello bianco (escluso) / White ring (not included)  
AN001.13 Anello oro (escluso) / Gold ring (not included)

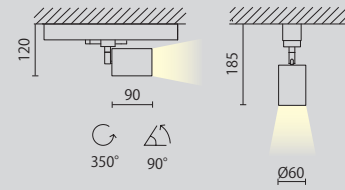

CODICE	W	Lm (3000K)	€ (IVA esclusa) / (VAT excluded)
A2-610.08AC.../D	8	704	118,00

\*cod. PA 022-20

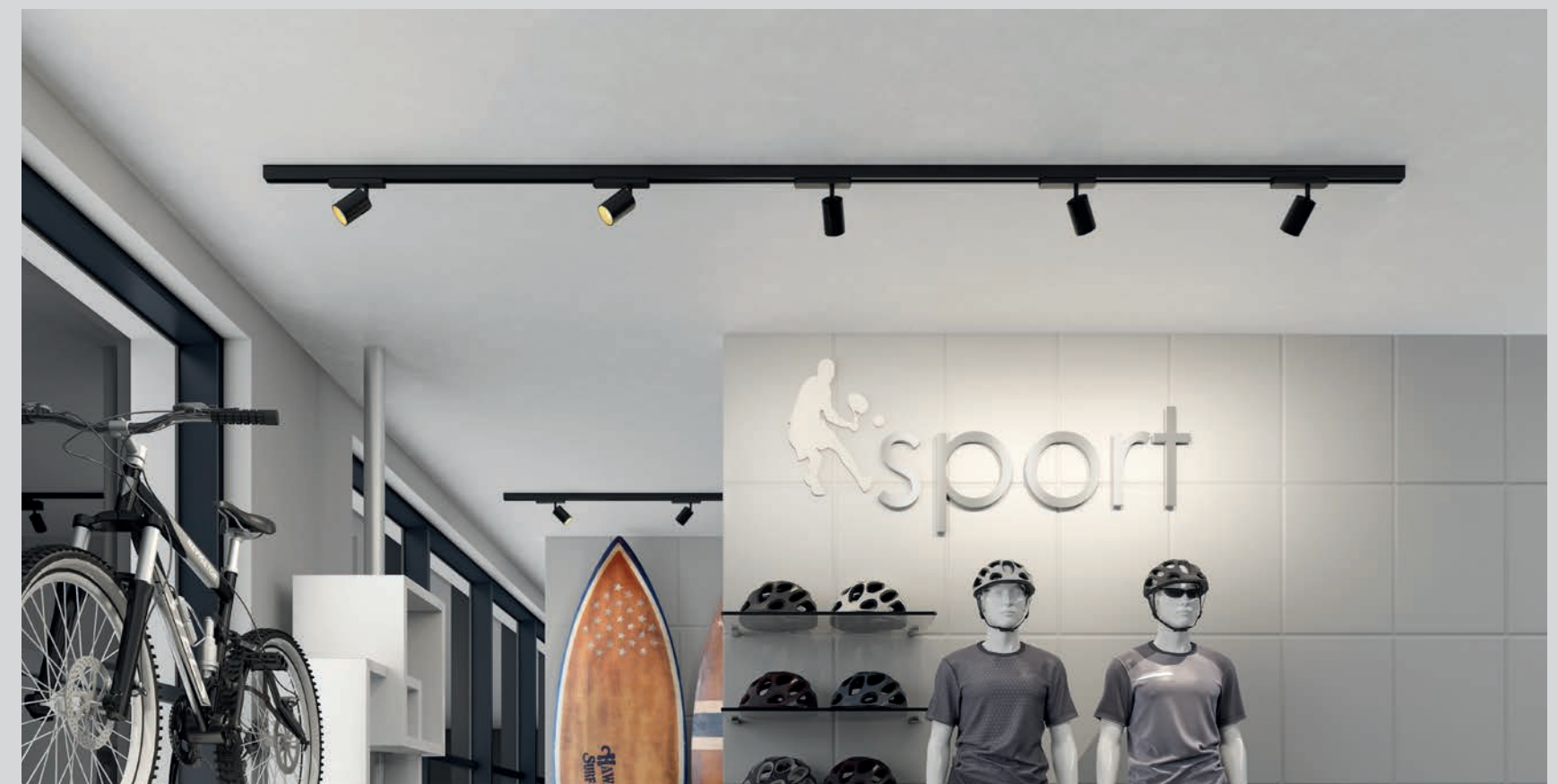



## MIKE GRANDE DA BINARIO

PROIETTORE / SPOTLIGHT

	36° (a richiesta 15°)* (a richiesta 50°)** <i>(15° on request)* (50° on request)**</i>	
	3000K / 4000K	COLORE PROFILO / BODY COLOUR
	40	<b>02</b> Nero opaco
	93 (a richiesta >80) <i>(&gt;80 on request)</i>	<b>08</b> Bianco satinato
	A+	COLORE ANELLO / RING COLOUR
	1	<b>02</b> Nero opaco
	Driver incluso <i>Driver included</i>	<b>A</b> AN002.08 Anello bianco (escluso) / <i>White ring (not included)</i> AN002.13 Anello oro (escluso) / <i>Gold ring (not included)</i>

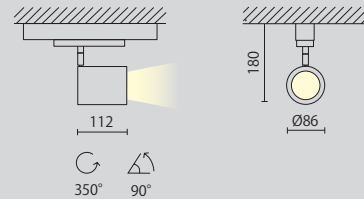

CODICE	W	Lm (3000K)	€ (IVA esclusa) / (VAT excluded)
A2-612.17.../D	17	2240	199,00
A2-612.22.../D	23	2830	199,00
A2-612.31.../D	31	3575	199,00

\*cod. PA 023-15 / \*\*cod. PA 023-50



## MIKE GRANDE 230V

PROIETTORE / SPOTLIGHT

	36° (a richiesta 15°)* (a richiesta 50°)** <i>(15° on request)* (50° on request)**</i>	
	3000K / 4000K	COLORE PROFILO / BODY COLOUR
	20	<b>02</b> Nero opaco
	>80	<b>08</b> Bianco satinato
	A+	COLORE ANELLO / RING COLOUR
	1	<b>02</b> Nero opaco
	Driver non richiesto <i>Driver not requested</i>	<b>A</b> AN002.08 Anello bianco (escluso) / <i>White ring (not included)</i> AN002.13 Anello oro (escluso) / <i>Gold ring (not included)</i>

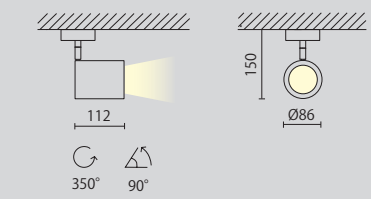

CODICE	W	Lm (3000K)	€ (IVA esclusa) / (VAT excluded)
A2-612.15AC	15	1350	170,00

\*cod. PA 023-15 / \*\*cod. PA 023-50



## MIKE GRANDE 230V DA BINARIO

PROIETTORE / SPOTLIGHT

	36° (a richiesta 15°)* (a richiesta 50°)** <i>(15° on request)* (50° on request)**</i>	
	3000K / 4000K	COLORE PROFILO / BODY COLOUR
	20	<b>02</b> Nero opaco
	>80	<b>08</b> Bianco satinato
	A+	COLORE ANELLO / RING COLOUR
	1	<b>02</b> Nero opaco
	Driver non richiesto <i>Driver not requested</i>	<b>A</b> AN002.08 Anello bianco (escluso) / <i>White ring (not included)</i> AN002.13 Anello oro (escluso) / <i>Gold ring (not included)</i>

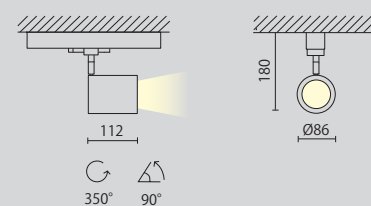







CODICE	W	Lm (3000K)	€ (IVA esclusa) / (VAT excluded)
A2-612.15AC.../D	15	1350	170,00

\*cod. PA 023-15 / \*\*cod. PA 023-50



TOV  
PROIETTORE / SPOTLIGHT

-  40° (a richiesta 20°)\*  
(20° on request)\*
-  3000K / 4000K
-  IP 40
-  93 (a richiesta >80)  
(>80 on request)
-  A+
-  1
-  Driver incluso  
Driver included

COLORE PROFILO / BODY COLOUR

**02** Nero opaco

**08** Bianco satinato

COLORE ANELLO / RING COLOUR

**02** Nero opaco



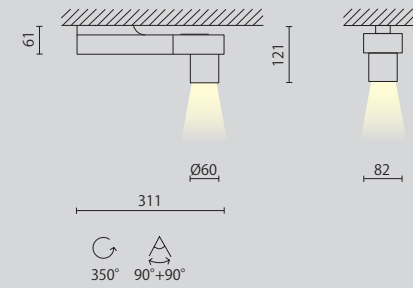



**A** AN001.08 Anello bianco (escluso) / White ring (not included)  
AN001.13 Anello oro (escluso) / Gold ring (not included)



CODICE	W	Lm (3000K)	€ (IVA esclusa) / (VAT excluded)
A2-209...	10	1320	150,00

\*cod. PA 022-20

TOV DA BINARIO  
PROIETTORE / SPOTLIGHT

-  40° (a richiesta 20°)\*  
(20° on request)\*
-  3000K / 4000K
-  IP 40
-  93 (a richiesta >80)  
(>80 on request)
-  A+
-  1
-  Driver incluso  
Driver included

COLORE PROFILO / BODY COLOUR

**02** Nero opaco

**08** Bianco satinato

COLORE ANELLO / RING COLOUR

**02** Nero opaco

**A** AN001.08 Anello bianco (escluso) / White ring (not included)  
AN001.13 Anello oro (escluso) / Gold ring (not included)

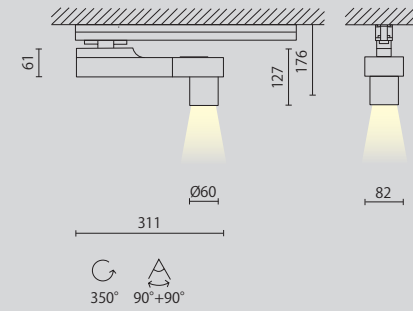

CODICE	W	Lm (3000K)	€ (IVA esclusa) / (VAT excluded)
A2-209.../D	10	1320	170,00











\*cod. PA 022-20







MUR Ø60 230V  
PROIETTORE / SPOTLIGHT



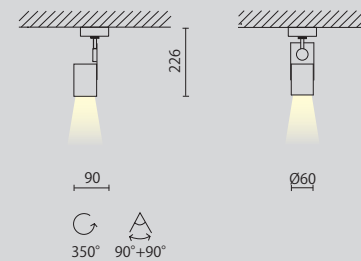







-  30°
  -  TC 3000K / 4000K
  -  IP 40
  -  CRI >80
  -  EEI A+
  -  RG 1
  -  D Driver non richiesto  
Driver not requested
-  02 Nero opaco
  -  08 Bianco satinato
  -  08/02 Bianco satinato/Nero opaco



CODICE	W	Lm (3000K)	€ (IVA esclusa) / (VAT excluded)
A2-607.08AC...	8	704	170,00



MUR Ø60 DA BINARIO  
PROIETTORE / SPOTLIGHT

-  30°
  -  TC 3000K / 4000K
  -  IP 40
  -  CRI 93 (a richiesta >80)  
(>80 on request)
  -  EEI A++
  -  RG 1
  -  D Driver incluso  
Driver included
-  02 Nero opaco
  -  08 Bianco satinato
  -  08/02 Bianco satinato/Nero opaco

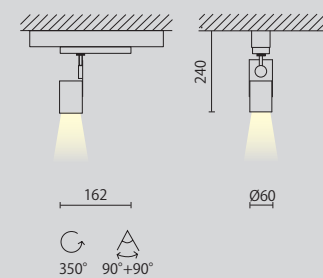

CODICE	W	Lm (3000K)	€ (IVA esclusa) / (VAT excluded)
A2-207.../D	10	1320	190,00





MUR Ø120 230V  
PROIETTORE / SPOTLIGHT

- 40° (a richiesta 24°)\*  
(24° on request)\*
- TC 3000K / 4000K
- IP 40
- CRI >80
- EEI A+
- RG 1
- Driver non richiesto  
Driver not requested

- 02 Nero opaco
- 08 Bianco satinato
- 08/02 Bianco satinato/Nero opaco

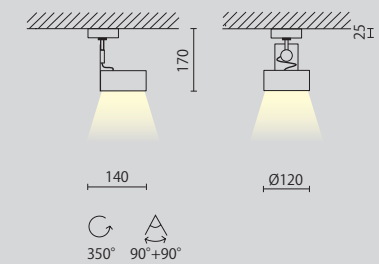

CODICE	W	Lm (3000K)	€ (IVA esclusa) / (VAT excluded)
A2-606.15...	15	1350	170,00

\*cod. PA 014-24



MUR Ø120 DA BINARIO  
PROIETTORE / SPOTLIGHT

- 40° (a richiesta 24°)\*  
(24° on request)\*
- TC 3000K / 4000K
- IP 40
- CRI 93 (a richiesta >80)  
(>80 on request)
- EEI A++
- RG 1
- Driver incluso  
Driver included

- 02 Nero opaco
- 08 Bianco satinato
- 08/02 Bianco satinato/Nero opaco

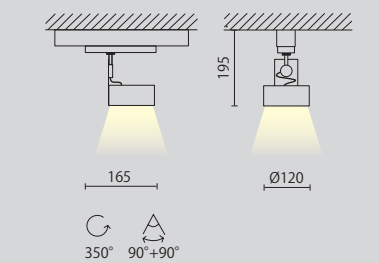

CODICE	W	Lm (3000K)	€ (IVA esclusa) / (VAT excluded)
A2-606.17.../D	17	2240	168,00
A2-606.23.../D	23	3025	178,00

\*cod. PA 014-24



MUR Ø60 230V DA BINARIO  
PROIETTORE / SPOTLIGHT

- 30°
  - 3000K / 4000K
  - 40
  - >80
  - A+
  - 1
  - Driver non richiesto  
Driver not requested
- 02 Nero opaco
  - 08 Bianco satinato
  - 08/02 Bianco satinato/Nero opaco

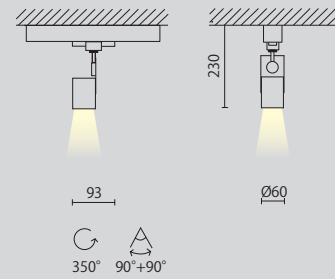

MUR Ø120 230V DA BINARIO  
PROIETTORE / SPOTLIGHT

- 40° (a richiesta 24°)\*  
(24° on request)\*
  - 3000K / 4000K
  - 40
  - >80
  - A+
  - 1
  - Driver non richiesto  
Driver not requested
- 02 Nero opaco
  - 08 Bianco satinato
  - 08/02 Bianco satinato/Nero opaco

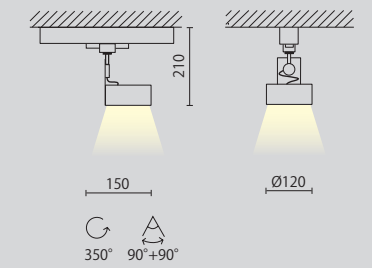

CODICE	W	Lm (3000K)	€ (IVA esclusa) / (VAT excluded)
A2-607.08AC.../D	8	704	170,00

CODICE	W	Lm (3000K)	€ (IVA esclusa) / (VAT excluded)
A2-606.15.../D	15	1350	170,00

\*cod. PA 014-24

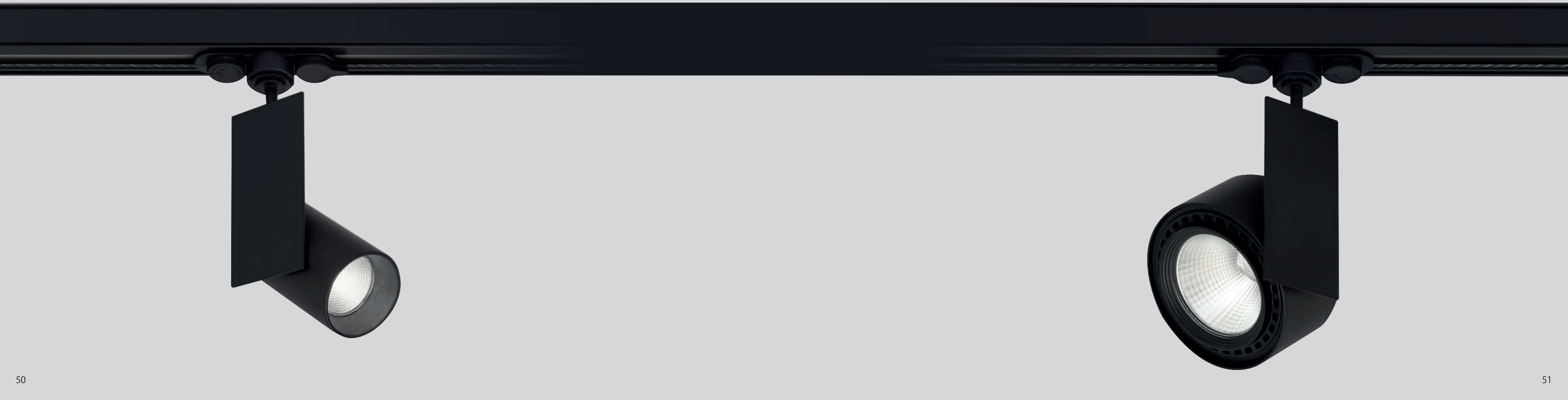



ARCO 230V DA BINARIO  
PROIETTORE / SPOTLIGHT

- 36° (a richiesta 24°)\* (a richiesta 15°)\*\*  
(24° on request)\* (15° on request)\*\*
- 3000K / 4000K
- 40
- >80
- A+
- 1
- Driver non richiesto  
Driver not requested

- 02 Nero opaco
- 08 Bianco satinato

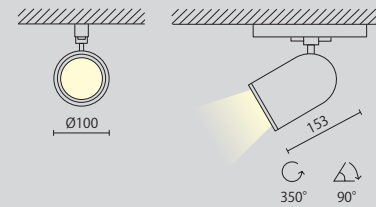

CODICE	W	Lm (3000K)	€ (IVA esclusa) / (VAT excluded)
A2-629.20AC.../D	20	1800	135,00
A2-629.30AC.../D	30	2700	145,00

\*cod. PA 017-24 / \*\*cod. PA 017-15



ARCO DA BINARIO  
PROIETTORE / SPOTLIGHT

- 36° (a richiesta 24°)\* (a richiesta 15°)\*\*  
(24° on request)\* (15° on request)\*\*
- 3000K / 4000K
- 40
- 93 (a richiesta >80)  
(>80 on request)
- A+
- 1
- Driver incluso  
Driver included

- 02 Nero opaco
- 08 Bianco satinato

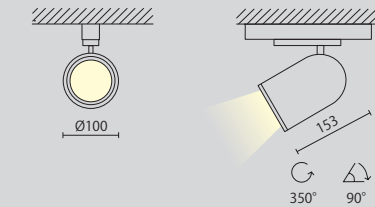

CODICE	W	Lm (3000K)	€ (IVA esclusa) / (VAT excluded)
A2-628.17.../D	17	2240	180,00
A2-628.23.../D	23	2870	188,00

\*cod. PA 017-24 / \*\*cod. PA 017-15



ARCO 230V  
PROIETTORE / SPOTLIGHT

- 36° (a richiesta 24°)\* (a richiesta 15°)\*\*  
(24° on request)\* (15° on request)\*\*
- 3000K / 4000K
- 40
- >80
- A+
- 1
- Driver non richiesto  
Driver not requested

- 02 Nero opaco
- 08 Bianco satinato

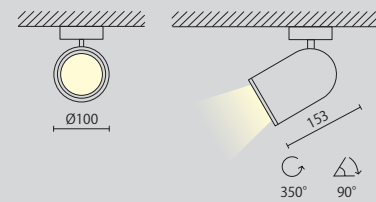

CODICE	W	Lm (3000K)	€ (IVA esclusa) / (VAT excluded)
A2-629.20AC...	20	1800	135,00
A2-629.30AC...	30	2700	145,00

\*cod. PA 017-24 / \*\*cod. PA 017-15



ARCO INCASSO  
PROIETTORE / SPOTLIGHT

- 36° (a richiesta 24°)\* (a richiesta 15°)\*\*  
(24° on request)\* (15° on request)\*\*
- 3000K / 4000K
- 40
- 93 (a richiesta >80)  
(>80 on request)
- A+
- 1
- Driver incluso  
Driver included

- 02 Nero opaco
- 08 Bianco satinato

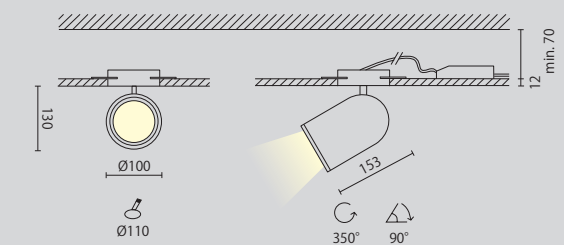

DISPONIBILE DA OTTOBRE 2017  
AVAILABLE FROM OCTOBER 2017

CODICE	W	Lm (3000K)	€ (IVA esclusa) / (VAT excluded)	... / DIMM2-3 (Dimmerabile)
A5-628.17...	17	2240	180,00	220,00
A5-628.24...	24	3025	188,00	228,00

\*cod. PA 017-24 / \*\*cod. PA 017-15



Farmacia, design Andrea Zanini\_studio AZdesign



## ZETA 85

PROIETTORE / SPOTLIGHT

- 36° (a richiesta 24°)\* (a richiesta 15°)\*\*  
(24° on request)\* (15° on request)\*\*
- 3000K / 4000K
- 40
- 93 (a richiesta >80)  
(>80 on request)
- A++
- 1
- Driver incluso  
Driver included

- 02 Nero opaco
- 08 Bianco satinato

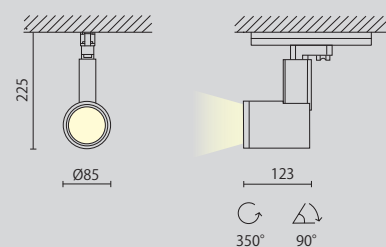

CODICE	W	Lm (3000K)	€ (IVA esclusa) / (VAT excluded)
A2-640.18...	18	2240	155,00

\*cod. PA 018-24 / \*\*cod. PA 018-15

## ZETA 130

PROIETTORE / SPOTLIGHT

- 36° (a richiesta 24°)\* (a richiesta 15°)\*\*  
(24° on request)\* (15° on request)\*\*
- 3000K / 4000K
- 40
- (vedi tabella)  
(see table)
- A+ (40W) / A++
- 1
- Driver incluso  
Driver included

- 02 Nero opaco
- 08 Bianco satinato

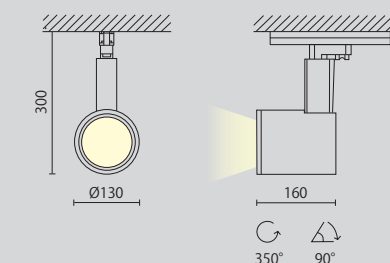

CODICE	W	Lm (3000K)	CRI	€ (IVA esclusa) / (VAT excluded)
A2-644.40AC...	40	3600	>80	160,00
A2-644.38...	38	4425	93 (a richiesta >80) / (>80 on request)	180,00
A2-644.44...	44	4975	93 (a richiesta >80) / (>80 on request)	185,00
A2-644.46...	46	5790	93 (a richiesta >80) / (>80 on request)	195,00

\*cod. PA 020-24 / \*\*cod. PA 020-15



## ZETA 110

PROIETTORE / SPOTLIGHT

- 36° (a richiesta 24°)\* (a richiesta 15°)\*\*  
(24° on request)\* (15° on request)\*\*
- 3000K / 4000K
- 40
- (vedi tabella)  
(see table)
- A+ (30W) / A++
- 1
- Driver incluso  
Driver included

- 02 Nero opaco
- 08 Bianco satinato

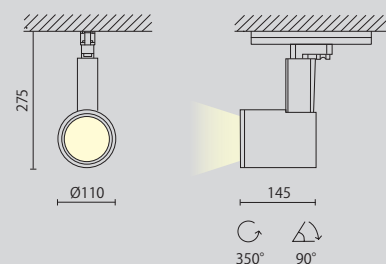

CODICE	W	Lm (3000K)	CRI	€ (IVA esclusa) / (VAT excluded)
A2-642.30AC...	30	2700	>80	149,00
A2-642.25...	25	3020	93 (a richiesta >80) / (>80 on request)	159,00
A2-642.34...	34	3860	93 (a richiesta >80) / (>80 on request)	173,00
A2-642.38...	38	4425	93 (a richiesta >80) / (>80 on request)	180,00

\*cod. PA 019-24 / \*\*cod. PA 019-15





## HARRY

PROIETTORE / SPOTLIGHT

- 40° (a richiesta 24°)\*  
(24° on request)\*
- 3000K / 4000K
- IP 40
- CRI 93 (a richiesta >80)  
(>80 on request)
- EEI A++
- RG 1
- Driver incluso  
Driver included

- 02 Nero opaco
- 08 Bianco satinato

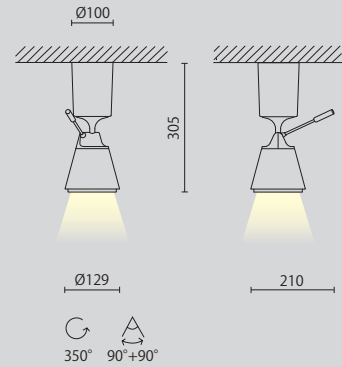

CODICE	W	Lm (3000K)	€ (IVA esclusa) / (VAT excluded)
A2-608.17...	17	2240	190,00

\*cod. PA 014-24



## HARRY DA BINARIO

PROIETTORE / SPOTLIGHT

- 40° (a richiesta 24°)\*  
(24° on request)\*
- 3000K / 4000K
- IP 40
- CRI 93 (a richiesta >80)  
(>80 on request)
- EEI A++
- RG 1
- Driver incluso  
Driver included

- 02 Nero opaco
- 08 Bianco satinato

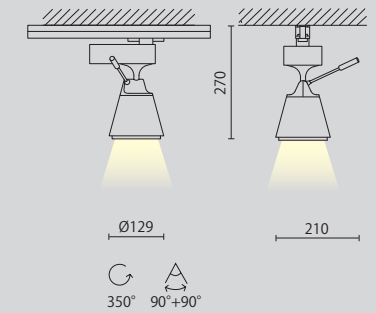

CODICE	W	Lm (3000K)	€ (IVA esclusa) / (VAT excluded)
A2-608.17.../D	17	2240	190,00

\*cod. PA 014-24



## HARRY 230V DA BINARIO

PROIETTORE / SPOTLIGHT

- 40° (a richiesta 24°)\*  
(24° on request)\*
- 3000K / 4000K
- IP 40
- CRI >80
- EEI A+
- RG 1
- Driver non richiesto  
Driver not requested

- 02 Nero opaco
- 08 Bianco satinato

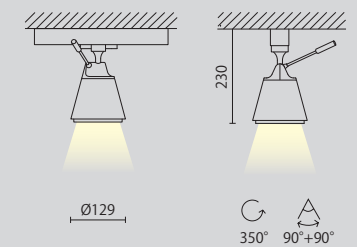

CODICE	W	Lm (3000K)	€ (IVA esclusa) / (VAT excluded)
A2-604.15AC.../D	15	1350	160,00

\*cod. PA 014-24

CODICE	DESCRIZIONE / DESCRIPTION	€ (IVA esclusa) / (VAT excluded)
6901	Binario lunghezza m 1. Colore: 01 - 02 - 20 Track, 1m long. Colours: 01 - 02 - 20	35,00
6902	Binario lunghezza m 2. Colore: 01 - 02 - 20 Track, 2m long. Colours: 01 - 02 - 20	68,00
6903	Binario lunghezza m 3. Colore: 01 - 02 - 20 Track, 3m long. Colours: 01 - 02 - 20	101,00
6904	Alimentazione a destra. Colore: 01 - 02 - 20 Right feed connector. Colours: 01 - 02 - 20	13,00
6905	Alimentazione a sinistra. Colore: 01 - 02 - 20 Left feed connector. Colours: 01 - 02 - 20	13,00
6906	Giunto lineare. Colore: 01 - 02 In-line connector. Colours: 01 - 02	8,60
6907	Giunto lineare senza contatti. Colore: 01 - 02 In-line connector, mechanical only. Colours: 01 - 02	5,60
6908	Giunto flessibile. Colore: 01 - 02 - 20 Flexible connector. Colours: 01 - 02 - 20	34,40
6909	Giunto L interno. Colore: 01 - 02 - 20 Internal connector. Colours: 01 - 02 - 20	29,00
6910	Giunto L esterno. Colore: 01 - 02 - 20 External connector. Colours: 01 - 02 - 20	29,00
6911	Giunto T destro. Colore: 01 - 02 - 20 T connector right hand. Colours: 01 - 02 - 20	43,00
6912	Giunto T sinistro. Colore: 01 - 02 - 20 T connector left hand. Colours: 01 - 02 - 20	43,00
6913	Giunto X. Colore: 01 - 02 - 20 X connector. Colours: 01 - 02 - 20	58,00
6914	Alimentazione centrale o giunto lineare. Colore: 01 - 02 - 20 Central feed connector or central connector. Colours: 01 - 02 - 20	25,50
6915	Tappo per fine binario. Colore: 01 - 02 - 20 End cap. Colours: 01 - 02 - 20	1,40
6916	Coperchio per binario cm 100. Colore: 01 - 02 Track cover plate, cm 100. Colours: 01 - 02	3,60
6917	Sospensione di cm 200 con rosone. Colore: 01 - 02 Cable suspension kit with ceiling cup, cm 200. Colours: 01 - 02	7,00
6918	Supporto a soffitto. Ceiling clips.	5,80



01	Bianco
02	Nero
20	Anodizzato naturale

# DUE

## BINARIO / TRACKS

### Rispettare la continuità del neutro.

Porre particolare attenzione nella scelta dei giunti necessari alla composizione, tutti disponibili in versione destra e sinistra, avendo cura di rispettare la stessa posizione della linea neutra collocata lateralmente sul giunto evidenziata nel disegno con il colore BLU.

### Respect the continuity of the neutral.

Pay particular attention when choosing the joints required for assembly, all available in left and right versions, making sure to place them in the same position as the neutral line placed laterally on the joints highlighted in BLUE on the diagram.

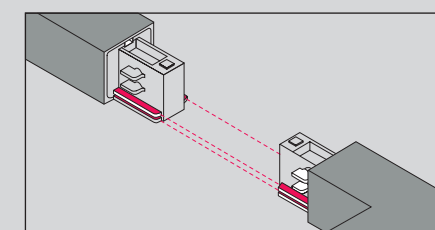
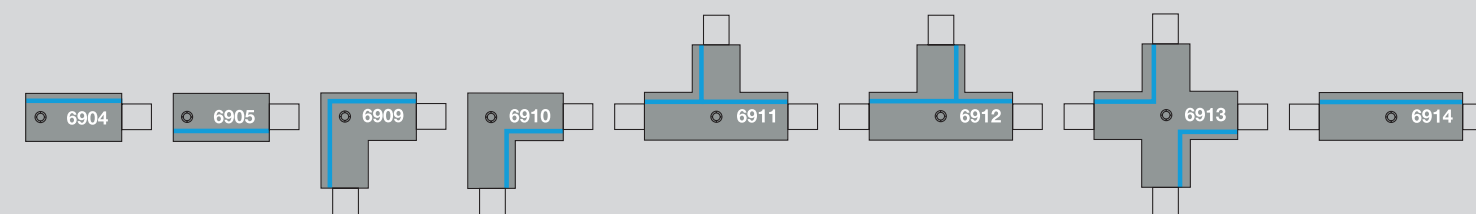

Un'ulteriore prova che si può fare dal punto di vista visivo, atta a capire se la scelta dei giunti utilizzati nella composizione è quella corretta, consiste nel mantenere direzionate nello stesso senso, e per tutta la lunghezza della composizione, le due guide laterali in plastica e quella singola presente sul lato opposto del giunto.

A further visual test that can be carried out in order to check whether the choice of the joint used in the assembly is the right one is to keep the two plastic side runners and the single runner on the other side of the joint facing the same direction all along the track.

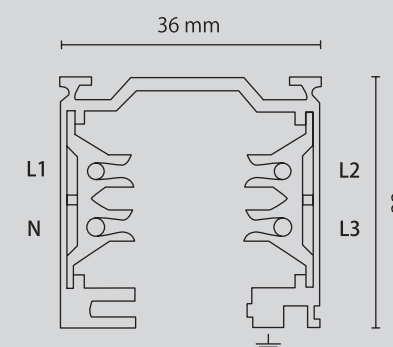

### BINARI STANDARD (ON/OFF) / STANDARD TRACKS (ON/OFF)

Schema di collegamento / Connection scheme

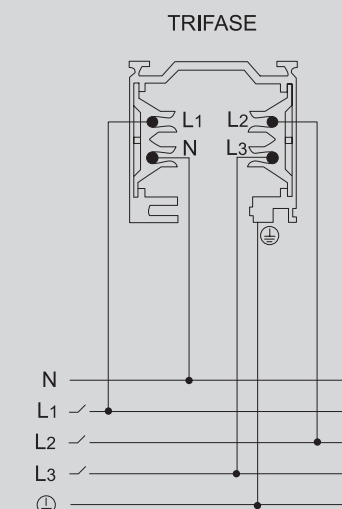





INCASSI  
RECESSED

**BEN**  
64

**PALACE**  
68

**ROY**  
69

**JACK**  
70

**GIO'**  
72

**FLO**  
73

**BISS**  
73

**IRO**  
74

**IROTO**  
76

**EDO**  
76

**CHIC**  
78

**MIKE**  
80

**MIKE GRANDE**  
81

**EK**  
82

**COMFORT**  
82

**IDRO**  
83

**DEDILUS**  
84

**ZI**  
88

**VELO**  
89

**AMBO**  
90



**BEN** Ø413 CON BORDO / WITH TRIM  
INCASSO / RECESSED

- 120°
- TC 3000K / 4000K
- IP 40
- CRI >80
- EEI A++
- RG 0
- D Driver incluso  
Driver included

08 Bianco satinato

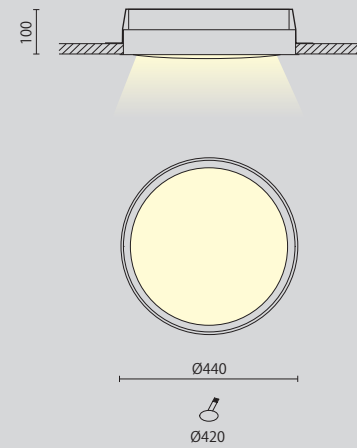

CODICE	W	Lm (3000K)	€ (IVA esclusa) / (VAT excluded)	... /DIMM2-3 (Dimmerabile)	... /EM (Emergenza)
A5-692...	25	3610	390,00	430,00	530,00



**BEN** Ø413 SENZA BORDO / TRIMLESS  
INCASSO / RECESSED

- 120°
- TC 3000K / 4000K
- IP 40
- CRI >80
- EEI A++
- RG 0
- D Driver incluso  
Driver included

08 Bianco satinato

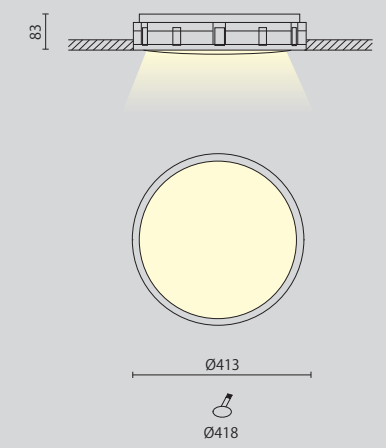

CODICE	W	Lm (3000K)	€ (IVA esclusa) / (VAT excluded)	... /DIMM2-3 (Dimmerabile)	... /EM (Emergenza)
A5-672...	25	3610	390,00	430,00	530,00



**BEN** Ø764 CON BORDO / WITH TRIM  
INCASSO / RECESSED

- 120°
- TC 3000K / 4000K
- IP 40
- CRI >80
- EEI A++
- RG 0
- D Driver incluso  
Driver included

08 Bianco satinato

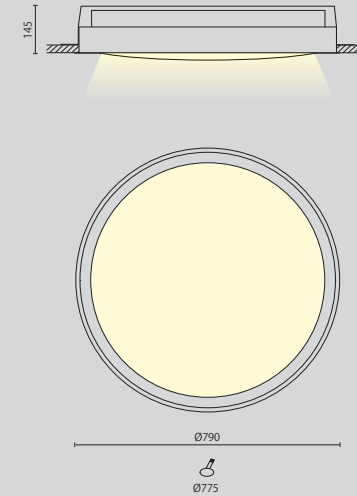

CODICE	W	Lm (3000K)	€ (IVA esclusa) / (VAT excluded)	... /DIMM2-3 (Dimmerabile)	... /EM (Emergenza)
A5-693.70...	70	8800	690,00	730,00	830,00



**BEN** Ø764 SENZA BORDO / TRIMLESS  
INCASSO / RECESSED

- 120°
- TC 3000K / 4000K
- IP 40
- CRI >80
- EEI A++
- RG 0
- D Driver incluso  
Driver included

08 Bianco satinato

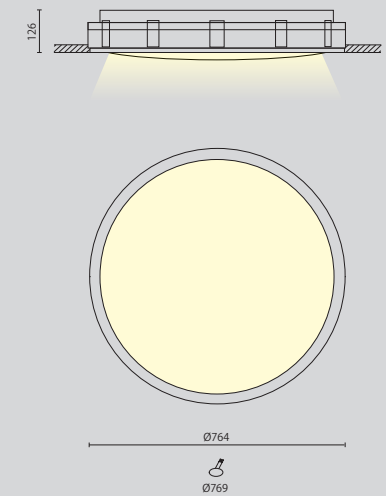

CODICE	W	Lm (3000K)	€ (IVA esclusa) / (VAT excluded)	... /DIMM2-3 (Dimmerabile)	... /EM (Emergenza)
A5-673.70...	70	8800	690,00	730,00	830,00



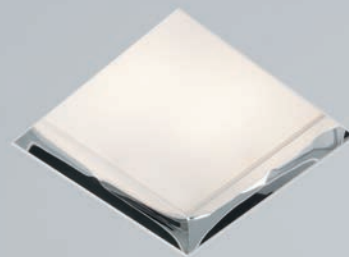

**PALACE** PRO SENZA BORDO / TRIMLESS  
INCASSO / RECESSED

- 100°
- TC 3000K / 4000K
- IP 43
- CRI >80
- EEI A++
- RG 0
- D Driver incluso / Driver included

- 08 Bianco satinato
- 14 Cromato

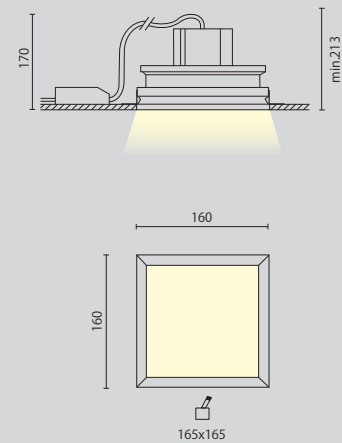

CODICE	W	Lm (3000K)	€ (IVA esclusa) / (VAT excluded)	... /DIMM2-3 (Dimmerabile)	... /EM (Emergenza)
A5-620.026...	25	3530	210,00	260,00	350,00

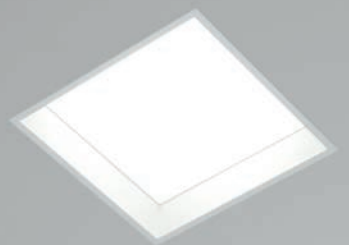

**PALACE** PRO CON BORDO  
INCASSO / RECESSED

- 100°
- TC 3000K / 4000K
- IP 43
- CRI >80
- EEI A++
- RG 0
- D Driver incluso / Driver included

- 08 Bianco satinato
- 08/14 Bianco satinato/Cromato

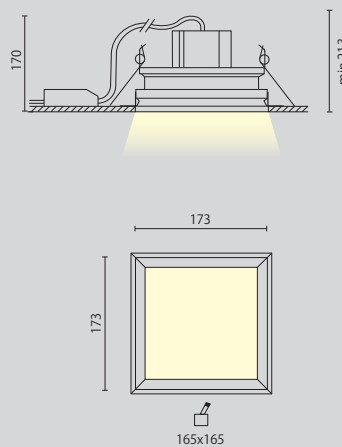

CODICE	W	Lm (3000K)	€ (IVA esclusa) / (VAT excluded)	... /DIMM2-3 (Dimmerabile)	... /EM (Emergenza)
A5-621.026...	25	3530	210,00	260,00	350,00



**ROY**  
INCASSO / RECESSED

- 42° (a richiesta 20°)\* / (20° on request)\*
- TC 3000K / 4000K
- IP 23
- CRI 93 (a richiesta >80) / (>80 on request)
- EEI A++
- RG 1
- D Driver incluso / Driver included

- 08 Bianco satinato

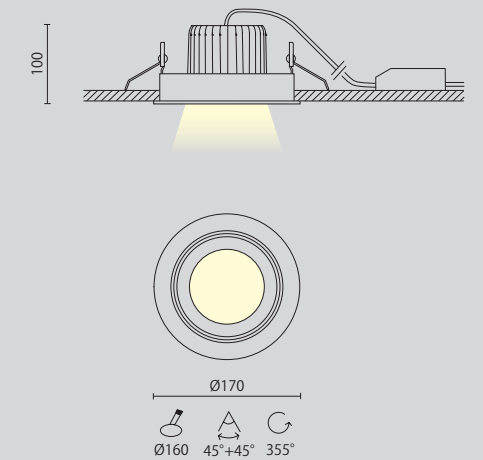

CODICE	W	Lm (3000K)	€ (IVA esclusa) / (VAT excluded)	... /DIMM2-3 (Dimmerabile)
A5-662.22...	17	2240	135,00	175,00
A5-662.28...	25	3025	140,00	190,00
A5-662.33...	33	3755	155,00	200,00

\*cod. PA 021-20



## JACK

INCASSO / RECESSED

- 42° (a richiesta 20°)\*  
(20° on request)\*
- TC 3000K
- IP 23
- CRI >80
- EEI A+
- RG 1
- D Driver incluso  
Driver included

08 Bianco satinato

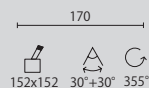
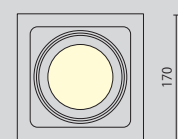
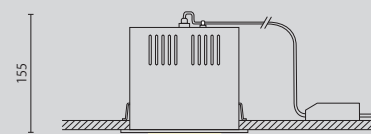

CODICE	W	Lm	€ (IVA esclusa) / (VAT excluded)	... /DIMM2-3 (Dimmerabile)
A5-663.22.30	22	2500	170,00	200,00
A5-663.28.30	28	3100	170,00	200,00
A5-663.33.30	33	3550	180,00	210,00

\*cod. PA 021-20



## JACK HIDE

INCASSO / RECESSED

- 42° (a richiesta 20°)\*  
(20° on request)\*
- TC 3000K
- IP 23
- CRI >80
- EEI A+
- RG 1
- D Driver incluso  
Driver included

08 Bianco satinato

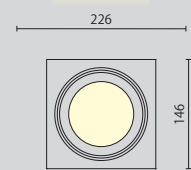
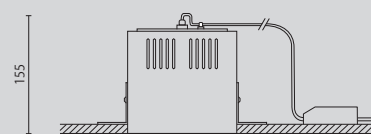

CODICE	W	Lm	€ (IVA esclusa) / (VAT excluded)	... /DIMM2-3 (Dimmerabile)
A5-664.22.30	22	2500	170,00	200,00
A5-664.28.30	28	3100	170,00	200,00
A5-664.33.30	33	3550	180,00	210,00

\*cod. PA 021-20





## GIO'

INCASSO / RECESSED

- 36°
- TC 3000K
- IP 43
- CRI >80
- EEI A+
- RG 1
- D Driver incluso  
Driver included

08 Bianco satinato

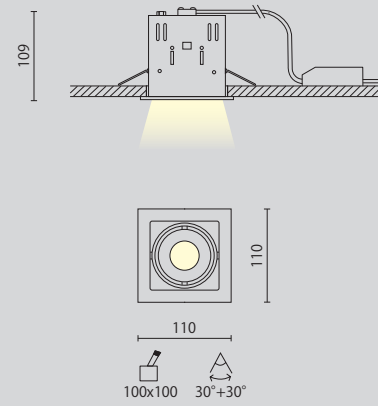

CODICE	W	Lm	€ (IVA esclusa) / (VAT excluded)	... /DIMM2-3 (Dimmerabile)
A5-665.07.30	7	670	69,00	99,00
A5-665.10.30	10	900	69,00	99,00



## FLO

INCASSO / RECESSED

- 36°
- TC 3000K
- IP 43
- CRI >80
- EEI A+
- RG 1
- D Driver incluso  
Driver included

08 Bianco satinato

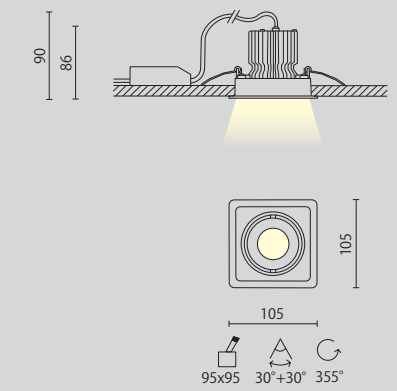

CODICE	W	Lm	€ (IVA esclusa) / (VAT excluded)	... /DIMM2-3 (Dimmerabile)
A5-670.07.30	7	670	69,00	99,00
A5-670.10.30	10	900	69,00	99,00



## GIO' HIDE

INCASSO / RECESSED

- 36°
- TC 3000K
- IP 43
- CRI >80
- EEI A+
- RG 1
- D Driver incluso  
Driver included

08 Bianco satinato

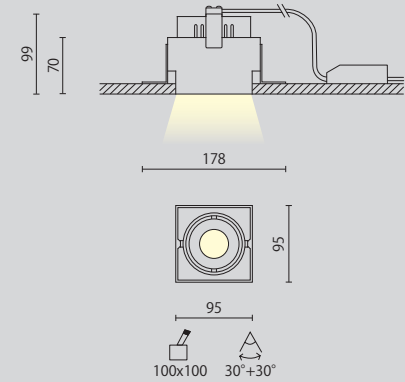

CODICE	W	Lm	€ (IVA esclusa) / (VAT excluded)	... /DIMM2-3 (Dimmerabile)
A5-666.07.30	7	670	69,00	99,00
A5-666.10.30	10	900	69,00	99,00



## BISS

INCASSO / RECESSED

- 44° (a richiesta 22°)\*  
(22° on request)\*
- TC 3000K
- IP 23
- CRI 93
- EEI A+
- RG 1
- D Driver incluso  
Driver included

08 Bianco satinato

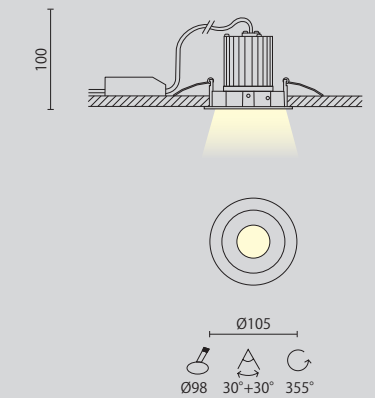

CODICE	W	Lm	€ (IVA esclusa) / (VAT excluded)	... /DIMM2-3 (Dimmerabile)
A5-680.07.30	7	560	85,00	115,00
A5-680.12.30	10	740	87,00	117,00
A5-680.15.30	15	920	89,00	119,00

\*cod. PA 024-22



IRO PICCOLO  
INCASSO / RECESSED

- 85°
- TC 3000K
- IP 43
- CRI >80
- EEI A+
- RG 0
- D Driver incluso  
Driver included

08 Bianco satinato

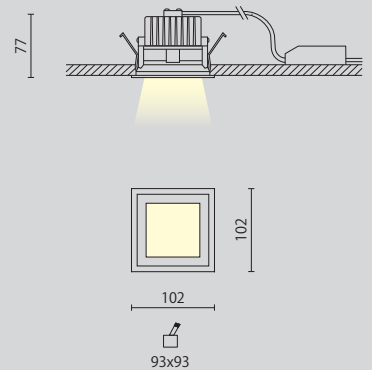

CODICE	W	Lm	€ (IVA esclusa) / (VAT excluded)	... /DIMM2-3 (Dimmerabile)
A5-668.11.30	11	950	85,00	125,00



IRO GRANDE  
INCASSO / RECESSED

- 95°
- TC 3000K
- IP 43
- CRI >80
- EEI A+
- RG 0
- D Driver incluso  
Driver included

08 Bianco satinato

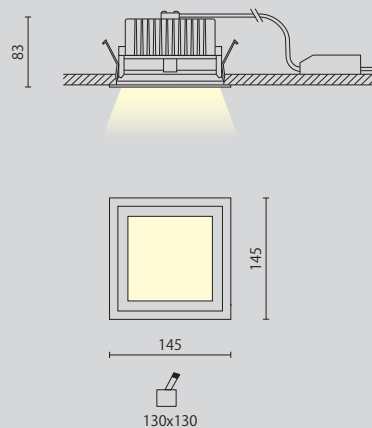

CODICE	W	Lm	€ (IVA esclusa) / (VAT excluded)	... /DIMM2-3 (Dimmerabile)
A5-669.25.30	25	2200	135,00	180,00

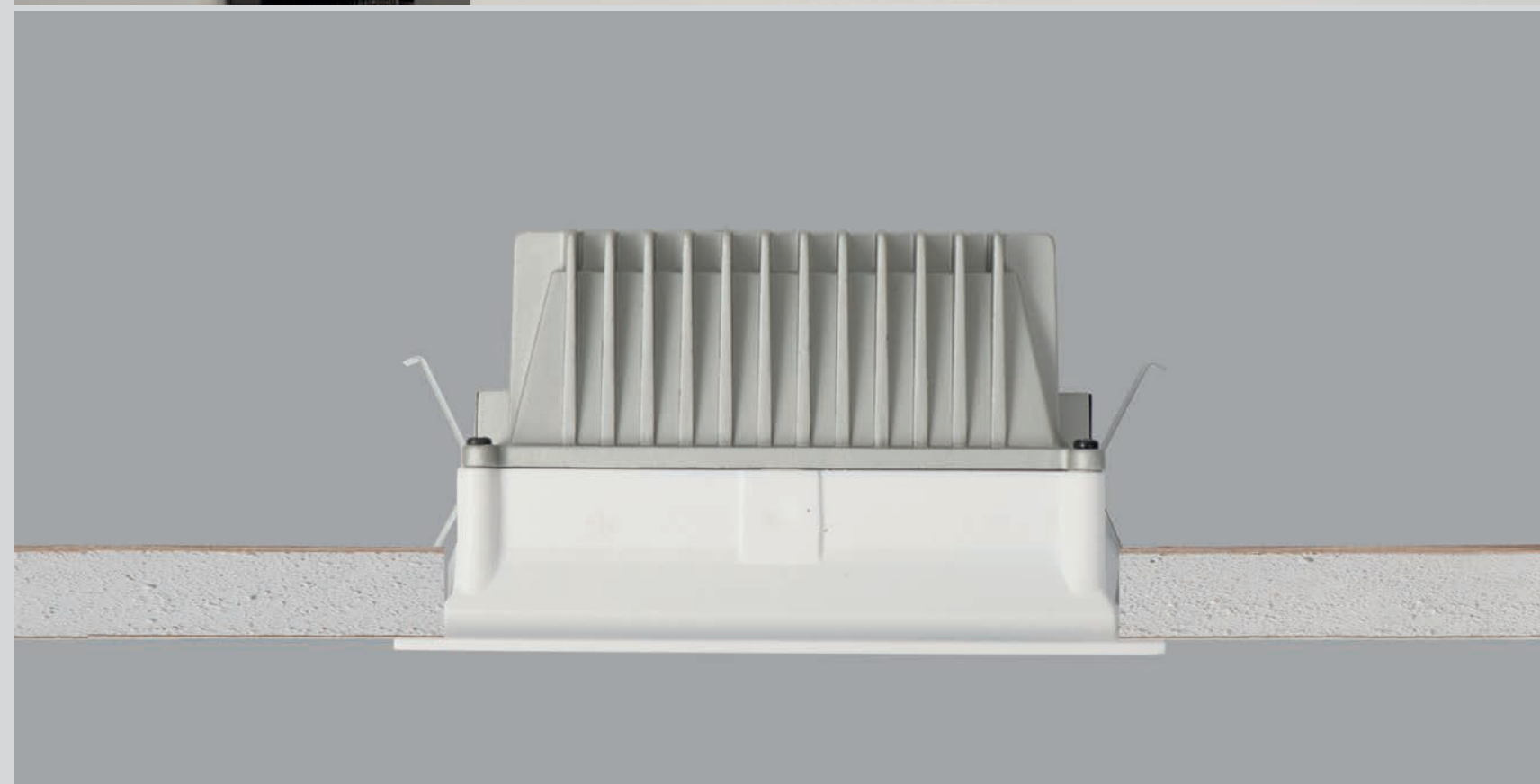



## IROTO

INCASSO / RECESSED

- 45° (a richiesta 35°)\*  
(35° on request)\*
- 3000K
- 43
- 93
- A+
- 0
- Driver incluso  
Driver included

08 Bianco satinato

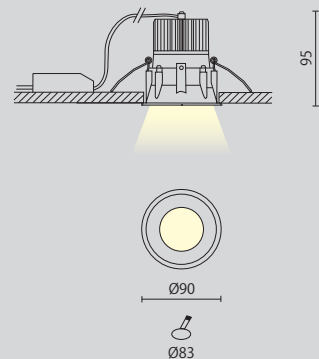

CODICE	W	Lm	€ (IVA esclusa) / (VAT excluded)	... /DIMM2-3 (Dimmerabile)
A5-629.10.30	10	865	90,00	130,00

\*cod. PA 026-35



## EDO GRANDE

INCASSO / RECESSED

- 40°
- 3000K
- 44
- 93
- A+
- 1
- Driver incluso  
Driver included

08 Bianco satinato

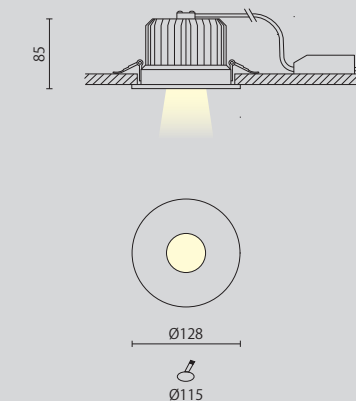

CODICE	W	Lm	€ (IVA esclusa) / (VAT excluded)	... /DIMM2-3 (Dimmerabile)
A5-676.15.30	15	1513	89,00	129,00



## EDO PICCOLO

INCASSO / RECESSED

- 40°
- 3000K
- 44
- 93
- A+
- 1
- Driver incluso  
Driver included

08 Bianco satinato

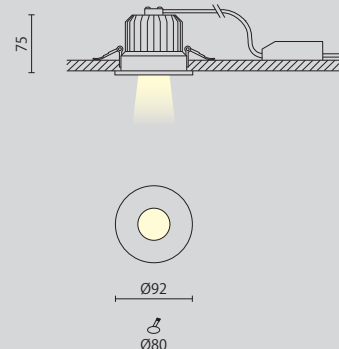

CODICE	W	Lm	€ (IVA esclusa) / (VAT excluded)	... /DIMM2-3 (Dimmerabile)
A5-675.10.30	7	900	79,00	119,00







CHIC TONDO  
INCASSO / RECESSED

- 50°
- 3000K / 4000K
- IP 44
- CRI 93
- EEI A+
- RG 1
- Driver incluso  
Driver included

- 02 Nero opaco
- 02/15 Nero opaco/Oro
- 08 Bianco satinato
- 08/02 Bianco satinato/Nero opaco

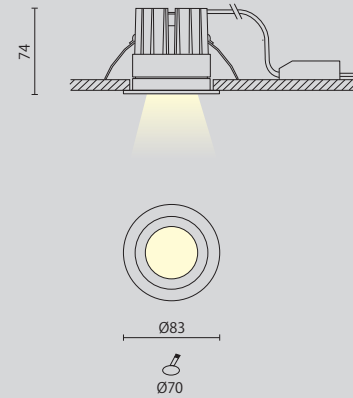

CHIC QUADRO  
INCASSO / RECESSED

- 40°
- 3000K / 4000K
- IP 44
- CRI 93
- EEI A+
- RG 1
- Driver incluso  
Driver included

- 02 Nero opaco
- 02/15 Nero opaco/Oro
- 08 Bianco satinato
- 08/02 Bianco satinato/Nero opaco

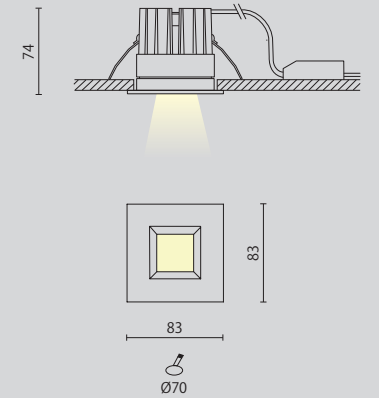

CODICE	W	Lm (3000K)	€ (IVA esclusa) / (VAT excluded)	... /DIMM2-3 (Dimmerabile)
A5-605.07...	7	560	88,00	128,00
A5-605.10...	10	740	88,00	128,00

CODICE	W	Lm (3000K)	€ (IVA esclusa) / (VAT excluded)	... /DIMM2-3 (Dimmerabile)
A5-606.07...	7	560	88,00	128,00
A5-606.10...	10	740	88,00	128,00



## MIKE

INCASSO / RECESSED

- 40° (a richiesta 20°)\*  
(20° on request)\*
- 3000K / 4000K
- IP 23
- CRI 93 (a richiesta >80)  
(>80 on request)
- EEL A++
- RG 1
- Driver incluso  
Driver included

COLORE PROFILO / BODY COLOUR

08 Bianco satinato

COLORE ANELLO / RING COLOUR

02 Nero opaco

A AN001.08 Anello bianco (escluso) / White ring (not included)  
AN001.13 Anello oro (escluso) / Gold ring (not included)

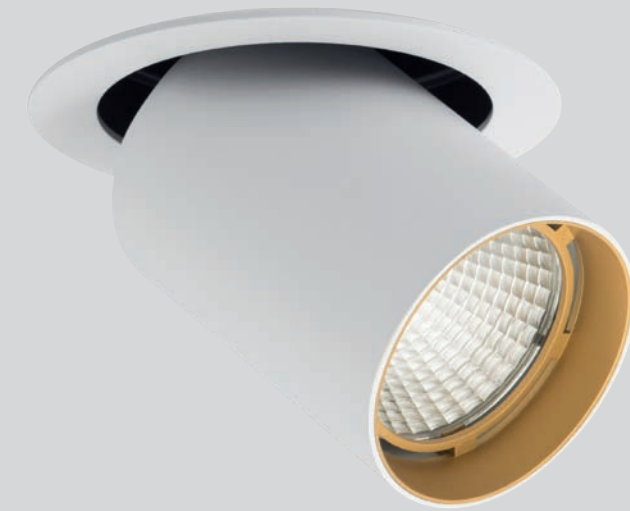
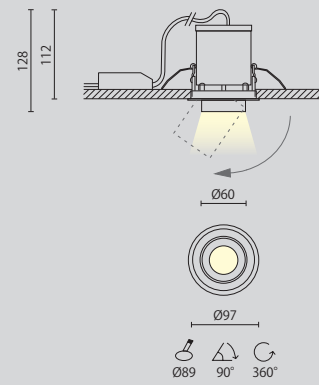

CODICE	W	Lm (3000K)	€ (IVA esclusa) / (VAT excluded)	... /DIMM2-3 (Dimmerabile)
A5-678.07...	7	900	130,00	170,00
A5-678.10...	10	1240	130,00	170,00

\*cod. PA 022-20



## MIKE GRANDE

INCASSO / RECESSED

- 36° (a richiesta 15°)\* (a richiesta 50°)\*\*  
(15° on request)\* (50° on request)\*\*
- 3000K / 4000K
- IP 23
- CRI 93 (a richiesta >80)  
(>80 on request)
- EEL A++
- RG 1
- Driver incluso  
Driver included

COLORE PROFILO / BODY COLOUR

08 Bianco satinato

COLORE ANELLO / RING COLOUR

02 Nero opaco

A AN002.08 Anello bianco (escluso) / White ring (not included)  
AN002.13 Anello oro (escluso) / Gold ring (not included)

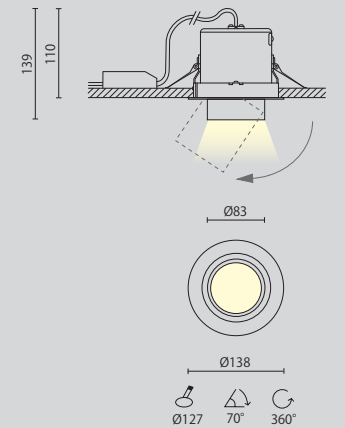

CODICE	W	Lm (3000K)	€ (IVA esclusa) / (VAT excluded)	... /DIMM2-3 (Dimmerabile)
A5-679.12...	12	1540	154,00	194,00
A5-679.18...	18	2140	159,00	199,00

\*cod. PA 023-15 / \*\*cod. PA 023-50

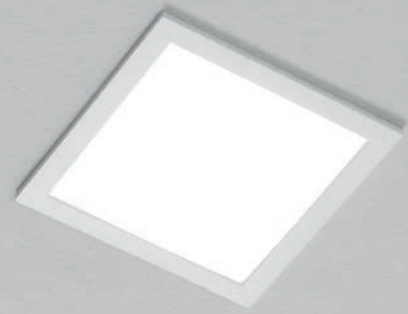

## EK

INCASSO / RECESSED

- 95°
- TC 3000K / 4000K
- IP 43
- CRI >80
- EEI A+
- RG 0
- D Driver non richiesto  
Driver not requested

08 Bianco satinato

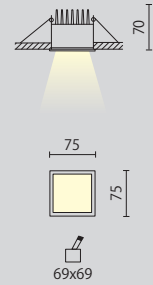

CODICE	W	Lm (3000K)	€ (IVA esclusa) / (VAT excluded)
A5-632.08AC...	8	700	94,00



## IDRO TONDO

INCASSO / RECESSED

- 30°
- TC 3000K
- IP 55
- CRI >80
- EEI A+
- RG 1
- D Driver incluso  
Driver included

08 Bianco satinato

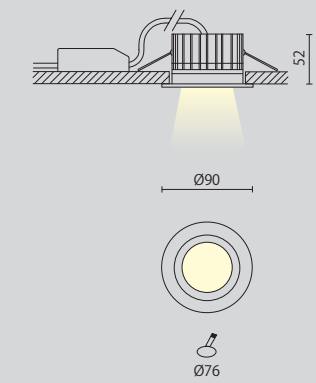

CODICE	W	Lm (3000K)	€ (IVA esclusa) / (VAT excluded)	... /DIMM2-3 (Dimmerabile)
A5-681.07.30	7	670	69,00	109,00
A5-681.10.30	10	900	79,00	119,00



## COMFORT

INCASSO / RECESSED

- 24°
- TC 3000K
- IP 44
- CRI 93
- EEI A++
- RG 0
- D Driver incluso  
Driver included

08 Bianco satinato

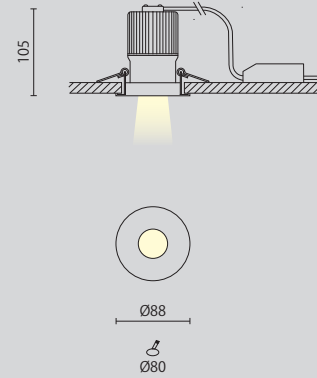

CODICE	W	Lm	€ (IVA esclusa) / (VAT excluded)	... /DIMM2-3 (Dimmerabile)
A5-677.07.30	7	900	70,00	110,00
A5-677.12.30	12	1522	74,00	114,00



## IDRO QUADRO

INCASSO / RECESSED

- 30°
- TC 3000K
- IP 55
- CRI >80
- EEI A+
- RG 1
- D Driver incluso  
Driver included

08 Bianco satinato

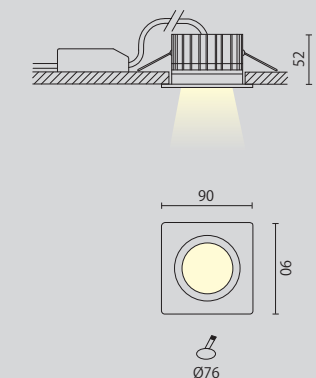

CODICE	W	Lm (3000K)	€ (IVA esclusa) / (VAT excluded)	... /DIMM2-3 (Dimmerabile)
A5-682.07.30	7	670	69,00	109,00
A5-682.10.30	10	900	79,00	119,00



DEDILUS PICCOLO TONDO  
INCASSO / RECESSED

- 45°
- TC 3000K
- IP 43
- CRI 93
- EEI A++
- RG 1
- D Driver incluso  
Driver included
- Gesso  
Plaster

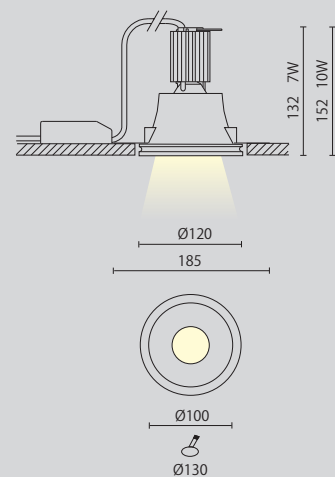

CODICE	W	Lm	€ (IVA esclusa) / (VAT excluded)
A5-687.07.30	7	780	85,00
A5-687.10.30	10	1025	85,00



DEDILUS PICCOLO QUADRO  
INCASSO / RECESSED

- 45°
- TC 3000K
- IP 43
- CRI 93
- EEI A++
- RG 1
- D Driver incluso  
Driver included
- Gesso  
Plaster

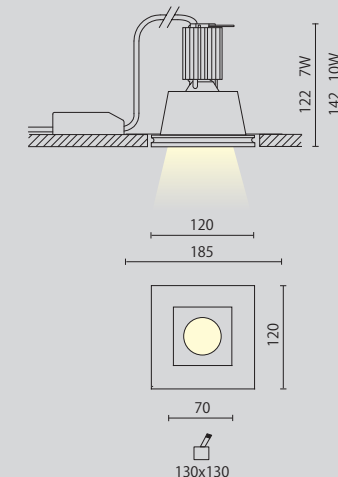

CODICE	W	Lm	€ (IVA esclusa) / (VAT excluded)
A5-685.07.30	7	780	85,00
A5-685.10.30	10	1025	85,00



DEDILUS PICCOLO TONDO  
INCASSO / RECESSED

- 45°
- TC 3000K
- IP 43
- CRI 93
- EEI A++
- RG 1
- D Driver incluso  
Driver included
- Gesso  
Plaster

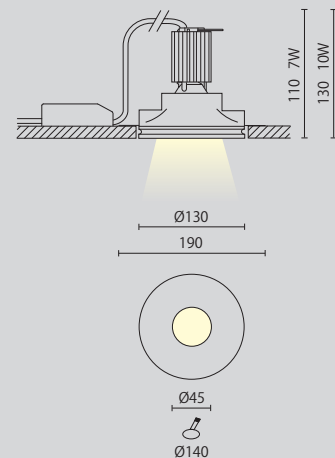

CODICE	W	Lm	€ (IVA esclusa) / (VAT excluded)
A5-688.07.30	7	780	85,00
A5-688.10.30	10	1025	85,00



DEDILUS PICCOLO QUADRO  
INCASSO / RECESSED

- 45°
- TC 3000K
- IP 43
- CRI 93
- EEI A++
- RG 1
- D Driver incluso  
Driver included
- Gesso  
Plaster

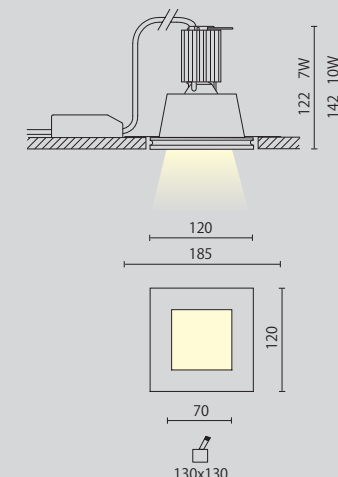

CODICE	W	Lm	€ (IVA esclusa) / (VAT excluded)
A5-686.07.30	7	780	85,00
A5-686.10.30	10	1025	85,00





## ZJ1

INCASSO / RECESSED

- 60°
- TC 3000K / 6000K
- IP 65
- CRI >80
- EEI A+
- RG 0
- D Driver 12Vdc escluso (p. 149)  
12Vdc driver not included (p. 149)
- 08 Bianco satinato
- 20 Anodizzato naturale

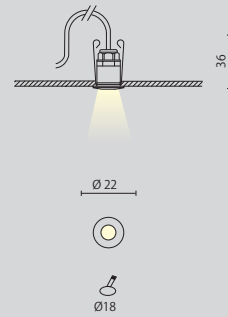

CODICE	W	Lm (3000K)	€ (IVA esclusa) / (VAT excluded)
A5-650...	0,3	25	36,00
0506.1	controcassa (esclusa) / flush box (not included)		14,00



## VELO TONDO

INCASSO / RECESSED

- 35°
- TC 3000K
- IP 55
- CRI >80
- EEI A+
- RG 0
- D Driver incluso  
Driver included
- 08 Bianco satinato

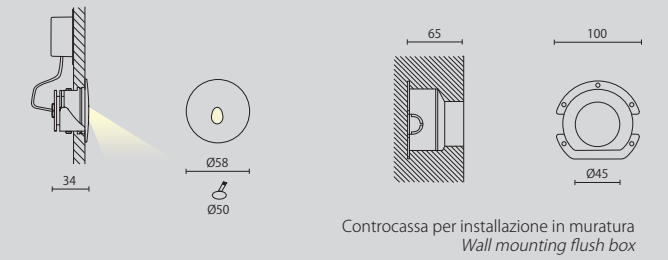

CODICE	W	Lm	€ (IVA esclusa) / (VAT excluded)
A5-600.03.30	3	160	74,00

controcassa inclusa / flush box included

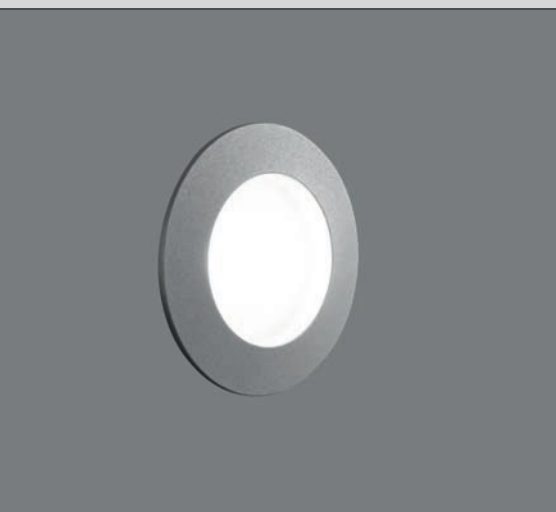

## ZJ2

INCASSO / RECESSED

- 40° (a richiesta 15°)\*  
(15° on request)\*
- TC 3000K
- IP 65
- CRI >80
- EEI A+
- RG 0
- D Driver incluso  
Driver included
- 08 Bianco satinato
- 20 Anodizzato naturale

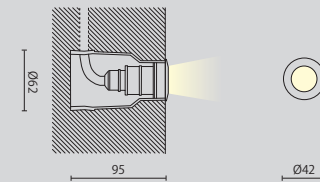

CODICE	W	Lm	€ (IVA esclusa) / (VAT excluded)
A5-651.30	3	150	66,00

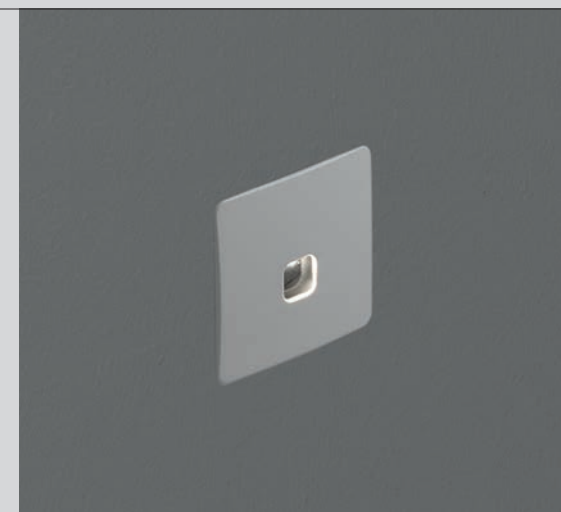

## VELO QUADRO

INCASSO / RECESSED

- 50°
- TC 3000K
- IP 55
- CRI >80
- EEI A+
- RG 0
- D Driver incluso  
Driver included
- 08 Bianco satinato

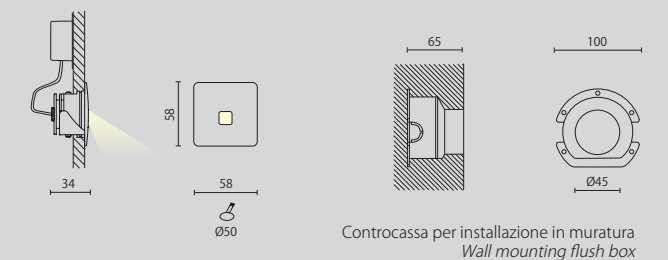

CODICE	W	Lm	€ (IVA esclusa) / (VAT excluded)
A5-601.03.30	3	160	74,00

controcassa inclusa / flush box included

\*cod. LE003-15  
controcassa per calcestruzzo inclusa / flush box for concrete included



## AMBO-A

INCASSO / RECESSED

- 45° (a richiesta 25°)\*  
(25° on request)\*
- TC 3000K
- IP 40
- CRI >80
- EEI A+
- RG 1
- D Driver incluso  
Driver included

- 16 Bronzo anodizzato
- 08 Bianco satinato

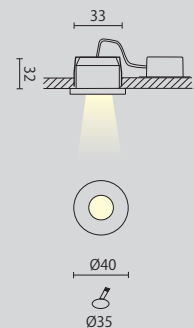

CODICE	W	Lm	€ (IVA esclusa) / (VAT excluded)
A5-656.30	3	150	48,00

\*cod. LE002-25

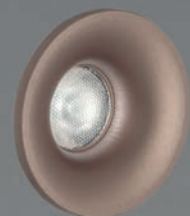

## AMBO-B

INCASSO / RECESSED

- 45° (a richiesta 25°)\*  
(25° on request)\*
- TC 3000K
- IP 40
- CRI >80
- EEI A+
- RG 1
- D Driver incluso  
Driver included

- 16 Bronzo anodizzato
- 08 Bianco satinato

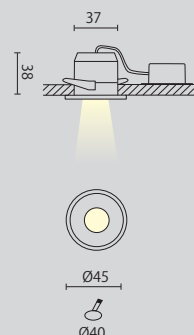

CODICE	W	Lm	€ (IVA esclusa) / (VAT excluded)
A5-655.30	3	150	48,00

\*cod. LE002-25



SISTEMI  
SYSTEMS

TIMBER

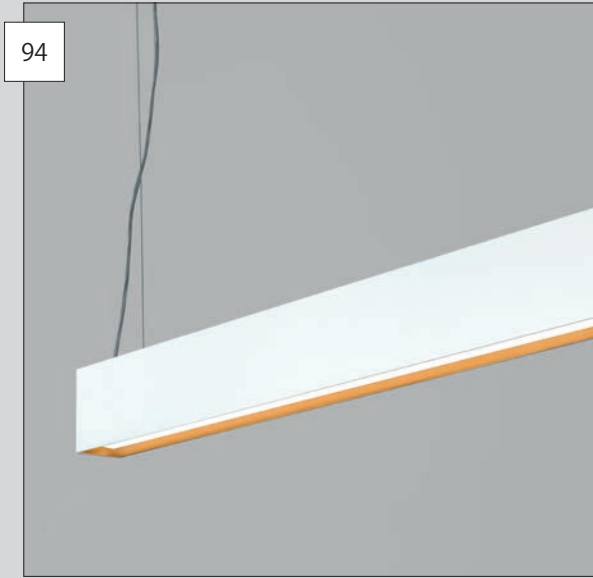

94

LINE INCASSO

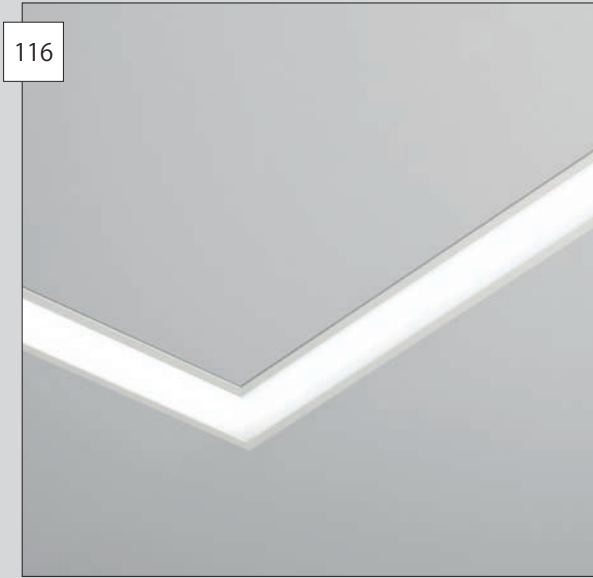

116

MINILINE



124

AT



128

ESPO'

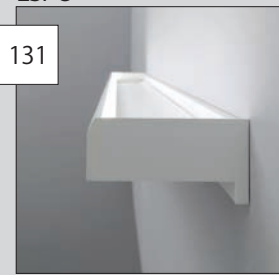

131

FUSION SOSPENSIONE

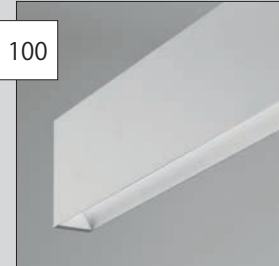

100

FUSION PLAFONE

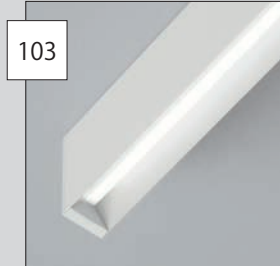

103

ESPO' 2

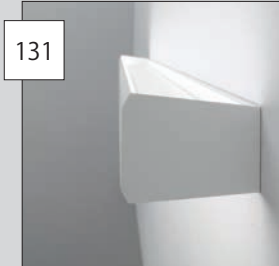

131

FROY



132

LATY



133

FUSION INCASSO



104

LINE SOSPENSIONE



112

LINE PLAFONE

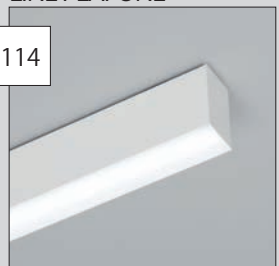

114

ASY



132





## TIMBER PRO LIGHT MONOEMISSIONE

SISTEMA SOSPENSIONE / HANGING SYSTEM

- 75°
- 3000K / 4000K
- IP 40
- CRI >80
- EEI A++
- RG 0
- Driver incluso / Driver included

- COLORE PROFILO / BODY COLOUR
- 02 Nero opaco
  - 08 Bianco satinato
  - 46 Rovere sbiancato
- COLORE INSERTO / COLOURED INSERT
- T002 Nero opaco
  - T008 Bianco satinato
  - T013 Oro
- A (esclusi) vedi p. 98 / (not included) see p. 98

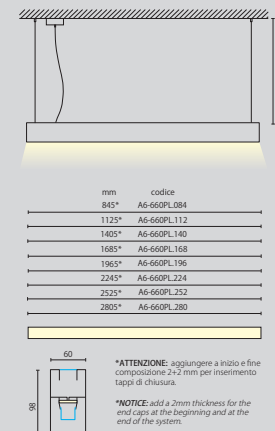

## TIMBER SOFT MONOEMISSIONE

SISTEMA SOSPENSIONE / HANGING SYSTEM

- 75°
- 3000K / 4000K
- IP 40
- CRI >80
- EEI A++
- RG 0
- Driver incluso / Driver included

- COLORE PROFILO / BODY COLOUR
- 02 Nero opaco
  - 08 Bianco satinato
  - 46 Rovere sbiancato
- COLORE INSERTO / COLOURED INSERT
- T002 Nero opaco
  - T008 Bianco satinato
  - T013 Oro
- A (esclusi) vedi p. 98 / (not included) see p. 98

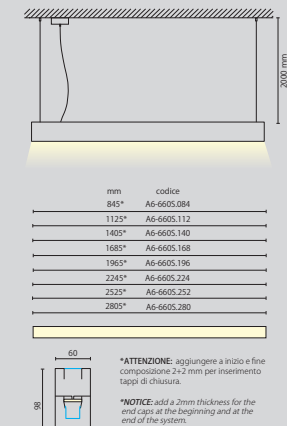

CODICE	W	Lm (3000K)	€ (IVA esclusa) / (VAT excluded) Colore 02-08 / Colour 02-08	../DIMM2-3 (Dimmerabile) Colore 02-08 / Colour 02-08	€ (IVA esclusa) / (VAT excluded) Colore 46 / Colour 46	../DIMM2-3 (Dimmerabile) Colore 46 / Colour 46	€ (IVA esclusa) / (VAT excluded) Inserti (coppia) / Inserts (pair)
A6-660PL.084...	27	3300	200,00	233,00	225,00	258,00	40,00
A6-660PL.112...	35	4400	239,00	272,00	274,00	307,00	40,00
A6-660PL.140...	44	5500	300,00	328,00	340,00	368,00	48,00
A6-660PL.168...	53	6600	343,00	375,00	398,00	430,00	48,00
A6-660PL.196...	62	7700	394,00	428,00	454,00	488,00	79,00
A6-660PL.224...	71	8800	433,00	471,00	503,00	541,00	79,00
A6-660PL.252...	80	9900	485,00	510,00	560,00	585,00	98,00
A6-660PL.280...	88	11000	552,00	618,00	637,00	703,00	98,00

.../EM (a richiesta) / (on request)

CODICE	W	Lm (3000K)	€ (IVA esclusa) / (VAT excluded) Colore 02-08 / Colour 02-08	../DIMM2-3 (Dimmerabile) Colore 02-08 / Colour 02-08	€ (IVA esclusa) / (VAT excluded) Colore 46 / Colour 46	../DIMM2-3 (Dimmerabile) Colore 46 / Colour 46	€ (IVA esclusa) / (VAT excluded) Inserti (coppia) / Inserts (pair)
A6-660S.084...	18	2430	188,00	-	211,00	-	40,00
A6-660S.112...	24	3250	225,00	256,00	258,00	289,00	40,00
A6-660S.140...	30	4060	282,00	308,00	320,00	346,00	48,00
A6-660S.168...	36	4870	322,00	352,00	374,00	404,00	48,00
A6-660S.196...	42	5680	370,00	402,00	427,00	459,00	79,00
A6-660S.224...	48	6500	407,00	443,00	473,00	509,00	79,00
A6-660S.252...	54	7310	456,00	480,00	526,00	550,00	98,00
A6-660S.280...	60	8120	519,00	581,00	600,00	661,00	98,00

.../EM (a richiesta) / (on request)



## TIMBER PRO LIGHT BIEMISSIONE

SISTEMA SOSPENSIONE / HANGING SYSTEM

- 75° / 100°
- 3000K / 4000K
- IP 40
- CRI >80
- EEI A++
- RG 0
- Driver incluso / Driver included

- COLORE PROFILO / BODY COLOUR
- 02 Nero opaco
  - 08 Bianco satinato
  - 46 Rovere sbiancato
- COLORE INSERTO / COLOURED INSERT
- T002 Nero opaco
  - T008 Bianco satinato
  - T013 Oro
- A (esclusi) vedi p. 98 / (not included) see p. 98

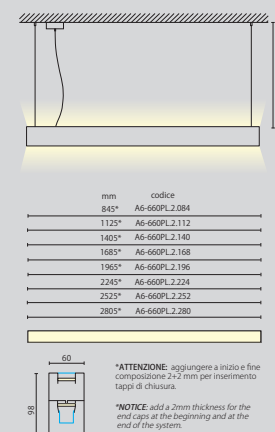

## TIMBER SOFT BIEMISSIONE

SISTEMA SOSPENSIONE / HANGING SYSTEM

- 75° / 100°
- 3000K / 4000K
- IP 40
- CRI >80
- EEI A++
- RG 0
- Driver incluso / Driver included

- COLORE PROFILO / BODY COLOUR
- 02 Nero opaco
  - 08 Bianco satinato
  - 46 Rovere sbiancato
- COLORE INSERTO / COLOURED INSERT
- T002 Nero opaco
  - T008 Bianco satinato
  - T013 Oro
- A (esclusi) vedi p. 98 / (not included) see p. 98

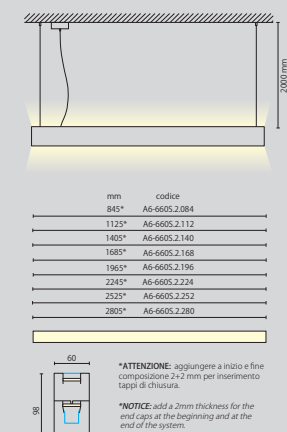

CODICE	W	Lm (3000K)	€ (IVA esclusa) / (VAT excluded) Colore 02-08 / Colour 02-08	../DIMM2-3 (Dimmerabile) Colore 02-08 / Colour 02-08	€ (IVA esclusa) / (VAT excluded) Colore 46 / Colour 46	../DIMM2-3 (Dimmerabile) Colore 46 / Colour 46	€ (IVA esclusa) / (VAT excluded) Inserti (coppia) / Inserts (pair)
A6-660PL.2.084...	2x27	2x3300	283,00	350,00	308,00	375,00	40,00
A6-660PL.2.112...	2x35	2x4400	340,00	400,00	370,00	430,00	40,00
A6-660PL.2.140...	2x44	2x5500	420,00	480,00	465,00	525,00	48,00
A6-660PL.2.168...	2x53	2x6600	497,00	550,00	547,00	600,00	48,00
A6-660PL.2.196...	2x62	2x7700	550,00	610,00	610,00	670,00	79,00
A6-660PL.2.224...	2x71	2x8800	600,00	667,00	670,00	737,00	79,00
A6-660PL.2.252...	2x80	2x9900	680,00	738,00	755,00	813,00	98,00
A6-660PL.2.280...	2x88	2x11000	766,00	867,00	850,00	951,00	98,00

doppia accensione / double switch

.../EM (a richiesta) / (on request)

CODICE	W	Lm (3000K)	€ (IVA esclusa) / (VAT excluded) Colore 02-08 / Colour 02-08	../DIMM2-3 (Dimmerabile) Colore 02-08 / Colour 02-08	€ (IVA esclusa) / (VAT excluded) Colore 46 / Colour 46	../DIMM2-3 (Dimmerabile) Colore 46 / Colour 46	€ (IVA esclusa) / (VAT excluded) Inserti (coppia) / Inserts (pair)
A6-660S.2.084...	2x18	2x2430	266,00	-	290,00	-	40,00
A6-660S.2.112...	2x24	2x3250	320,00	376,00	348,00	404,00	40,00
A6-660S.2.140...	2x30	2x4060	395,00	451,00	437,00	494,00	48,00
A6-660S.2.168...	2x36	2x4870	467,00	517,00	514,00	564,00	48,00
A6-660S.2.196...	2x42	2x5680	517,00	573,00	573,00	630,00	79,00
A6-660S.2.224...	2x48	2x6500	564,00	627,00	630,00	693,00	79,00
A6-660S.2.252...	2x54	2x7310	639,00	694,00	710,00	764,00	98,00
A6-660S.2.280...	2x60	2x8120	720,00	815,00	799,00	894,00	98,00

doppia accensione / double switch

.../EM (a richiesta) / (on request)

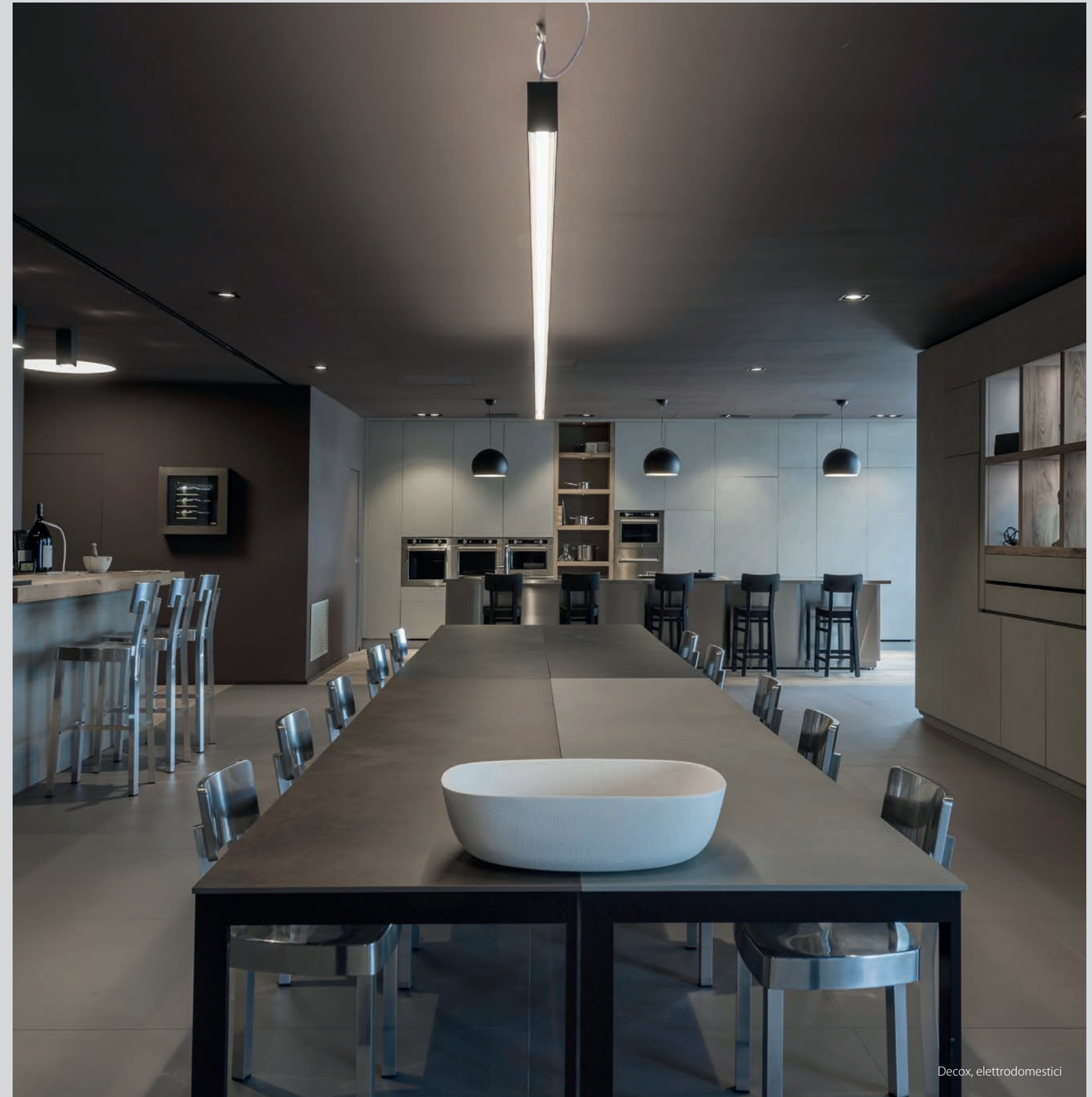
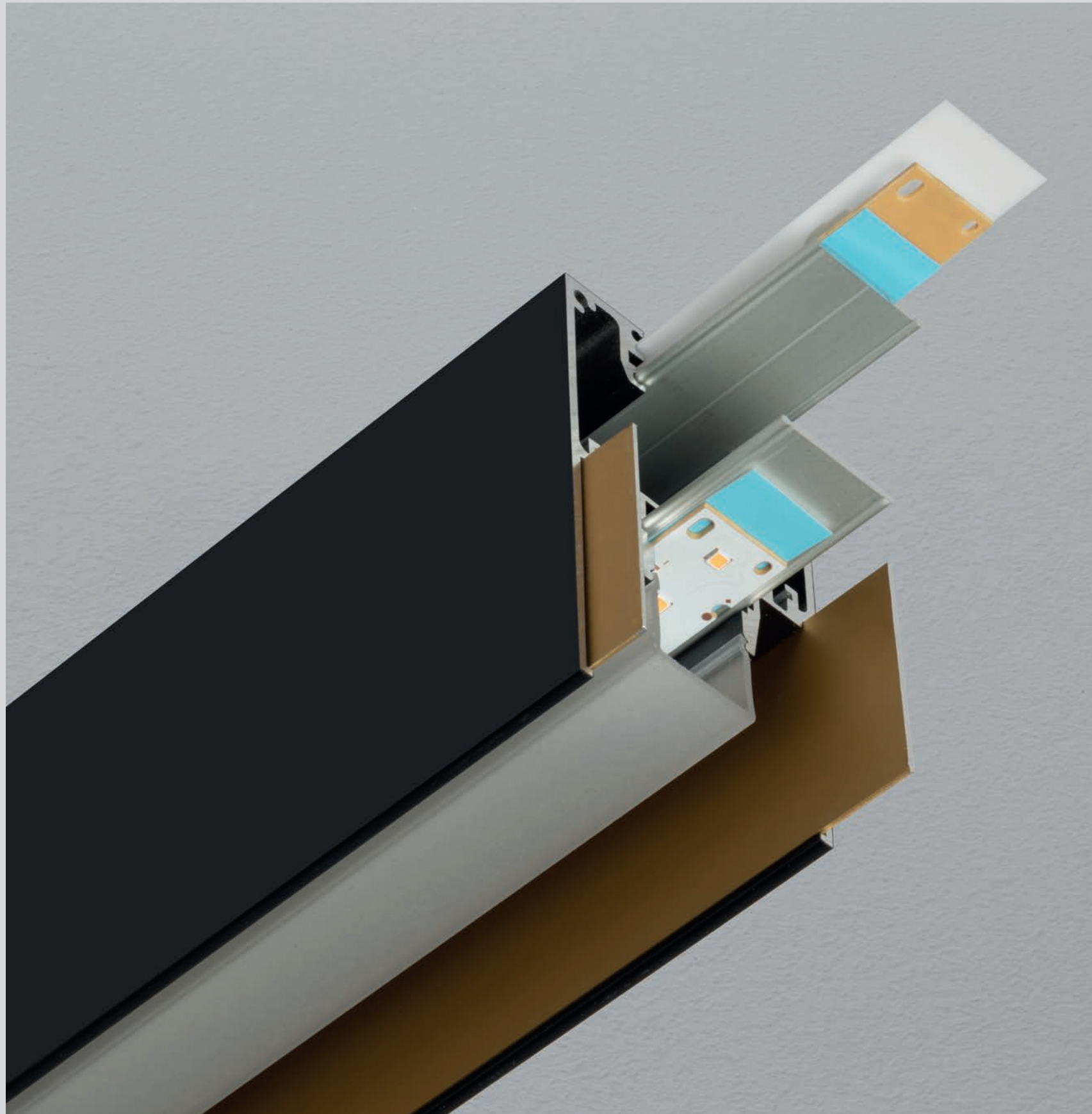

CODICE	DESCRIZIONE / DESCRIPTION	€ (IVA esclusa) / (VAT excluded)
A6-045	Terminali di chiusura (coppia). Colore 02-08-46. Colore inserti T002-T008-T013 <i>End caps (pair). Colour 02-08-46. Coloured insert T002-T008-T013</i>	72,00 (colore 02-08) / (colour 02-08) 92,00 (colore 46) / (colour 46)
A6-019.3	Rosone con cavo di alimentazione 3x0,75 mm <sup>2</sup> 200cm. Colore 02-08 <i>Ceiling cup with supply cable 3x0,75mm<sup>2</sup> 200 cm. Colour 02-08</i>	38,00
A6-019.4	Rosone con cavo di alimentazione 4x0,75 mm <sup>2</sup> 200cm per installazioni con doppia accensione. Colore 02-08 <i>Ceiling cup with supply cable 4x0,75mm<sup>2</sup> 200 cm, for double switch use. Colour 02-08</i>	42,00
A6-019.5	Rosone con cavo di alimentazione 5x0,75 mm <sup>2</sup> 200cm per installazioni dimmerabili o in emergenza. Colore 02-08 <i>Ceiling cup with supply cable 5x0,75mm<sup>2</sup> 200 cm, for dimming and emergency use. Colour 02-08</i>	52,00
A6-036	Cavi di sospensione 200cm. La frequenza dei cavi è consigliabile ogni metro <i>Suspension cables, 200 cm. Should be spaced one meter apart</i>	15,50
A6-047	Giunto lineare <i>In-line connector</i>	7,50
A6-048...	Curva 90° (vedere tabella). Colore 02-08-46. Colore inserti T002-T008-T013 <i>90° corner (see table). Colour 02-08-46. Coloured insert T002-T008-T013</i>	

CODICE	W	Lm (3000K)	€ (IVA esclusa) / (VAT excluded) Colore 02-08 / Colour 02-08	€ (IVA esclusa) / (VAT excluded) Colore 46 / Colour 46	€ (IVA esclusa) / (VAT excluded) n° 4 inserti / nr. 4 inserts
<b>MONOEMISSIONE / SINGLE EMISSION</b>					
A6-048PL.30 (Pro light)	35	4400	258,00	288,00	40,00
A6-048S.30 (Soft)	24	3250	242,00	271,00	40,00
<b>BIEMISSIONE / DOUBLE EMISSION</b>					
A6-048PL.2.30 (Pro light)	2x35	2x4400	357,00	392,00	40,00
A6-048S.2.30 (Soft)	2x24	2x3250	335,00	368,00	40,00

.40 per 4000K

/DIMM2-3 su richiesta / on request

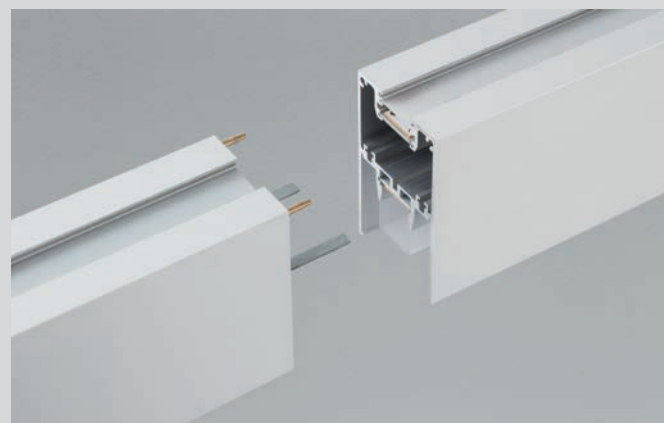
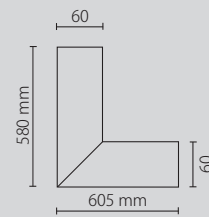

Giunto lineare / In-line connector



## FUSION PRO BIDIFFUSIONE

SISTEMA SOSPENSIONE / HANGING SYSTEM

$\downarrow$  70° (a richiesta 30°) / (30° on request)  
 $\uparrow$  120°

3000K / 4000K

40

>80

A++

0

Driver incluso  
Driver included

08 Bianco satinato  
 A (esclusi) vedi p. 110  
(not included) see p. 110

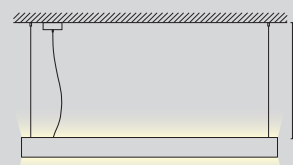

mm	codice
845*	A6-607.2.084
1125*	A6-607.2.112
1405*	A6-607.2.140
1685*	A6-607.2.168
1965*	A6-607.2.196
2245*	A6-607.2.224
2525*	A6-607.2.252
2805*	A6-607.2.280

**\*ATTENZIONE:** aggiungere a inizio e fine composizione 1,8 mm di spessore per i tappi di chiusura.  
Codifica: cod. prodotto/T=1 tappo  
cod. prodotto/TT=2 tappi  
**\*NOTICE:** add 1.8mm thickness for the end caps to the beginning and the end of the system.  
Product code/T=1 end cap  
Product code/TT=2 end caps

CODICE	W	Lm (3000K)	€ (IVA esclusa) / (VAT excluded)	... /DIMM2-3 (Dimmerabile)	... /EM (Emergenza)
A6-607.2.084...	2x30	2x3960	355,00	430,00	475,00
A6-607.2.112...	2x40	2x5280	426,00	498,00	566,00
A6-607.2.140...	2x50	2x6600	498,00	597,00	638,00
A6-607.2.168...	2x60	2x7920	610,00	680,00	750,00
A6-607.2.196...	2x70	2x9240	720,00	870,00	860,00
A6-607.2.224...	2x80	2x10560	797,00	980,00	937,00
A6-607.2.252...	2x90	2x11880	898,00	1040,00	1038,00
A6-607.2.280...	2x100	2x13200	990,00	1130,00	1130,00
LE001-30/100*	lente fascio 30° / 30° lens		15,00		

doppia accensione, \*codice e prezzo al metro / double switch, \*code and price per meter

## FUSION PRO LIGHT BIDIFFUSIONE

SISTEMA SOSPENSIONE / HANGING SYSTEM

$\downarrow$  70° (a richiesta 30°) / (30° on request)  
 $\uparrow$  120°

3000K / 4000K

40

>80

A++

0

Driver incluso  
Driver included

08 Bianco satinato  
 A (esclusi) vedi p. 110  
(not included) see p. 110

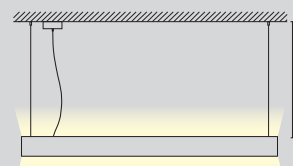

mm	codice
845*	A6-606.2.084
1125*	A6-606.2.112
1405*	A6-606.2.140
1685*	A6-606.2.168
1965*	A6-606.2.196
2245*	A6-606.2.224
2525*	A6-606.2.252
2805*	A6-606.2.280

**\*ATTENZIONE:** aggiungere a inizio e fine composizione 1,8 mm di spessore per i tappi di chiusura.  
Codifica: cod. prodotto/T=1 tappo  
cod. prodotto/TT=2 tappi  
**\*NOTICE:** add 1.8 mm thickness for the end caps to the beginning and the end of the system.  
Product code/T=1 end cap  
Product code/TT=2 end caps

CODICE	W	Lm (3000K)	€ (IVA esclusa) / (VAT excluded)	... /DIMM2-3 (Dimmerabile)	... /EM (Emergenza)
A6-606.2.084...	2x27	2x3300	263,00	323,00	403,00
A6-606.2.112...	2x35	2x4400	315,00	369,00	455,00
A6-606.2.140...	2x44	2x5500	384,00	443,00	524,00
A6-606.2.168...	2x53	2x6600	442,00	509,00	582,00
A6-606.2.196...	2x62	2x7700	495,00	556,00	635,00
A6-606.2.224...	2x71	2x8800	543,00	597,00	683,00
A6-606.2.252...	2x80	2x9900	612,00	673,00	752,00
A6-606.2.280...	2x88	2x11000	710,00	790,00	850,00
LE001-30/100*	lente fascio 30° / 30° lens		15,00		

doppia accensione, \*codice e prezzo al metro / double switch, \*code and price per meter



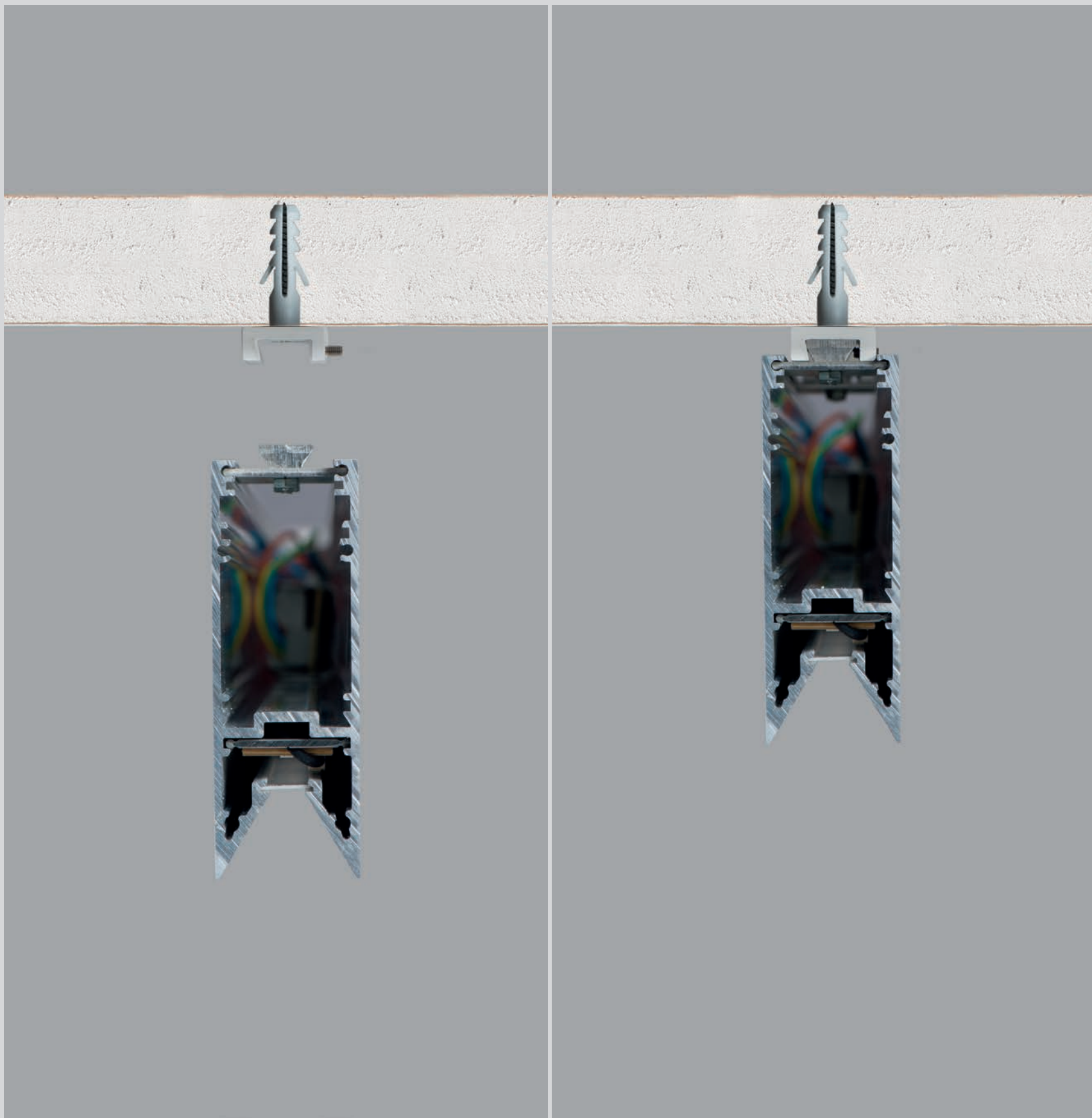

## FUSION PRO

SISTEMA PLAFONE / CEILING SYSTEM

- 70° (a richiesta 30°)  
(30° on request)
- 3000K / 4000K
- 40
- >80
- A++
- 0
- Driver incluso  
Driver included

**08** Bianco satinato  
(esclusi) vedi p. 110  
(not included) see p. 110

mm	codice
845*	A6-617.084
1125*	A6-617.112
1405*	A6-617.140
1685*	A6-617.168
1965*	A6-617.196
2245*	A6-617.224
2525*	A6-617.252
2805*	A6-617.280

**\*ATTENZIONE:** aggiungere a inizio e fine composizione 1,8 mm di spessore per i tappi di chiusura.  
Codifica: cod. prodotto/TT=1 tappo  
cod. prodotto/TT=2 tappi

**\*NOTICE:** add 1.8 mm thickness for the end caps to the beginning and the end of the system.  
Product code/TT=1 end cap  
Product code/TT=2 end caps

CODICE	W	Lm (3000K)	€ (IVA esclusa) / (VAT excluded)	... /DIMM2-3 (Dimmerabile)	... /EM (Emergenza)
A6-617.084...	30	3960	253,00	290,00	393,00
A6-617.112...	40	5280	292,00	337,00	432,00
A6-617.140...	50	6600	357,00	405,00	497,00
A6-617.168...	60	7920	424,00	445,00	564,00
A6-617.196...	70	9240	488,00	563,00	628,00
A6-617.224...	80	10560	533,00	607,00	673,00
A6-617.252...	90	11880	588,00	670,00	728,00
A6-617.280...	100	13200	646,00	725,00	786,00
LE001-30/100*	lente fascio 30° / 30° lens		15,00		

\*codice e prezzo al metro / \*code and price per meter



## FUSION PRO LIGHT

SISTEMA PLAFONE / CEILING SYSTEM

- 70° (a richiesta 30°)  
(30° on request)
- 3000K / 4000K
- 40
- >80
- A++
- 0
- Driver incluso  
Driver included

**08** Bianco satinato  
(esclusi) vedi p. 110  
(not included) see p. 110

mm	codice
845*	A6-616.084
1125*	A6-616.112
1405*	A6-616.140
1685*	A6-616.168
1965*	A6-616.196
2245*	A6-616.224
2525*	A6-616.252
2805*	A6-616.280







**\*ATTENZIONE:** aggiungere a inizio e fine composizione 1,8 mm di spessore per i tappi di chiusura.  
Codifica: cod. prodotto/TT=1 tappo  
cod. prodotto/TT=2 tappi



**\*NOTICE:** add 1.8mm thickness for the end caps to the beginning and the end of the system.  
Product code/TT=1 end cap  
Product code/TT=2 end caps

CODICE	W	Lm (3000K)	€ (IVA esclusa) / (VAT excluded)	... /DIMM2-3 (Dimmerabile)	... /EM (Emergenza)
A6-616.084...	27	3300	211,00	244,00	351,00
A6-616.112...	35	4400	244,00	276,00	384,00
A6-616.140...	44	5500	295,00	334,00	435,00
A6-616.168...	53	6600	330,00	361,00	470,00
A6-616.196...	62	7700	372,00	409,00	512,00
A6-616.224...	71	8800	410,00	425,00	550,00
A6-616.252...	80	9900	450,00	470,00	590,00
A6-616.280...	88	11000	499,00	560,00	639,00
LE001-30/100*	lente fascio 30° / 30° lens		15,00		

\*codice e prezzo al metro / \*code and price per meter

**FUSION 24**  
SISTEMA INCASSO SENZA BORDO  
TRIMLESS RECESSED SYSTEM

-  70° (a richiesta 30°)  
(30° on request)
-  3000K / 4000K
-  40
-  >80
-  A++
-  0
-  Driver 24Vdc escluso (p. 149)  
24Vdc driver not included (p. 149)

 Bianco satinato  
 (esclusi) vedi p. 111  
(not included) see p. 111

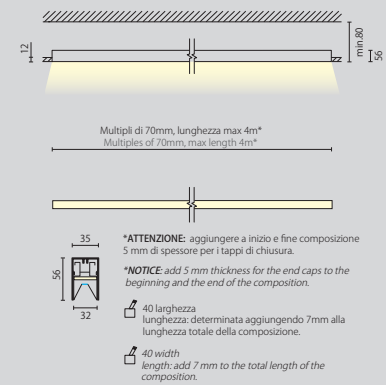

CODICE	W	Lm (3000K)	€ (IVA esclusa) / (VAT excluded)
A6-639.100...*	31	3000	162,00
LE001-30/100*	lente fascio 30° / 30° lens		15,00





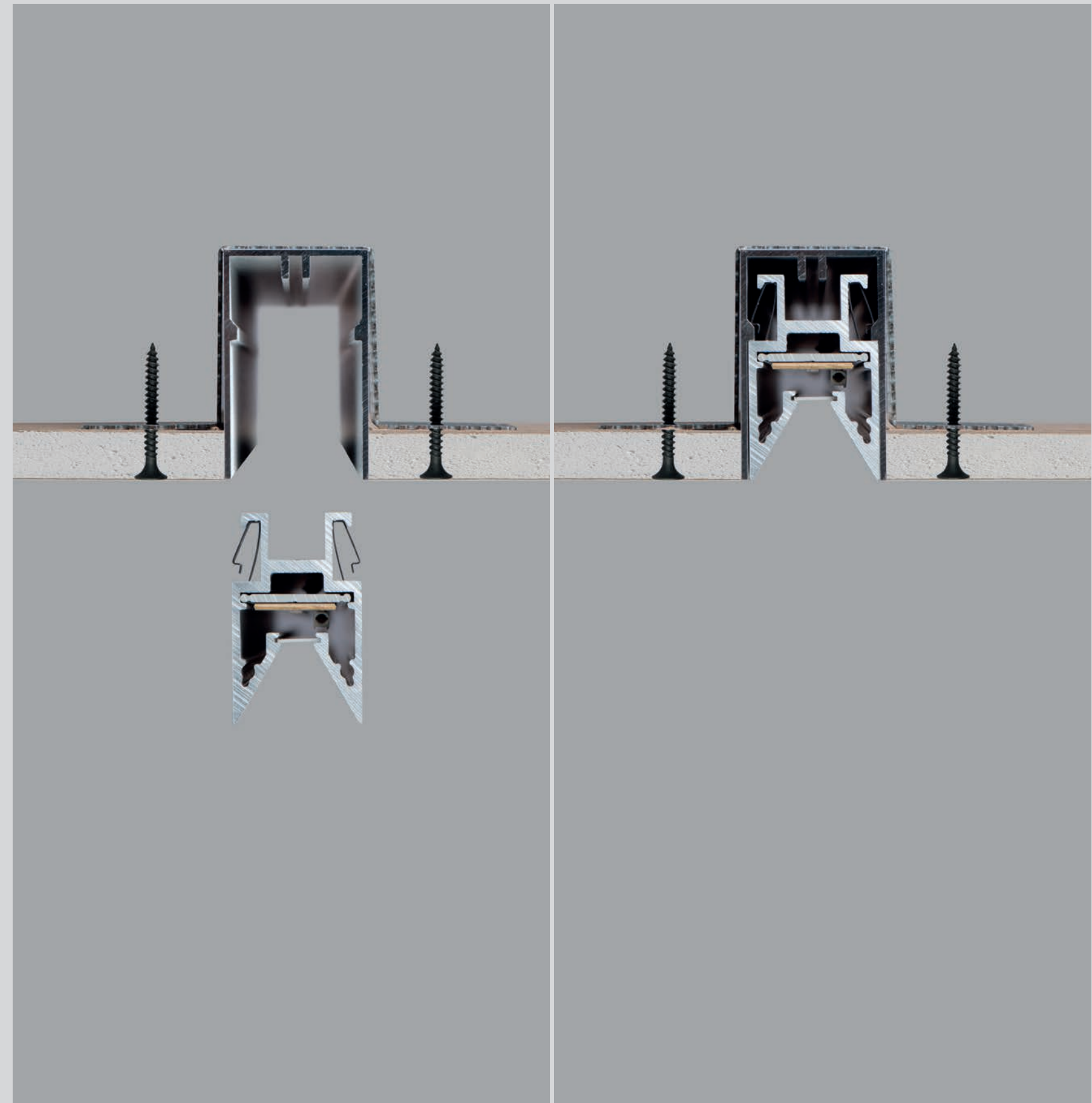
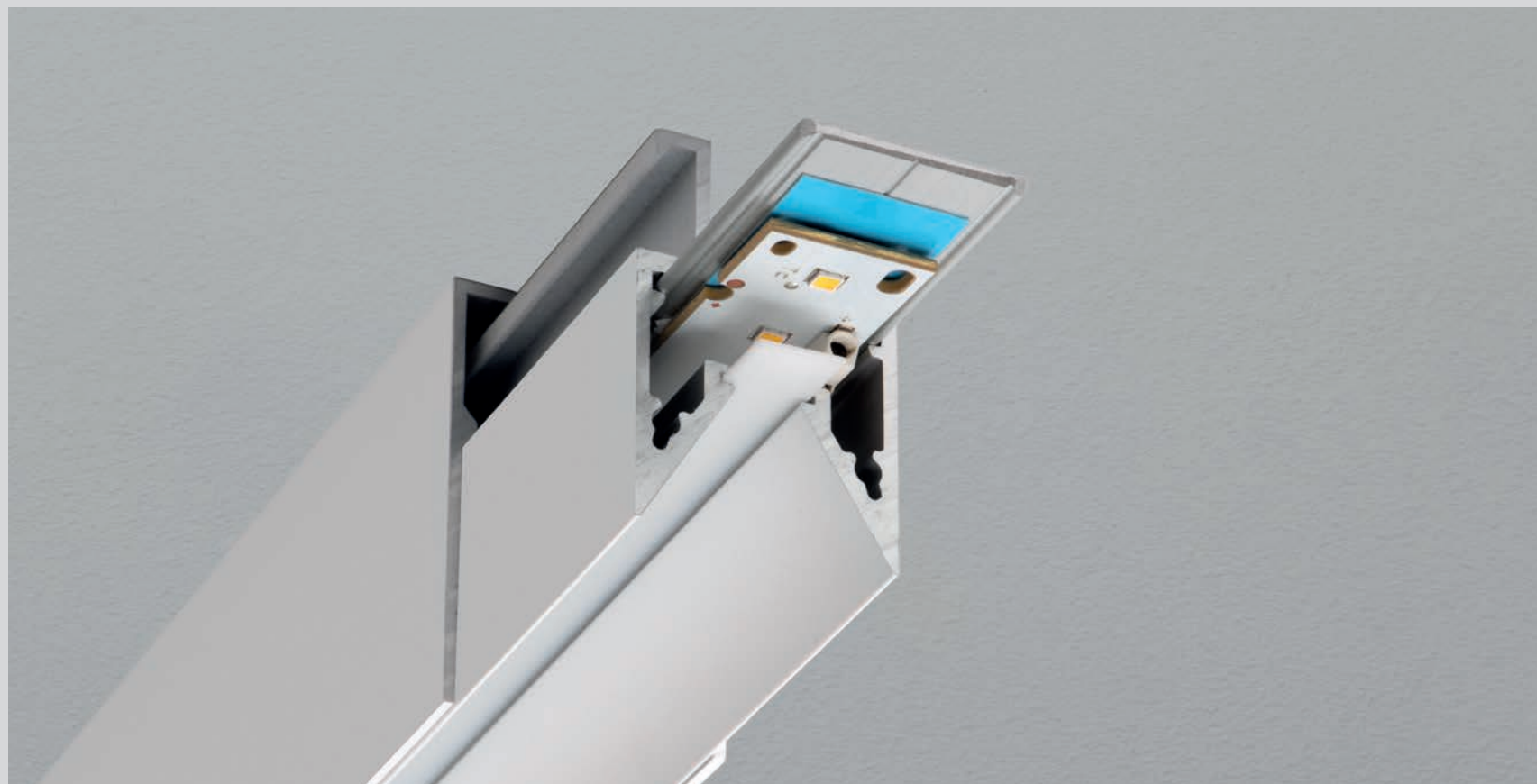

controcassa inclusa / flush box included



\*codice e prezzo al metro / \*code and price per meter





**FUSION** PRO LIGHT  
SISTEMA INCASSO CON BORDO  
RECESSED SYSTEM WITH TRIM

-  70° (a richiesta 30°)  
(30° on request)
-  TC 3000K / 4000K
-  IP 40
-  CRI >80
-  EEI A++
-  RG 0
-  D Driver incluso  
Driver included

 08 Bianco satinato  
 A (esclusi) vedi p. 111  
(not included) see p. 111

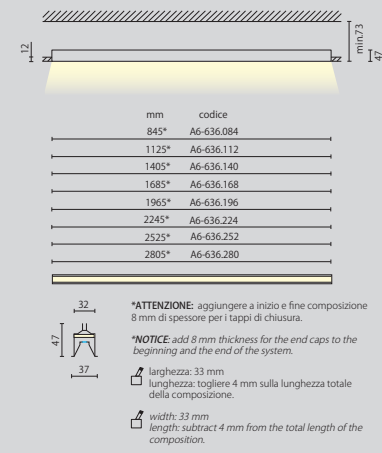

CODICE	W	Lm (3000K)	€ (IVA esclusa) / (VAT excluded)	.../DIMM2-3 (Dimmerabile)	.../EM (Emergenza)
A6-636.084...	27	3300	180,00	219,00	320,00
A6-636.112...	35	4400	200,00	242,00	340,00
A6-636.140...	44	5500	250,00	280,00	390,00
A6-636.168...	53	6600	285,00	325,00	425,00
A6-636.196...	62	7700	317,00	350,00	457,00
A6-636.224...	71	8800	340,00	377,00	480,00
A6-636.252...	80	9900	390,00	424,00	530,00
A6-636.280...	88	11000	430,00	500,00	570,00
LE001-30/100*	lente fascio 30° / 30° lens		15,00		

\*codice e prezzo al metro / \*code and price per meter

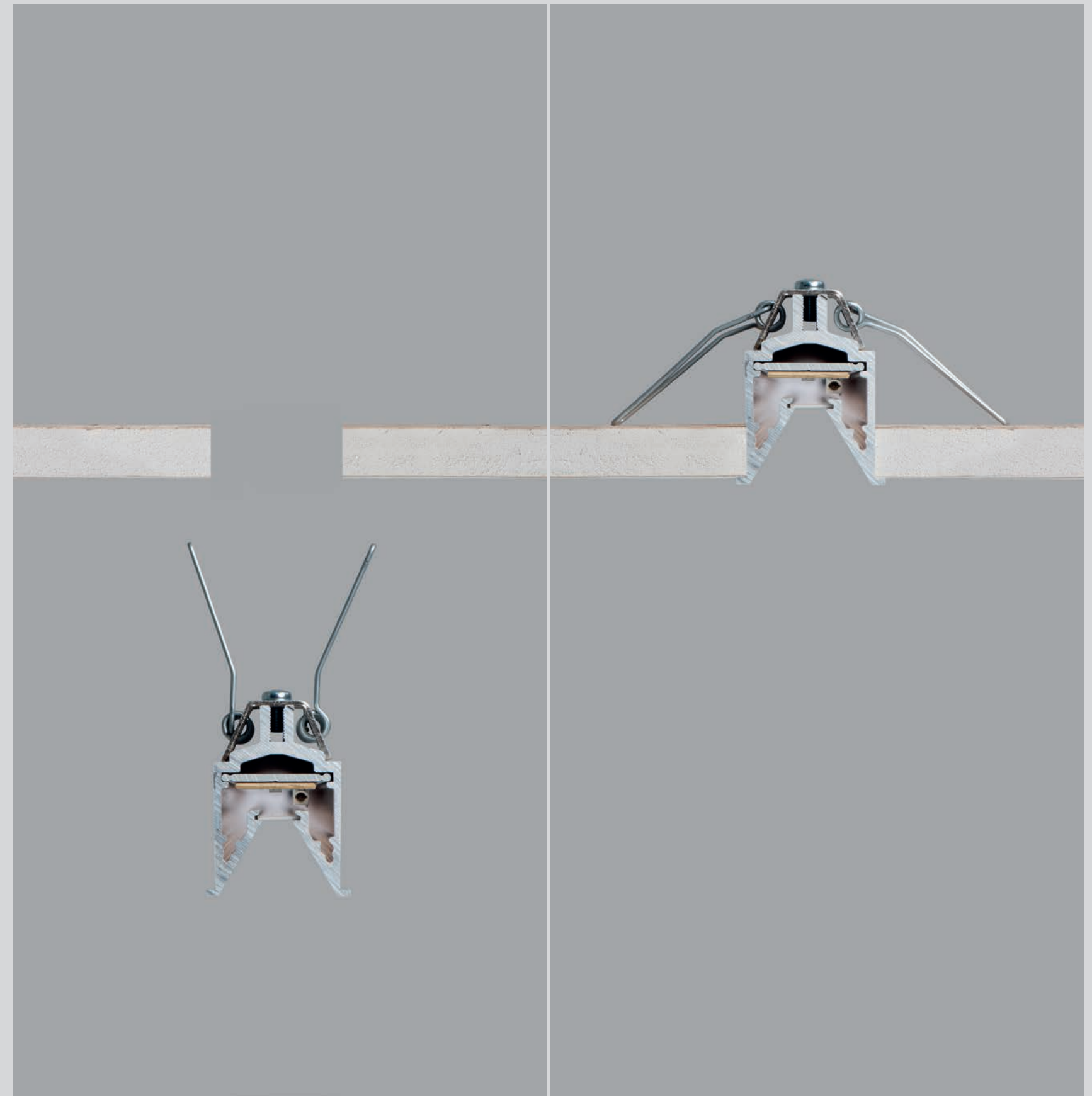
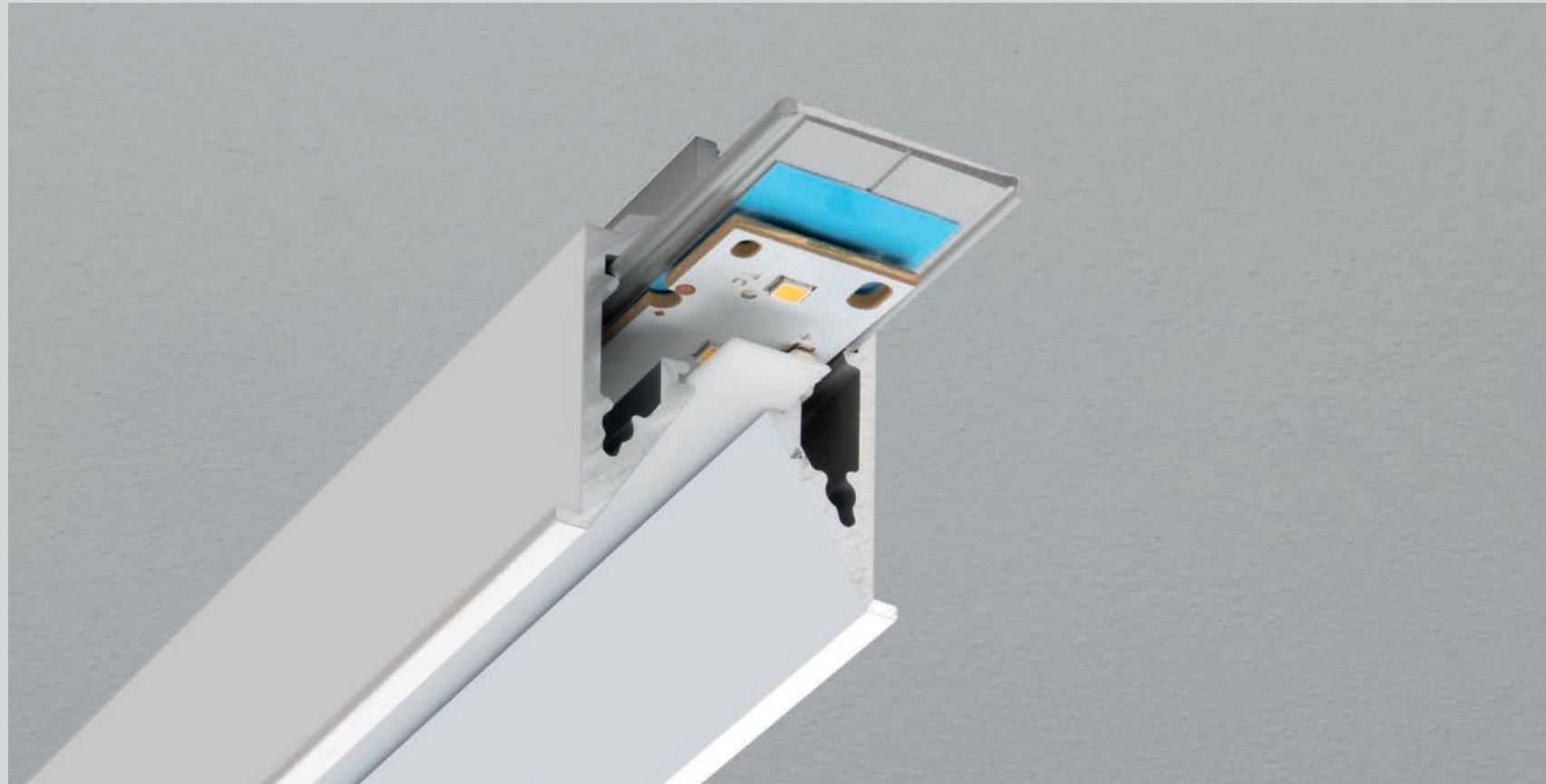



CODICE	DESCRIZIONE / DESCRIPTION	€ (IVA esclusa) / (VAT excluded)
A6-019.3	Rosone con cavo di alimentazione 3x0,75 mm <sup>2</sup> 200 cm / <i>Ceiling cup with supply cable 3x0,75mm<sup>2</sup> 200 cm</i>	38,00
A6-019.4	Rosone con cavo di alimentazione 4x0,75 mm <sup>2</sup> 200 cm, per installazioni con doppia accensione <i>Ceiling cup with supply cable 4x0,75mm<sup>2</sup> 200 cm, for double switch use</i>	42,00
A6-019.5	Rosone con cavo di alimentazione 5x0,75 mm <sup>2</sup> 200 cm, per installazioni dimmerabili o in emergenza <i>Ceiling cup with supply cable 5x0,75mm<sup>2</sup> 200 cm, for dimming and emergency use</i>	52,00
A6-036	Cavi di sospensione 200 cm / <i>Suspension cables, 200 cm</i>	15,50
A6-037	Giunto lineare / <i>In-line connector</i>	4,30
X	Prolungamento + 32 mm per curva 90° (vedi p.157) / <i>Extension + 32 mm for a 90° corner (see p. 157)</i>	25,00
Y	Prolungamento + 32 mm per curva 90° (vedi p.157) / <i>Extension + 32 mm for a 90° corner (see p. 157)</i>	25,00
Z	Prolungamento + 32 mm per curva 90° (vedi p.157) / <i>Extension + 32 mm for a 90° corner (see p. 157)</i>	50,00
K	Prolungamento + 32 mm per curva 90° (vedi p.157) / <i>Extension + 32 mm for a 90° corner (see p. 157)</i>	50,00
W	Prolungamento + 32 mm per curva 90° (vedi p.157) / <i>Extension + 32 mm for a 90° corner (see p. 157)</i>	50,00
T	Tappo d'inizio o fine sistema (singolo) / <i>End cap (single)</i>	15,00
TT	Tappi per unico modulo (coppia) / <i>End caps for one single section (pair)</i>	30,00
LE001-30/100*	Lente con fascio 30° (codice e prezzo al metro) / <i>30° lens (code per meter)</i>	15,00

altre tipologie di curva su richiesta / *customized corners on request*

CODICE	DESCRIZIONE / DESCRIPTION	€ (IVA esclusa) / (VAT excluded)
A6-037	Giunto lineare / <i>In-line connector</i>	4,30
A6-039	Terminali di chiusura (coppia) / <i>End caps (pair)</i>	30,00
A6-040	Terminali di chiusura per cassaforma (coppia) / <i>End caps for flush box (pair)</i>	10,00
X	Prolungamento + 32 mm per curva 90° (vedi p.157) / <i>Extension + 32 mm for a 90° corner (see p. 157)</i>	25,00
Y	Prolungamento + 32 mm per curva 90° (vedi p.157) / <i>Extension + 32 mm for a 90° corner (see p. 157)</i>	25,00
Z	Prolungamento + 32 mm per curva 90° (vedi p.157) / <i>Extension + 32 mm for a 90° corner (see p. 157)</i>	50,00
K	Prolungamento + 32 mm per curva 90° (vedi p.157) / <i>Extension + 32 mm for a 90° corner (see p. 157)</i>	50,00
W	Prolungamento + 32 mm per curva 90° (vedi p.157) / <i>Extension + 32 mm for a 90° corner (see p. 157)</i>	50,00
LE001-30/100*	Lente con fascio 30° (codice e prezzo al metro) / <i>30° lens (code per meter)</i>	15,00
0800/DIM	Dispositivo di dimmerazione (DIMMER) / <i>Dimming kit</i>	88,00
0800/EM	Kit di emergenza con pacco batterie / <i>Emergency kit with batteries</i>	125,00

altre tipologie di curva su richiesta / *customized corners on request*

CODICE	DESCRIZIONE / DESCRIPTION	€ (IVA esclusa) / (VAT excluded)
A6-037	Giunto lineare / <i>In-line connector</i>	4,30
X	Prolungamento + 32 mm per curva 90° (vedi p.157) / <i>Extension + 32 mm for a 90° corner (see p. 157)</i>	25,00
Y	Prolungamento + 32 mm per curva 90° (vedi p.157) / <i>Extension + 32 mm for a 90° corner (see p. 157)</i>	25,00
Z	Prolungamento + 32 mm per curva 90° (vedi p.157) / <i>Extension + 32 mm for a 90° corner (see p. 157)</i>	50,00
K	Prolungamento + 32 mm per curva 90° (vedi p.157) / <i>Extension + 32 mm for a 90° corner (see p. 157)</i>	50,00
W	Prolungamento + 32 mm per curva 90° (vedi p.157) / <i>Extension + 32 mm for a 90° corner (see p. 157)</i>	50,00
T	Tappo d'inizio o fine sistema (singolo) / <i>End cap (single)</i>	15,00
TT	Tappi per unico modulo (coppia) / <i>End caps for one single section (pair)</i>	30,00
LE001-30/100*	Lente con fascio 30° (codice e prezzo al metro) / <i>30° lens (code per meter)</i>	15,00

altre tipologie di curva su richiesta / *customized corners on request*

CODICE	DESCRIZIONE / DESCRIPTION	€ (IVA esclusa) / (VAT excluded)
A6-037	Giunto lineare / <i>In-line connector</i>	4,30
A6-038	Terminali di chiusura (coppia) / <i>End caps (pair)</i>	30,00
X	Prolungamento + 37 mm per curva 90° (vedi p.157) / <i>Extension + 37 mm for a 90° corner (see p. 157)</i>	25,00
Y	Prolungamento + 37 mm per curva 90° (vedi p.157) / <i>Extension + 37 mm for a 90° corner (see p. 157)</i>	25,00
Z	Prolungamento + 37 mm per curva 90° (vedi p.157) / <i>Extension + 37 mm for a 90° corner (see p. 157)</i>	50,00
K	Prolungamento + 37 mm per curva 90° (vedi p.157) / <i>Extension + 37 mm for a 90° corner (see p. 157)</i>	50,00
W	Prolungamento + 37 mm per curva 90° (vedi p.157) / <i>Extension + 37 mm for a 90° corner (see p. 157)</i>	50,00
LE001-30/100*	Lente con fascio 30° (codice e prezzo al metro) / <i>30° lens (code per meter)</i>	15,00

altre tipologie di curva su richiesta / *customized corners on request*



\*LENTE FASCIO 30° / 30° LENS

Lente di fascio 30° che, riducendo la luminanza diretta dell'apparecchio, rende Fusion adatto all'installazione in ambienti in cui viene richiesto un UGR<19 (normativa UNI-11165 e UNI 12464-1), quali uffici o postazioni con videotermini.

*The 30° lens reducing the luminaire's direct lighting permits Fusion to be used in spaces requiring an excellent visual comfort (UGR<19, standards UNI-11165 and EN 12464-1), like offices and workstations with video terminals.*

## LINE PRO

SISTEMA SOSPENSIONE / HANGING SYSTEM

- 105°
- 3000K / 4000K
- 40
- >80
- A++
- 0
- Driver incluso  
Driver included

- Nero opaco
- Bianco opaco
- (esclusi) vedi p. 122  
(not included) see p. 122

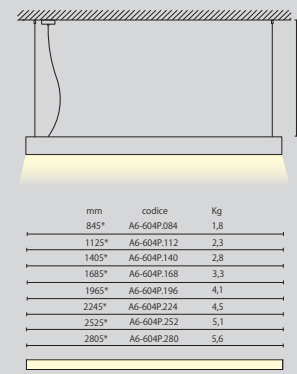

mm	codice	Kg
845*	A6-604P.084	1,8
1125*	A6-604P.112	2,3
1405*	A6-604P.140	2,8
1685*	A6-604P.168	3,3
1965*	A6-604P.196	4,1
2245*	A6-604P.224	4,5
2525*	A6-604P.252	5,1
2805*	A6-604P.280	5,6

**\*ATTENZIONE:** aggiungere ad inizio e fine sistema 2,5 mm di spessore per i tappi di chiusura.  
**NOTICE:** add a 2,5 mm thickness for the end caps to the beginning and the end of the system.

CODICE	W	Lm (3000K)	€ (IVA esclusa) / (VAT excluded)	... /DIMM2-3 (Dimmerabile)	... /EM (Emergenza)
A6-604P.084...	36	4500	220,00	260,00	360,00
A6-604P.112...	48	6000	269,00	320,00	409,00
A6-604P.140...	60	7500	325,00	376,00	465,00
A6-604P.168...	72	9000	397,00	420,00	537,00
A6-604P.196...	84	10500	460,00	550,00	600,00
A6-604P.224...	96	12000	507,00	590,00	647,00
A6-604P.252...	108	13500	563,00	660,00	703,00
A6-604P.280...	120	15000	638,00	710,00	778,00
A6-015/100* diffusore in polimetilmetacrilato microprismato / micro-prismatic polymethyl methacrylate screen			10,00		

\*codice e prezzo al metro / \*code and price per meter

## LINE SOFT

SISTEMA SOSPENSIONE / HANGING SYSTEM

- 105°
- 3000K / 4000K
- 40
- >80
- A++
- 0
- Driver incluso  
Driver included

- Nero opaco
- Bianco opaco
- (esclusi) vedi p. 122  
(not included) see p. 122

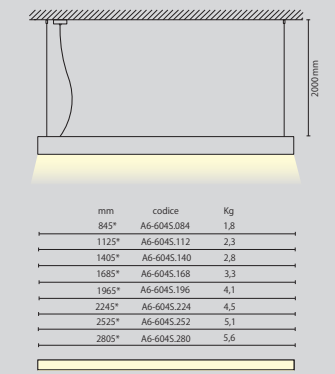

mm	codice	Kg
845*	A6-604S.084	1,8
1125*	A6-604S.112	2,3
1405*	A6-604S.140	2,8
1685*	A6-604S.168	3,3
1965*	A6-604S.196	4,1
2245*	A6-604S.224	4,5
2525*	A6-604S.252	5,1
2805*	A6-604S.280	5,6

**\*ATTENZIONE:** aggiungere ad inizio e fine sistema 2,5 mm di spessore per i tappi di chiusura.  
**NOTICE:** add a 2,5 mm thickness for the end caps to the beginning and the end of the system.

CODICE	W	Lm (3000K)	€ (IVA esclusa) / (VAT excluded)	... /DIMM2-3 (Dimmerabile)	... /EM (Emergenza)
A6-604S.084...	18	2430	164,00	-	304,00
A6-604S.112...	24	3250	200,00	228,00	340,00
A6-604S.140...	30	4060	243,00	268,00	383,00
A6-604S.168...	36	4870	272,00	306,00	412,00
A6-604S.196...	42	5680	320,00	345,00	460,00
A6-604S.224...	48	6500	353,00	380,00	493,00
A6-604S.252...	54	7310	393,00	420,00	533,00
A6-604S.280...	60	8120	443,00	516,00	583,00
A6-015/100* diffusore in polimetilmetacrilato microprismato / micro-prismatic polymethyl methacrylate screen			10,00		

\*codice e prezzo al metro / \*code and price per meter

## LINE PRO LIGHT

SISTEMA SOSPENSIONE / HANGING SYSTEM

- 105°
- 3000K / 4000K
- 40
- >80
- A++
- 0
- Driver incluso  
Driver included

- Nero opaco
- Bianco opaco
- (esclusi) vedi p. 122  
(not included) see p. 122

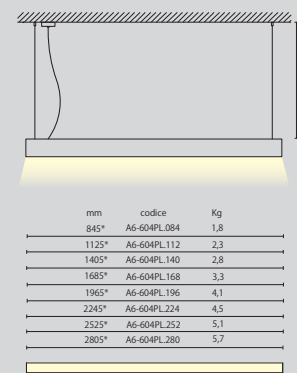

mm	codice	Kg
845*	A6-604PL.084	1,8
1125*	A6-604PL.112	2,3
1405*	A6-604PL.140	2,8
1685*	A6-604PL.168	3,3
1965*	A6-604PL.196	4,1
2245*	A6-604PL.224	4,5
2525*	A6-604PL.252	5,1
2805*	A6-604PL.280	5,7







**\*ATTENZIONE:** aggiungere ad inizio e fine sistema 2,5 mm di spessore per i tappi di chiusura.  
**NOTICE:** add a 2,5 mm thickness for the end caps to the beginning and the end of the system.



CODICE	W	Lm (3000K)	€ (IVA esclusa) / (VAT excluded)	... /DIMM2-3 (Dimmerabile)	... /EM (Emergenza)
A6-604PL.084...	27	3300	180,00	220,00	320,00
A6-604PL.112...	35	4400	220,00	250,00	360,00
A6-604PL.140...	44	5500	265,00	293,00	405,00
A6-604PL.168...	53	6600	298,00	335,00	438,00
A6-604PL.196...	62	7700	350,00	378,00	490,00
A6-604PL.224...	71	8800	386,00	415,00	526,00
A6-604PL.252...	80	9900	430,00	460,00	570,00
A6-604PL.280...	88	11000	485,00	565,00	625,00
A6-015/100* diffusore in polimetilmetacrilato microprismato / micro-prismatic polymethyl methacrylate screen			10,00		

\*codice e prezzo al metro / \*code and price per meter



## LINE PRO SISTEMA PLAFONE / CEILING SYSTEM

-  105°
-  3000K / 4000K
-  IP 40
-  >80
-  EEI A++
-  0
-  Driver incluso  
Driver included

-  02 Nero opaco
-  09 Bianco opaco
-  A (esclusi) vedi p. 122  
(not included) see p. 122

mm	codice	Kg
845*	A6-614P.084	1,8
1125*	A6-614P.112	2,3
1405*	A6-614P.140	2,8
1685*	A6-614P.168	3,3
1965*	A6-614P.196	4,1
2245*	A6-614P.224	4,5
2525*	A6-614P.252	5,1
2805*	A6-614P.280	5,6



**\*ATTENZIONE:** aggiungere ad inizio e fine sistema 2,5 mm di spessore per i tappi di chiusura.

**\*NOTICE:** add a 2.5 mm thickness for the end caps to the beginning and the end of the system.







CODICE	W	Lm (3000K)	€ (IVA esclusa) / (VAT excluded)	... /DIMM2-3 (Dimmerabile)	... /EM (Emergenza)
A6-614P.084...	36	4500	230,00	278,00	370,00
A6-614P.112...	48	6000	274,00	330,00	414,00
A6-614P.140...	60	7500	337,00	388,00	477,00
A6-614P.168...	72	9000	409,00	432,00	549,00
A6-614P.196...	84	10500	478,00	560,00	618,00
A6-614P.224...	96	12000	524,00	605,00	664,00
A6-614P.252...	108	13500	580,00	670,00	720,00
A6-614P.280...	120	15000	658,00	727,00	798,00
A6-015/100* diffusore in polimetilmetacrilato microprismato / micro-prismatic polymethyl methacrylate screen			10,00		



\*codice e prezzo al metro / \*code and price per meter



Basis Engineering, Assago

## LINE PRO LIGHT SISTEMA PLAFONE / CEILING SYSTEM

-  105°
-  3000K / 4000K
-  IP 40
-  >80
-  EEI A++
-  0
-  Driver incluso  
Driver included

-  02 Nero opaco
-  09 Bianco opaco
-  A (esclusi) vedi p. 122  
(not included) see p. 122

mm	codice	Kg
845*	A6-614PL.084	1,8
1125*	A6-614PL.112	2,3
1405*	A6-614PL.140	2,8
1685*	A6-614PL.168	3,3
1965*	A6-614PL.196	4,1
2245*	A6-614PL.224	4,5
2525*	A6-614PL.252	5,1
2805*	A6-614PL.280	5,6









**\*ATTENZIONE:** aggiungere ad inizio e fine sistema 2,5 mm di spessore per i tappi di chiusura.



**\*NOTICE:** add a 2.5 mm thickness for the end caps to the beginning and the end of the system.

CODICE	W	Lm (3000K)	€ (IVA esclusa) / (VAT excluded)	... /DIMM2-3 (Dimmerabile)	... /EM (Emergenza)
A6-614PL.084...	27	3300	191,00	228,00	331,00
A6-614PL.112...	35	4400	228,00	260,00	368,00
A6-614PL.140...	44	5500	276,00	308,00	416,00
A6-614PL.168...	53	6600	313,00	348,00	453,00
A6-614PL.196...	62	7700	365,00	398,00	505,00
A6-614PL.224...	71	8800	410,00	436,00	550,00
A6-614PL.252...	80	9900	450,00	484,00	600,00
A6-614PL.280...	88	11000	513,00	578,00	653,00
A6-015/100* diffusore in polimetilmetacrilato microprismato / micro-prismatic polymethyl methacrylate screen			10,00		

\*codice e prezzo al metro / \*code and price per meter

## LINE SOFT SISTEMA PLAFONE / CEILING SYSTEM

-  105°
-  3000K / 4000K
-  IP 40
-  >80
-  EEI A++
-  0
-  Driver incluso  
Driver included

-  02 Nero opaco
-  09 Bianco opaco
-  A (esclusi) vedi p. 122  
(not included) see p. 122

mm	codice	Kg
845*	A6-614S.084	1,8
1125*	A6-614S.112	2,3
1405*	A6-614S.140	2,8
1685*	A6-614S.168	3,3
1965*	A6-614S.196	4,1
2245*	A6-614S.224	4,5
2525*	A6-614S.252	5,1
2805*	A6-614S.280	5,6



**\*ATTENZIONE:** aggiungere ad inizio e fine sistema 2,5 mm di spessore per i tappi di chiusura.

**\*NOTICE:** add a 2.5 mm thickness for the end caps to the beginning and the end of the system.

CODICE	W	Lm (3000K)	€ (IVA esclusa) / (VAT excluded)	... /DIMM2-3 (Dimmerabile)	... /EM (Emergenza)
A6-614S.084...	18	2430	174,00	-	314,00
A6-614S.112...	24	3250	209,00	237,00	349,00
A6-614S.140...	30	4060	252,00	281,00	392,00
A6-614S.168...	36	4870	286,00	318,00	426,00
A6-614S.196...	42	5680	334,00	364,00	474,00
A6-614S.224...	48	6500	373,00	398,00	513,00
A6-614S.252...	54	7310	410,00	442,00	550,00
A6-614S.280...	60	8120	469,00	528,00	609,00
A6-015/100* diffusore in polimetilmetacrilato microprismato / micro-prismatic polymethyl methacrylate screen			10,00		

\*codice e prezzo al metro / \*code and price per meter

## LINE PRO

SISTEMA INCASSO CON BORDO  
RECESSED SYSTEM WITH TRIM

- 105°
- 3000K / 4000K
- IP 40
- CRI >80
- EEI A++
- RG 0
- Driver incluso  
Driver included

09 Bianco opaco  
A (esclusi) vedi p. 123  
(not included) see p. 123

mm	codice	Kg
845*	A6-624P.084	1,8
1125*	A6-624P.112	2,3
1405*	A6-624P.140	2,8
1685*	A6-624P.168	3,3
1965*	A6-624P.196	4,1
2245*	A6-624P.224	4,5
2525*	A6-624P.252	5,1
2805*	A6-624P.280	5,6

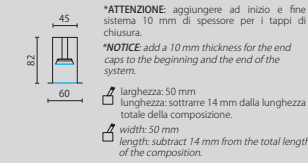

CODICE	W	Lm (3000K)	€ (IVA esclusa) / (VAT excluded)	... /DIMM2-3 (Dimmerabile)	... /EM (Emergenza)
A6-624P.084...	36	4500	251,00	286,00	391,00
A6-624P.112...	48	6000	290,00	339,00	430,00
A6-624P.140...	60	7500	350,00	399,00	490,00
A6-624P.168...	72	9000	422,00	445,00	562,00
A6-624P.196...	84	10500	490,00	572,00	630,00
A6-624P.224...	96	12000	532,00	610,00	672,00
A6-624P.252...	108	13500	595,00	685,00	735,00
A6-624P.280...	120	15000	670,00	740,00	810,00
A6-015/100* diffusore in polimetilmetacrilato microprismato / micro-prismatic polymethyl methacrylate screen			10,00		

\*codice e prezzo al metro / \*code and price per meter

## LINE SOFT

SISTEMA INCASSO CON BORDO  
RECESSED SYSTEM WITH TRIM

- 105°
- 3000K / 4000K
- IP 40
- CRI >80
- EEI A++
- RG 0
- Driver incluso  
Driver included

09 Bianco opaco  
A (esclusi) vedi p. 123  
(not included) see p. 123

mm	codice	Kg
845*	A6-624S.084	1,8
1125*	A6-624S.112	2,3
1405*	A6-624S.140	2,8
1685*	A6-624S.168	3,3
1965*	A6-624S.196	4,1
2245*	A6-624S.224	4,5
2525*	A6-624S.252	5,1
2805*	A6-624S.280	5,6

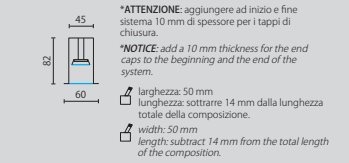

CODICE	W	Lm (3000K)	€ (IVA esclusa) / (VAT excluded)	... /DIMM2-3 (Dimmerabile)	... /EM (Emergenza)
A6-624S.084...	18	2430	184,00	-	324,00
A6-624S.112...	24	3250	214,00	255,00	354,00
A6-624S.140...	30	4060	255,00	300,00	395,00
A6-624S.168...	36	4870	297,00	329,00	437,00
A6-624S.196...	42	5680	347,00	372,00	487,00
A6-624S.224...	48	6500	380,00	408,00	520,00
A6-624S.252...	54	7310	420,00	457,00	560,00
A6-624S.280...	60	8120	470,00	539,00	610,00
A6-015/100* diffusore in polimetilmetacrilato microprismato / micro-prismatic polymethyl methacrylate screen			10,00		

\*codice e prezzo al metro / \*code and price per meter

## LINE PRO LIGHT

SISTEMA INCASSO CON BORDO  
RECESSED SYSTEM WITH TRIM

- 105°
- 3000K / 4000K
- IP 40
- CRI >80
- EEI A++
- RG 0
- Driver incluso  
Driver included

09 Bianco opaco  
A (esclusi) vedi p. 123  
(not included) see p. 123

mm	codice	Kg
845*	A6-624PL.084	1,8
1125*	A6-624PL.112	2,3
1405*	A6-624PL.140	2,8
1685*	A6-624PL.168	3,3
1965*	A6-624PL.196	4,1
2245*	A6-624PL.224	4,5
2525*	A6-624PL.252	5,1
2805*	A6-624PL.280	5,6

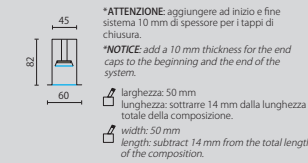

CODICE	W	Lm (3000K)	€ (IVA esclusa) / (VAT excluded)	... /DIMM2-3 (Dimmerabile)	... /EM (Emergenza)
A6-624PL.084...	27	3300	201,00	240,00	341,00
A6-624PL.112...	35	4400	235,00	278,00	375,00
A6-624PL.140...	44	5500	280,00	328,00	420,00
A6-624PL.168...	53	6600	325,00	360,00	465,00
A6-624PL.196...	62	7700	380,00	405,00	520,00
A6-624PL.224...	71	8800	416,00	446,00	556,00
A6-624PL.252...	80	9900	460,00	495,00	600,00
A6-624PL.280...	88	11000	515,00	590,00	655,00
A6-015/100* diffusore in polimetilmetacrilato microprismato / micro-prismatic polymethyl methacrylate screen			10,00		

\*codice e prezzo al metro / \*code and price per meter

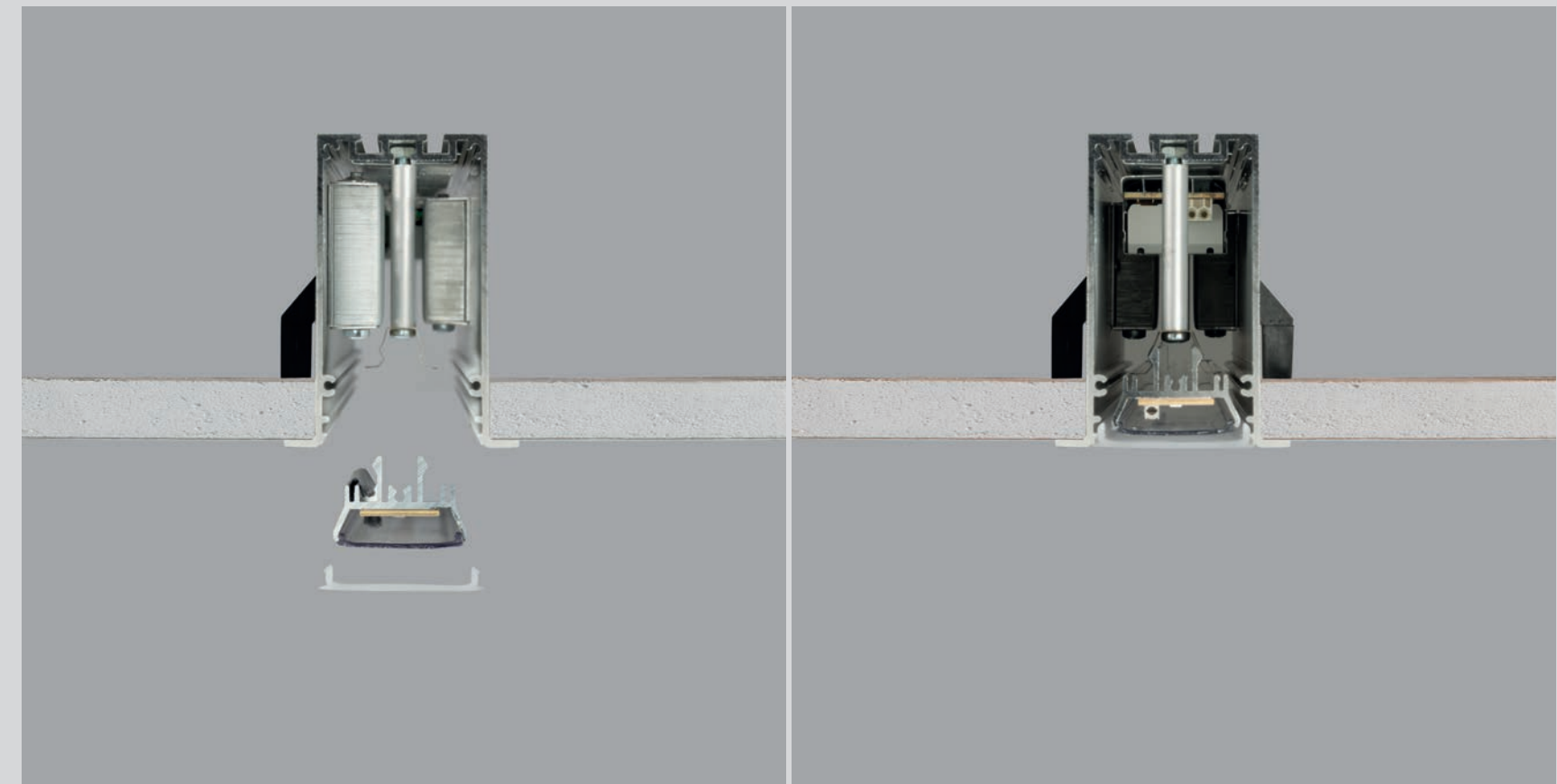



Showroom ceramiche Zaninoni, Bernareggio (MB)

## LINE PRO

SISTEMA INCASSO SENZA BORDO  
TRIMLESS RECESSED SYSTEM

- 105°
- 3000K / 4000K
- IP 40
- CRI >80
- EEI A++
- RG 0
- Driver incluso  
Driver included

09 Bianco opaco  
 A (esclusi) vedi p. 123  
(not included) see p. 123

mm	codice	Kg
845*	A6-626P.084	1,8
1125*	A6-626P.112	2,3
1405*	A6-626P.140	2,8
1685*	A6-626P.168	3,3
1965*	A6-626P.196	4,1
2245*	A6-626P.224	4,5
2525*	A6-626P.252	5,1
2805*	A6-626P.280	5,6

\*ATTENZIONE: aggiungere ad inizio e fine sistema 2,5 mm di spessore per tappi di chiusura.  
\*NOTICE: add a 2.5 mm thickness for the end caps to the beginning and the end of the system.  
 larghezza: 47 mm  
lunghezza: aggiungere 9 mm alla lunghezza totale della composizione.  
width: 47 mm  
length: add 9 mm to the total length of the composition.

CODICE	W	Lm (3000K)	€ (IVA esclusa) / (VAT excluded)	... /DIMM2-3 (Dimmerabile)	... /EM (Emergenza)
A6-626P.084...	36	4500	248,00	286,00	388,00
A6-626P.112...	48	6000	297,00	350,00	437,00
A6-626P.140...	60	7500	353,00	398,00	493,00
A6-626P.168...	72	9000	422,00	450,00	562,00
A6-626P.196...	84	10500	500,00	594,00	640,00
A6-626P.224...	96	12000	549,00	645,00	689,00
A6-626P.252...	108	13500	610,00	715,00	750,00
A6-626P.280...	120	15000	690,00	770,00	830,00
A6-015/100* diffusore in polimetilmetacrilato microprismato / micro-prismatic polymethyl methacrylate screen			10,00		

\*codice e prezzo al metro / \*code and price per meter

## LINE SOFT

SISTEMA INCASSO SENZA BORDO  
TRIMLESS RECESSED SYSTEM

- 105°
- 3000K / 4000K
- IP 40
- CRI >80
- EEI A++
- RG 0
- Driver incluso  
Driver included

09 Bianco opaco  
 A (esclusi) vedi p. 123  
(not included) see p. 123

mm	codice	Kg
845*	A6-626S.084	1,8
1125*	A6-626S.112	2,3
1405*	A6-626S.140	2,8
1685*	A6-626S.168	3,3
1965*	A6-626S.196	4,1
2245*	A6-626S.224	4,5
2525*	A6-626S.252	5,1
2805*	A6-626S.280	5,6

\*ATTENZIONE: aggiungere ad inizio e fine sistema 2,5 mm di spessore per tappi di chiusura.  
\*NOTICE: add a 2.5 mm thickness for the end caps to the beginning and the end of the system.  
 larghezza: 47 mm  
lunghezza: aggiungere 9 mm alla lunghezza totale della composizione.  
width: 47 mm  
length: add 9 mm to the total length of the composition.

CODICE	W	Lm (3000K)	€ (IVA esclusa) / (VAT excluded)	... /DIMM2-3 (Dimmerabile)	... /EM (Emergenza)
A6-626S.084...	18	2430	182,00	-	322,00
A6-626S.112...	24	3250	224,00	256,00	364,00
A6-626S.140...	30	4060	265,00	307,00	405,00
A6-626S.168...	36	4870	301,00	329,00	441,00
A6-626S.196...	42	5680	351,00	384,00	491,00
A6-626S.224...	48	6500	393,00	426,00	533,00
A6-626S.252...	54	7310	434,00	470,00	574,00
A6-626S.280...	60	8120	493,00	560,00	633,00
A6-015/100* diffusore in polimetilmetacrilato microprismato / micro-prismatic polymethyl methacrylate screen			10,00		

\*codice e prezzo al metro / \*code and price per meter

## LINE PRO LIGHT

SISTEMA INCASSO SENZA BORDO  
TRIMLESS RECESSED SYSTEM

- 105°
- 3000K / 4000K
- IP 40
- CRI >80
- EEI A++
- RG 0
- Driver incluso  
Driver included

09 Bianco opaco  
 A (esclusi) vedi p. 123  
(not included) see p. 123

mm	codice	Kg
845*	A6-626PL.084	1,8
1125*	A6-626PL.112	2,3
1405*	A6-626PL.140	2,8
1685*	A6-626PL.168	3,3
1965*	A6-626PL.196	4,1
2245*	A6-626PL.224	4,5
2525*	A6-626PL.252	5,1
2805*	A6-626PL.280	5,6

\*ATTENZIONE: aggiungere ad inizio e fine sistema 2,5 mm di spessore per tappi di chiusura.  
\*NOTICE: add a 2.5 mm thickness for the end caps to the beginning and the end of the system.  
 larghezza: 47 mm  
lunghezza: aggiungere 9 mm alla lunghezza totale della composizione.  
width: 47 mm  
length: add 9 mm to the total length of the composition.

CODICE	W	Lm (3000K)	€ (IVA esclusa) / (VAT excluded)	... /DIMM2-3 (Dimmerabile)	... /EM (Emergenza)
A6-626PL.084...	27	3300	200,00	245,00	340,00
A6-626PL.112...	35	4400	245,00	280,00	385,00
A6-626PL.140...	44	5500	290,00	336,00	430,00
A6-626PL.168...	53	6600	330,00	360,00	470,00
A6-626PL.196...	62	7700	385,00	420,00	525,00
A6-626PL.224...	71	8800	430,00	466,00	570,00
A6-626PL.252...	80	9900	475,00	515,00	615,00
A6-626PL.280...	88	11000	540,00	614,00	680,00
A6-015/100* diffusore in polimetilmetacrilato microprismato / micro-prismatic polymethyl methacrylate screen			10,00		

\*codice e prezzo al metro / \*code and price per meter

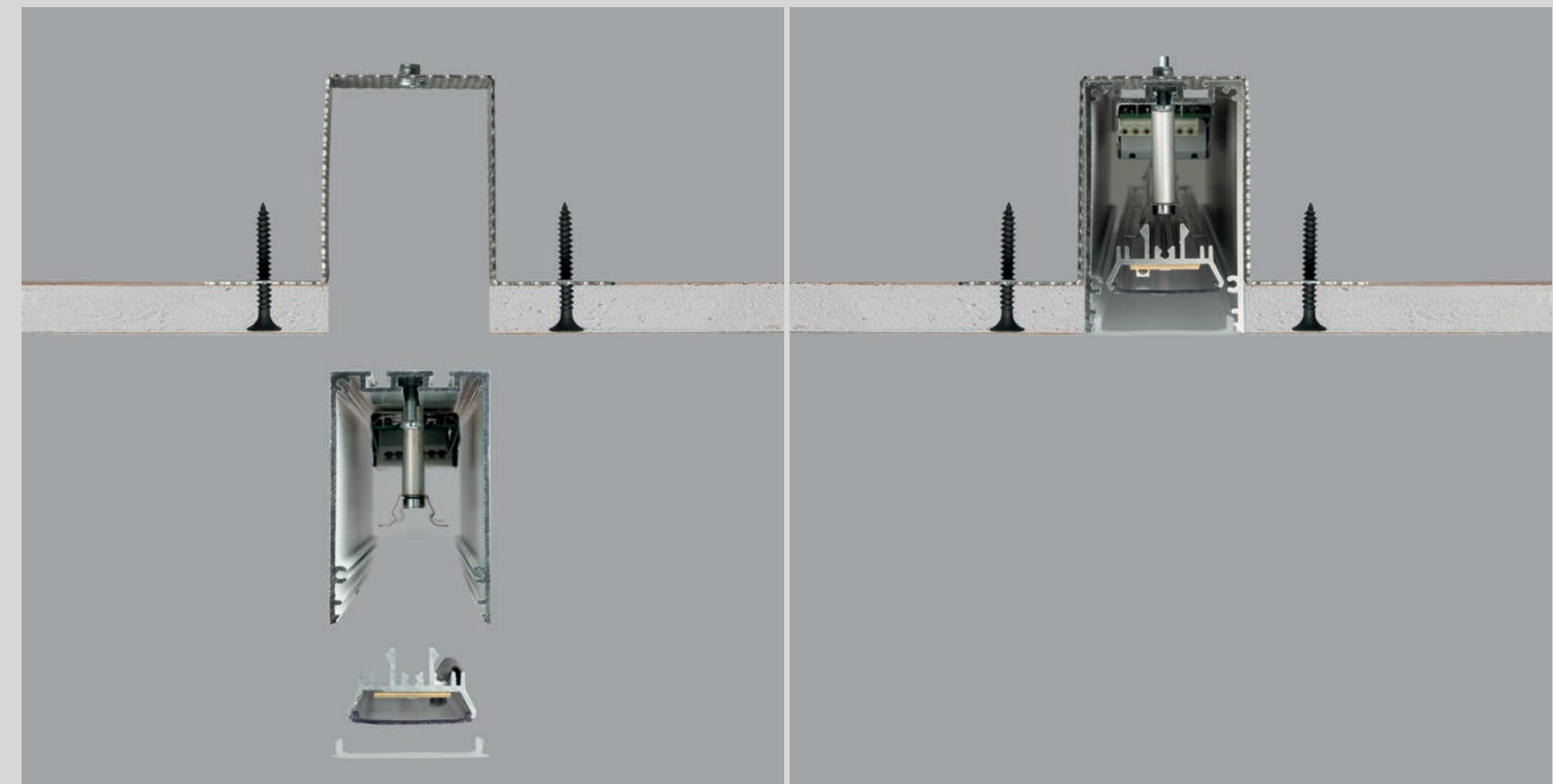

LINE ACCESSORI / ACCESSORIES  
SISTEMA SOSPENSIONE / HANGING SYSTEM

CODICE	DESCRIZIONE / DESCRIPTION	€ (IVA esclusa) / (VAT excluded)
A6-011	Terminali di chiusura (coppia). Colore 02-09 / <i>End caps (pair). Colour 02-09</i>	19,00
A6-019.3	Rosone con cavo di alimentazione 3x0,75 mm <sup>2</sup> 200 cm. Colore 02-09 <i>Ceiling cup with supply cable. Colour 02-09 3x0,75mm<sup>2</sup> 200 cm</i>	38,00
A6-019.4	Rosone con cavo di alimentazione 4x0,75 mm <sup>2</sup> 200 cm, per installazioni con doppia accensione. Colore 02-09 <i>Ceiling cup with supply cable 4x0,75mm<sup>2</sup> 200 cm, for double switch use. Colour 02-09</i>	42,00
A6-019.5	Rosone con cavo di alimentazione 5x0,75 mm <sup>2</sup> 200 cm, per installazioni dimmerabili o in emergenza. Colore 02-09 <i>Ceiling cup with supply cable 5x0,75mm<sup>2</sup> 200 cm, for dimming and emergency use. Colour 02-09</i>	52,00
A6-017	Cavi di sospensione 200 cm / <i>Suspension cables, 200 cm</i>	15,50
A6-012	Giunto lineare / <i>In-line connector</i>	4,30
X	Prolungamento + 45 mm per curva 90° (vedi p.157) / <i>Extension + 45 mm for a 90° corner (see p. 157)</i>	25,00
Y	Prolungamento + 45 mm per curva 90° (vedi p.157) / <i>Extension + 45 mm for a 90° corner (see p. 157)</i>	25,00
Z	Prolungamento + 45 mm per curva 90° (vedi p.157) / <i>Extension + 45 mm for a 90° corner (see p. 157)</i>	50,00
K	Prolungamento + 45 mm per curva 90° (vedi p.157) / <i>Extension + 45 mm for a 90° corner (see p. 157)</i>	50,00
W	Prolungamento + 45 mm per curva 90° (vedi p.157) / <i>Extension + 45 mm for a 90° corner (see p. 157)</i>	50,00
A6-015/100*	Diffusore in polimetilmetacrilato microprismato (codice e prezzo al metro) <i>Micro-prismatic polymethyl methacrylate diffuser (code per meter)</i>	10,00

altre tipologie di curva su richiesta / *customized corners on request*

LINE ACCESSORI / ACCESSORIES  
SISTEMA INCASSO CON BORDO / RECESSED SYSTEM WITH TRIM

CODICE	DESCRIZIONE / DESCRIPTION	€ (IVA esclusa) / (VAT excluded)
A6-021	Terminali di chiusura (coppia) / <i>End caps (pair)</i>	19,00
A6-012	Giunto lineare / <i>In-line connector</i>	4,30
X	Prolungamento + 48 mm per curva 90° (vedi p.157) / <i>Extension + 48 mm for a 90° corner (see p. 157)</i>	25,00
Y	Prolungamento + 48 mm per curva 90° (vedi p.157) / <i>Extension + 48 mm for a 90° corner (see p. 157)</i>	25,00
Z	Prolungamento + 48 mm per curva 90° (vedi p.157) / <i>Extension + 48 mm for a 90° corner (see p. 157)</i>	50,00
K	Prolungamento + 48 mm per curva 90° (vedi p.157) / <i>Extension + 48 mm for a 90° corner (see p. 157)</i>	50,00
W	Prolungamento + 48 mm per curva 90° (vedi p.157) / <i>Extension + 48 mm for a 90° corner (see p. 157)</i>	50,00
A6-015/100*	Diffusore in polimetilmetacrilato microprismato (codice e prezzo al metro) <i>Micro-prismatic polymethyl methacrylate diffuser (code per meter)</i>	10,00

altre tipologie di curva su richiesta / *customized corners on request*

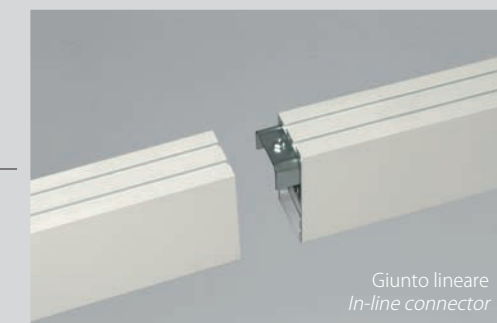

Giunto lineare  
*In-line connector*

LINE ACCESSORI / ACCESSORIES  
SISTEMA PLAFONE / CEILING SYSTEM

CODICE	DESCRIZIONE / DESCRIPTION	€ (IVA esclusa) / (VAT excluded)
A6-011	Terminali di chiusura (coppia). Colore 02-09 / <i>End caps (pair). Colour 02-09</i>	19,00
A6-012	Giunto lineare / <i>In-line connector</i>	4,30
X	Prolungamento + 45 mm per curva 90° (vedi p.157) / <i>Extension + 45 mm for a 90° corner (see p. 157)</i>	25,00
Y	Prolungamento + 45 mm per curva 90° (vedi p.157) / <i>Extension + 45 mm for a 90° corner (see p. 157)</i>	25,00
Z	Prolungamento + 45 mm per curva 90° (vedi p.157) / <i>Extension + 45 mm for a 90° corner (see p. 157)</i>	50,00
K	Prolungamento + 45 mm per curva 90° (vedi p.157) / <i>Extension + 45 mm for a 90° corner (see p. 157)</i>	50,00
W	Prolungamento + 45 mm per curva 90° (vedi p.157) / <i>Extension + 45 mm for a 90° corner (see p. 157)</i>	50,00
A6-015/100*	Diffusore in polimetilmetacrilato microprismato (codice e prezzo al metro) <i>Micro-prismatic polymethyl methacrylate diffuser (code per meter)</i>	10,00

altre tipologie di curva su richiesta / *customized corners on request*

LINE ACCESSORI / ACCESSORIES  
SISTEMA INCASSO SENZA BORDO / TRIMLESS RECESSED SYSTEM

CODICE	DESCRIZIONE / DESCRIPTION	€ (IVA esclusa) / (VAT excluded)
A6-011	Terminali di chiusura (coppia) / <i>End caps (pair)</i>	19,00
A6-012	Giunto lineare / <i>In-line connector</i>	4,30
X	Prolungamento + 45 mm per curva 90° (vedi p.157) / <i>Extension + 45 mm for a 90° corner (see p. 157)</i>	25,00
Y	Prolungamento + 45 mm per curva 90° (vedi p.157) / <i>Extension + 45 mm for a 90° corner (see p. 157)</i>	25,00
Z	Prolungamento + 45 mm per curva 90° (vedi p.157) / <i>Extension + 45 mm for a 90° corner (see p. 157)</i>	50,00
K	Prolungamento + 45 mm per curva 90° (vedi p.157) / <i>Extension + 45 mm for a 90° corner (see p. 157)</i>	50,00
W	Prolungamento + 45 mm per curva 90° (vedi p.157) / <i>Extension + 45 mm for a 90° corner (see p. 157)</i>	50,00
A6-015/100*	Diffusore in polimetilmetacrilato microprismato (codice e prezzo al metro) <i>Micro-prismatic polymethyl methacrylate diffuser (code per meter)</i>	10,00

altre tipologie di curva su richiesta / *customized corners on request*

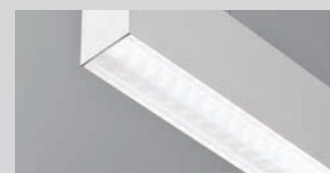









\*DIFFUSORE IN POLIMETILMETACRILATO MICROPRISMATO / *MICRO-PRISMATIC POLYMETHYL METHACRYLATE DIFFUSER*

Schermo in polimetilmetacrilato microprismato adatto a limitare la luminanza diretta dell'apparecchio, rendendolo idoneo per installazioni in ambienti in cui viene richiesto un indice UGR<19 (normativa UNI-11165 e EN 12464-1), quali uffici e postazioni con videoterminali.

*The micro-prismatic polymethyl methacrylate screen reduces the luminaire's direct lighting and permits Line to be used in spaces requiring an excellent visual comfort (UGR<19, standards UNI-11165 and EN 12464), like offices and workstations with video terminals.*

# MINILINE<sup>24</sup>

SISTEMA INCASSO / RECESSED SYSTEM

-  110°
-  TC 3000K / 4000K
-  IP 40
-  CRI >80
-  EEI A++
-  RG 0
-  D Driver 24Vdc escluso (p. 149)  
24Vdc driver not included (p. 149)
-  09 Bianco opaco  
(esclusi) vedi p. 124  
(not included) see p. 124
-  A

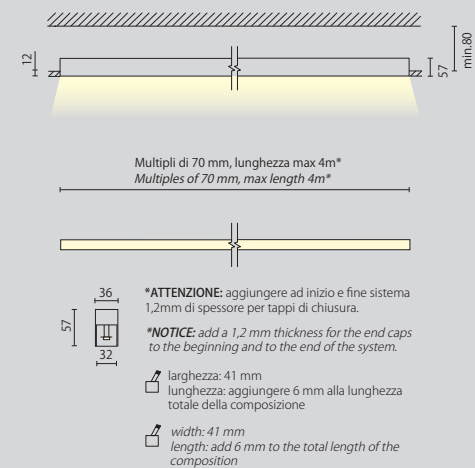

CODICE	W	Lm (3000K)	€ (IVA esclusa) / (VAT excluded)
A6-641.100...*	22	2800	179,00

controcassa inclusa / flush box included  
\*codice e prezzo al metro / \*code and price per meter

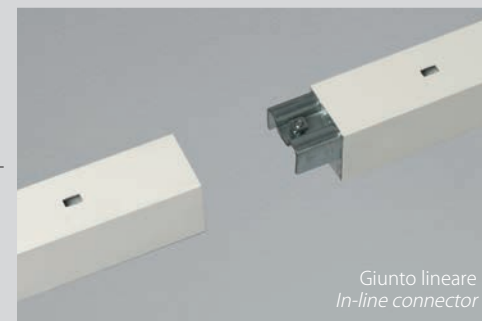

## MINILINE ACCESSORI / ACCESSORIES

CODICE	DESCRIZIONE / DESCRIPTION	€ (IVA esclusa) / (VAT excluded)
A6-031	Terminali di chiusura (coppia) / End caps (pair)	9,00
A6-032	Giunto lineare / In-line connector	4,00
A6-033	Terminali di chiusura per cassaforma (coppia) / End caps for flush box (pair)	10,00
X	Prolungamento + 32 mm per curva 90° (vedi p.157) / Extension + 32 mm for a 90° corner (see p. 157)	25,00
Y	Prolungamento + 32 mm per curva 90° (vedi p.157) / Extension + 32 mm for a 90° corner (see p. 157)	25,00
Z	Prolungamento + 32 mm per curva 90° (vedi p.157) / Extension + 32 mm for a 90° corner (see p. 157)	50,00
K	Prolungamento + 32 mm per curva 90° (vedi p.157) / Extension + 32 mm for a 90° corner (see p. 157)	50,00
W	Prolungamento + 32 mm per curva 90° (vedi p.157) / Extension + 32 mm for a 90° corner (see p. 157)	50,00
0800/DIM	Dispositivo di dimmerazione (DIMMER) / Dimming kit	88,00
0800/EM	Kit di emergenza con pacco batterie / Emergency kit with batteries	125,00

altre tipologie di curva su richiesta / customized corners on request



Studio legale, Bergamo



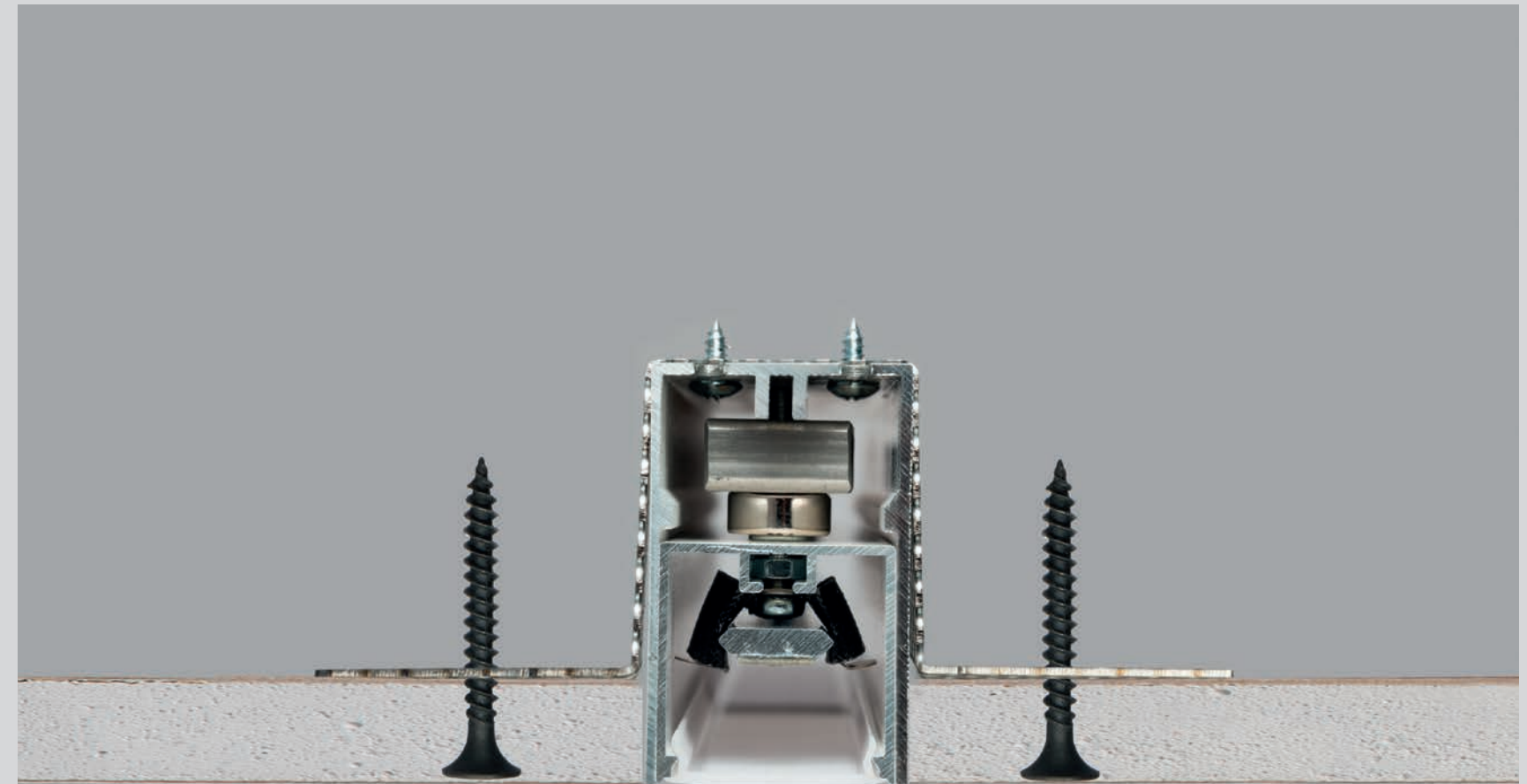
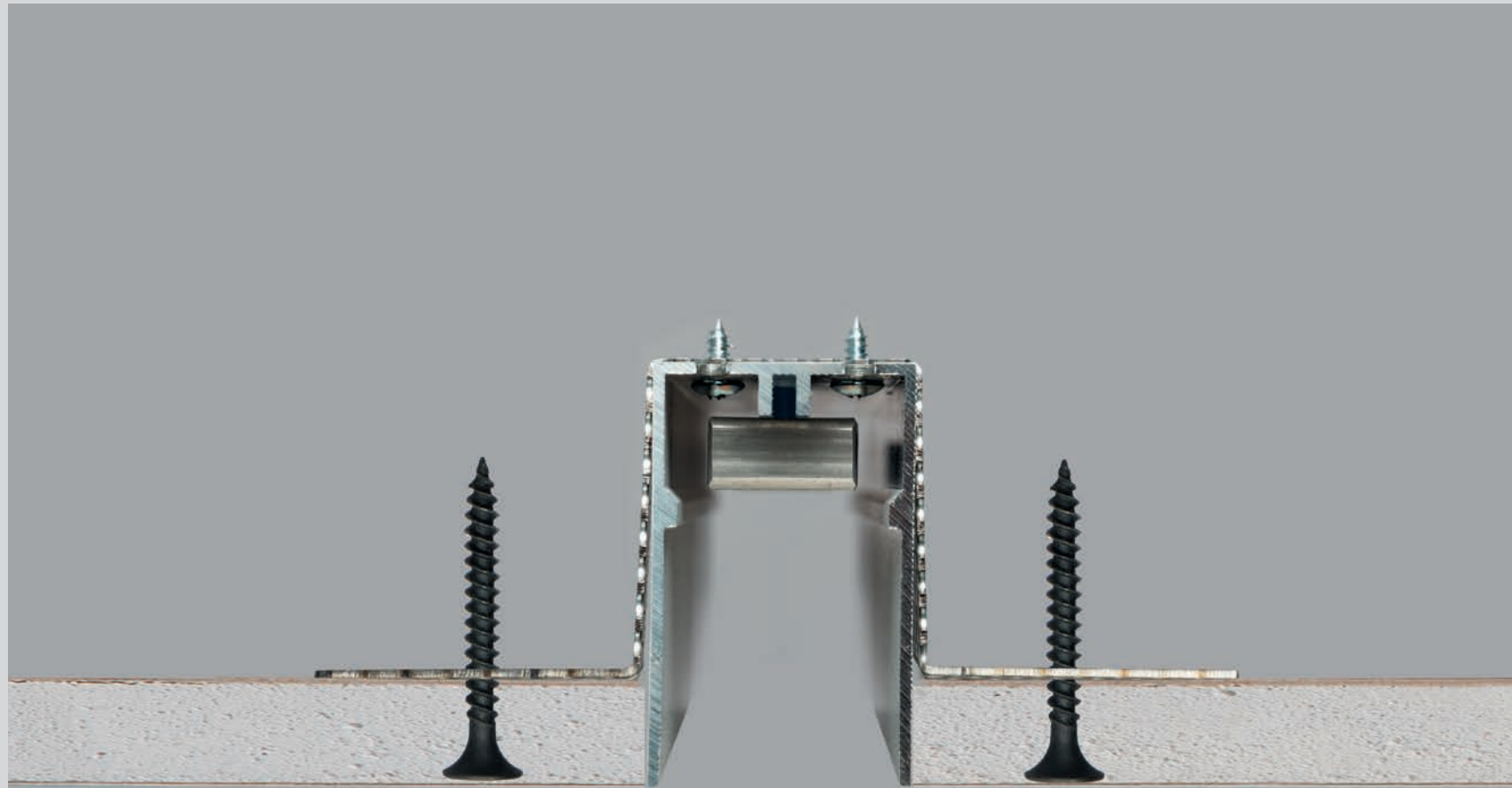



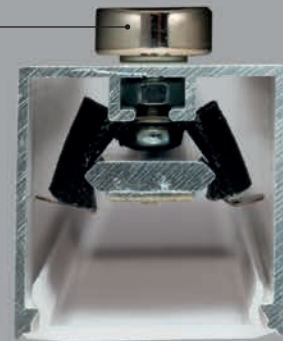





SISTEMA DI AGGANCIO RAPIDO TRAMITE MAGNETE  
*QUICK MAGNETIC ATTACHMENT SYSTEM*



## AT

SISTEMA PARETE / PLAFONE  
WALL / CEILING SYSTEM

	100°
	3000K / 4000K
	20
	>80
	A+
	0
	Driver 24Vdc escluso (p. 149) 24Vdc driver not included (p. 149)
	08 Bianco satinato

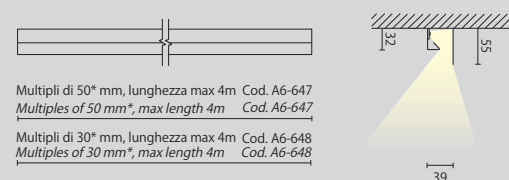

Multipli di 50\* mm, lunghezza max 4m Cod. A6-647  
Multiples of 50 mm\*, max length 4m Cod. A6-647

Multipli di 30\* mm, lunghezza max 4m Cod. A6-648  
Multiples of 30 mm\*, max length 4m Cod. A6-648

**\*ATTENZIONE:** aggiungere 12,4 mm sulla lunghezza totale della composizione.









**\*NOTICE:** add 12,40 mm on the total length of the composition.

CODICE	W	Lm (3000K)	€ (IVA esclusa) / (VAT excluded)
A6-647.100...*	12 (120 led)	1200	78,00
A6-648.100...*	25 (280 led)	2500	85,00
A6-028	Terminali di chiusura (coppia) / End caps (pair)		18,00
A6-029	Giunto lineare / In-line connector		5,00
0800/DIM	Dispositivo di dimmerazione (DIMMER) / Dimming kit		88,00
0800/EM	Kit di emergenza con pacco batterie / Emergency kit with batteries		125,00

\*codice e prezzo al metro / \*code and price per meter

## AT

SISTEMA INCASSO / RECESSED SYSTEM

	100°
	3000K / 4000K
	20
	>80
	A+
	0
	Driver 24Vdc escluso (p. 149) 24Vdc driver not included (p. 149)
	08 Bianco satinato







Multipli di 50\* mm, lunghezza max 4m Cod. A6-645  
Multiples of 50 mm\*, max length 4m Cod. A6-645

Multipli di 30\* mm, lunghezza max 4m Cod. A6-646  
Multiples of 30 mm\*, max length 4m Cod. A6-646

**\*ATTENZIONE:** aggiungere a inizio e fine composizione 2,5 mm

**\*NOTICE:** add a 2,5 mm thickness to the beginning and the end of the composition.

 larghezza: 45 mm  
 lunghezza: aggiungere 12 mm alla lunghezza totale della composizione.

 width: 45 mm  
 length: add 12 mm to the total length of the composition.

CODICE	W	Lm (3000K)	€ (IVA esclusa) / (VAT excluded)
A6-645.100...*	12 (120 led)	1200	110,00
A6-646.100...*	25 (280 led)	2500	117,00
A6-030	Terminali di chiusura (coppia) / End caps (pair)		10,00
A6-029	Giunto lineare / In-line connector		5,00
0800/DIM	Dispositivo di dimmerazione (DIMMER) / Dimming kit		88,00
0800/EM	Kit di emergenza con pacco batterie / Emergency kit with batteries		125,00

\*codice e prezzo al metro / \*code and price per meter



Abitazione privata, Arch. Loda



## ESPO'

SISTEMA PARETE / WALL SYSTEM

- 75°
- TC 3000K / 4000K
- IP 40
- CRI >80
- EEI A+
- RG 0
- D Driver 24Vdc escluso (p. 149)  
24Vdc driver not included (p. 149)

**08** Bianco satinato  
(altri colori a richiesta)  
(other colours on request)

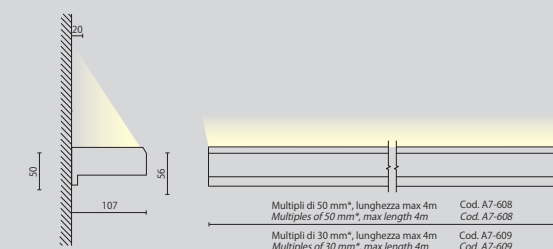

\*ATTENZIONE: aggiungere 10 mm sulla lunghezza totale della composizione.  
\*NOTICE: add 10 mm on the total length of the composition.

CODICE	W	Lm (3000K)	€ (IVA esclusa) / (VAT excluded)
A7-608.100...*	12 (120 led)	1200	118,00
A7-609.100...*	25 (280 led)	2500	125,00
A7-002	Terminali di chiusura (coppia) / End caps (pair)		30,00
A7-000	Giunto lineare / In-line connector		8,00
0800/DIM	Dispositivo di dimmerazione (DIMMER) / Dimming kit		88,00
0800/EM	Kit di emergenza con pacco batterie / Emergency kit with batteries		125,00

\*codice e prezzo al metro / \*code and price per meter



## ESPO' 2

SISTEMA PARETE / PLAFONE  
WALL / CEILING SYSTEM

- 75°
- TC 3000K / 4000K
- IP 40
- CRI >80
- EEI A+
- RG 0
- D Driver 24Vdc escluso (p. 149)  
24Vdc driver not included (p. 149)

**08** Bianco satinato  
(altri colori a richiesta)  
(other colours on request)

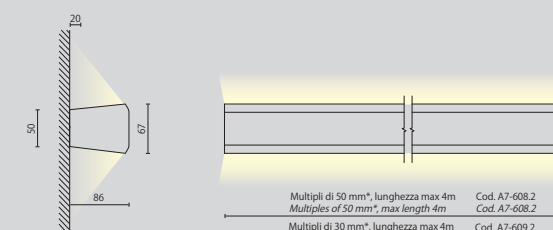

\*ATTENZIONE: aggiungere 10 mm sulla lunghezza totale della composizione.  
\*NOTICE: add 10 mm on the total length of the composition.

CODICE	W	Lm (3000K)	€ (IVA esclusa) / (VAT excluded)
A7-608.2.100...*	2x12 (2x120 led)	2x1200	169,00
A7-609.2.100...*	2x25 (2x280 led)	2x2500	183,00
A7-002.2	Terminali di chiusura (coppia) / End caps (pair)		32,00
A7-000.2	Giunto lineare / In-line connector		8,00
0800/DIM	Dispositivo di dimmerazione (DIMMER) / Dimming kit		88,00
0800/EM	Kit di emergenza con pacco batterie / Emergency kit with batteries		125,00

\*codice e prezzo al metro / \*code and price per meter

## FROY

SISTEMA PARETE / PLAFONE  
WALL / CEILING SYSTEM

	105°
	3000K / 4000K
	40
	>80
	A+
	0
	Driver 24Vdc escluso (p. 149) 24Vdc driver not included (p. 149)
	<b>02</b> Nero opaco
	<b>09</b> Bianco opaco

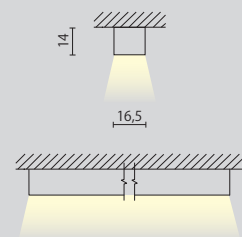

Multipli di 50 mm\*, lunghezza max 4m  
Multiples of 50 mm\*, max length 4m

Cod. A7-603.F  
Cod. A7-603.F

Multipli di 30 mm\*, lunghezza max 4m  
Multiples of 30 mm\*, max length 4m

Cod. A7-604.F  
Cod. A7-604.F

**\*ATTENZIONE:** aggiungere 17,40 mm sulla lunghezza totale della composizione.

**\*NOTICE:** add 17,4 mm on the total length of the composition.



## LATY

SISTEMA PARETE / PLAFONE  
WALL / CEILING SYSTEM

	105°
	3000K / 4000K
	40
	>80
	A+
	0
	Driver 24Vdc escluso (p. 149) 24Vdc driver not included (p. 149)
	<b>02</b> Nero opaco
	<b>09</b> Bianco opaco

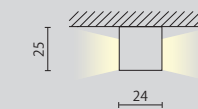

Multipli di 50 mm\*, lunghezza max 4m  
Multiples of 50 mm\*, max length 4m

Cod. A7-603.L  
Cod. A7-603.L

Multipli di 30 mm\*, lunghezza max 4m  
Multiples of 30 mm\*, max length 4m

Cod. A7-604.L  
Cod. A7-604.L

**\*ATTENZIONE:** aggiungere 17,40 mm sulla lunghezza totale della composizione.

**\*NOTICE:** add 17,4 mm on the total length of the composition.

CODICE	W	Lm (3000K)	€ (IVA esclusa) / (VAT excluded)
A7-603.F100*	12 (120 led)	1200	88,00
A7-604.F100*	25 (280 led)	2500	95,00
A7-004F	Terminali di chiusura (coppia) / End caps (pair)		8,00
0800/DIM	Dispositivo di dimmerazione (DIMMER) / Dimming kit		88,00
0800/EM	Kit di emergenza con pacco batterie / Emergency kit with batteries		125,00

\*codice e prezzo al metro / \*code and price per meter

CODICE	W	Lm (3000K)	€ (IVA esclusa) / (VAT excluded)
A7-603.L100*	2x12 (2x120 led)	2x1200	136,00
A7-604.L100*	2x17 (2x280 led)	2x2500	150,00
A7-004L	Terminali di chiusura (coppia) / End caps (pair)		9,00
0800/DIM	Dispositivo di dimmerazione (DIMMER) / Dimming kit		88,00
0800/EM	Kit di emergenza con pacco batterie / Emergency kit with batteries		125,00

\*codice e prezzo al metro / \*code and price per meter

## ASY

SISTEMA PARETE / PLAFONE  
WALL / CEILING SYSTEM

	-
	3000K / 4000K
	40
	>80
	A+
	0
	Driver 24Vdc escluso (p. 149) 24Vdc driver not included (p. 149)
	<b>02</b> Nero opaco
	<b>09</b> Bianco opaco

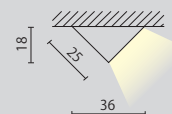

Multipli di 50 mm\*, lunghezza max 4m  
Multiples of 50 mm\*, max length 4m

Cod. A7-603.A  
Cod. A7-603.A

Multipli di 30 mm\*, lunghezza max 4m  
Multiples of 30 mm\*, max length 4m

Cod. A7-604.A  
Cod. A7-604.A

**\*ATTENZIONE:** aggiungere 17,40 mm sulla lunghezza totale della composizione.

**\*NOTICE:** add 17,4 mm on the total length of the composition.

CODICE	W	Lm (3000K)	€ (IVA esclusa) / (VAT excluded)
A7-603.A100...*	12 (120 led)	1200	88,00
A7-604.A100...*	25 (280 led)	2500	95,00
A7-004A	Terminali di chiusura (coppia) / End caps (pair)		8,00
0800/DIM	Dispositivo di dimmerazione (DIMMER) / Dimming kit		88,00
0800/EM	Kit di emergenza con pacco batterie / Emergency kit with batteries		125,00

\*codice e prezzo al metro / \*code and price per meter



Abitazione privata, Varese



02 Nero opaco

09 Bianco opaco

## FROY PROFILO VUOTO / EMPTY BODY SECTION

Profilo in alluminio verniciato completo di schermo in policarbonato satinato. Driver da 24Vdc escluso.  
Empty body section made from epoxy polyester powder coated aluminium. Complete with frosted polycarbonate screen.  
24Vdc driver not included.

CODICE	DESCRIZIONE / DESCRIPTION	€ (IVA esclusa) / (VAT excluded)
ESAL200F	Froy 2 metri / Froy 200 cm	30,00
ESAL100F	Froy taglio a misura*, Max 4mt / Froy customized length*, Max 4mt	20,00
A7-004F	tappi (coppia), in alluminio sinterizzato / End caps (pair), in sintered aluminium	8,00
A7-005F	elemento di fissaggio (singolo), in alluminio sinterizzato fixing support (single), in sintered aluminium	2,80

\*il codice si riferisce al profilo di lunghezza 100 cm / \*The code refers to a module with a length measuring 100 cm

Per richieste di profili con lunghezze differenti, sostituire il codice 100 con la lunghezza in centimetri desiderata. Calcolare il prezzo in proporzione.  
To order modules in different lengths substitute code 100 with the desired length in centimeters. Calculate the price in proportion.



02 Nero opaco

09 Bianco opaco

## ASY PROFILO VUOTO / EMPTY BODY SECTION

Profilo in alluminio verniciato completo di schermo in policarbonato satinato. Driver da 24Vdc escluso.  
Empty body section made from epoxy polyester powder coated aluminium. Complete with frosted polycarbonate screen.  
24Vdc driver not included.

CODICE	DESCRIZIONE / DESCRIPTION	€ (IVA esclusa) / (VAT excluded)
ESAL200A	Asy 2 metri / Froy 200 cm	35,00
ESAL100A	Asy taglio a misura*, Max 4mt / Froy customized length*, Max 4mt	24,00
A7-004A	tappi (coppia), in alluminio sinterizzato / End caps (pair), in sintered aluminium	8,00
A7-005A	elemento di fissaggio (singolo), in alluminio sinterizzato fixing support (single), in sintered aluminium	2,80

\*il codice si riferisce al profilo di lunghezza 100 cm / \*The code refers to a module with a length measuring 100 cm

Per richieste di profili con lunghezze differenti, sostituire il codice 100 con la lunghezza in centimetri desiderata. Calcolare il prezzo in proporzione.  
To order modules in different lengths substitute code 100 with the desired length in centimeters. Calculate the price in proportion.



02 Nero opaco

09 Bianco opaco

## LATY PROFILO VUOTO / EMPTY BODY SECTION

Profilo in alluminio verniciato completo di schermo in policarbonato satinato. Driver da 24Vdc escluso.  
Empty body section made from epoxy polyester powder coated aluminium. Complete with frosted polycarbonate screen.  
24Vdc driver not included.

CODICE	DESCRIZIONE / DESCRIPTION	€ (IVA esclusa) / (VAT excluded)
ESAL200L	Laty 2 metri / Froy 200 cm	44,00
ESAL100L	Laty taglio a misura*, Max 4mt / Froy customized length*, Max 4mt	29,00
A7-004L	tappi (coppia), in alluminio sinterizzato / End caps (pair), in sintered aluminium	9,00
A7-005L	elemento di fissaggio (singolo), in alluminio sinterizzato fixing support (single), in sintered aluminium	2,80

\*il codice si riferisce al profilo di lunghezza 100 cm / \*The code refers to a module with a length measuring 100 cm

Per richieste di profili con lunghezze differenti, sostituire il codice 100 con la lunghezza in centimetri desiderata. Calcolare il prezzo in proporzione.  
To order modules in different lengths substitute code 100 with the desired length in centimeters. Calculate the price in proportion.

## ACCESSORI ESCLUSI / ACCESSORIES NOT INCLUDED

### LED 24Vdc LUNGHEZZA 5 METRI / LED 24Vdc, 5M LONG

CODICE	LED/mt	TC (K)	W/mt	Lm/mt	€ (IVA esclusa) / (VAT excluded)
STR50012120.30	120	3000	12	1200	84,00
STR50012120.40	120	4000	12	1320	84,00
STR50025280.30	280	3000	25	2500	110,00
STR50025280.40	280	4000	25	2650	110,00

LED strip mt 5 con biadesivo termico 3M / 5 mt strip LED with double-sided thermal adhesive tape  
La versione da 120 LED/mt è divisibile in tagli da 5 cm / 120 LED/mt version divisible every 5 cm  
La versione da 280 LED/mt è divisibile in tagli da 2,5 cm / 240 LED/mt version divisible every 2,5 cm  
Alimentazione 24Vdc / 24Vdc power supply

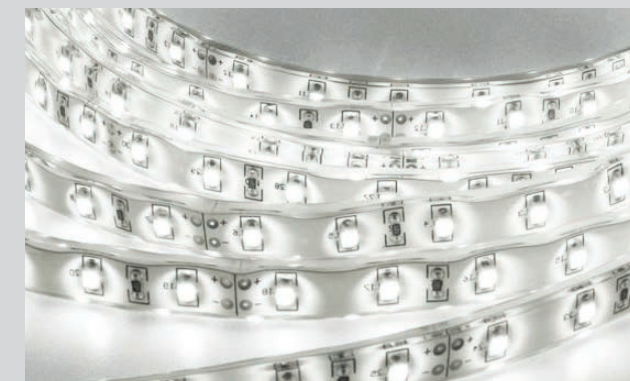

### INTERRUTTORE ON/OFF TOUCH / TOUCH SWITCH ON/OFF

Interruttore touch con LED blu di segnalazione della zona di accensione/spegnimento.  
Spazio necessario per l'installazione minimo 80 mm. Fornito senza cavi.  
Necessita di connessione elettrica tramite saldatura.

Touch switch with blue LED on/off indicator.  
Minimal space required for installation: 80 mm. Cables not included.  
Electrical connection by welding is required.

CODICE	W	DIMENSIONI (LxWxH)	€ (IVA esclusa) / (VAT excluded)
07-010	Max 36	60x11,5mm	50,00

### DRIVER IN TENSIONE CONTINUA 24Vdc / DIRECT CURRENT DRIVER 24Vdc

CODICE	W	IP	DIMENSIONI (LxWxH)	€ (IVA esclusa) / (VAT excluded)
0730	20	67	118x35x26mm	26,00
0731	35	67	148x40x30mm	38,00
0732	60	67	163x43x32mm	45,00
0733	100	67	190x52x37mm	74,00
0734	150	67	191x67x38mm	120,00
0735	185	67	229x68x39mm	180,00
0736	240	67	251x68x39mm	200,00
0731/DIMM 2-3	35	20	195x43x30mm	96,00
0732/DIMM 2-3	60	20	225x43x30mm	116,00
0733/DIMM 2-3	100	20	295x43x30mm	144,00
0734/DIMM 2-3	150	20	325x43x30mm	184,00

ESTERNI  
OUTDOOR

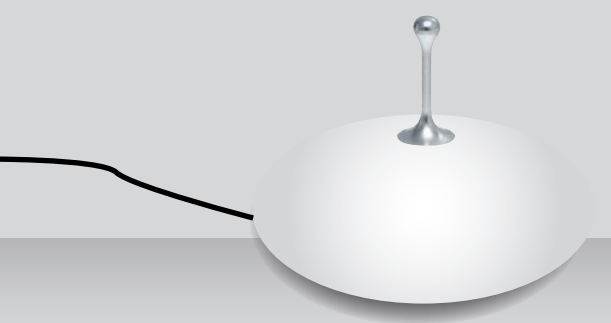



## CABANA

ESTERNO / OUTDOOR

- IP 55
- SL sorgente luminosa: tornado ES E27
- 08 Bianco satinato

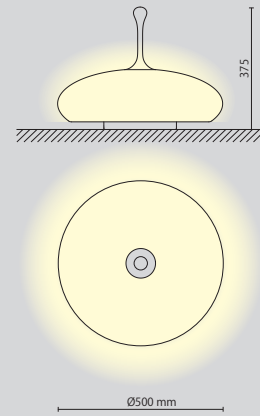

CODICE	W	€ (IVA esclusa) / (VAT excluded)
A1-100	3x Max 15	260,00



## HAIKU GRANDE

ESTERNO / OUTDOOR

- 100°
- TC 3000K / 4000K
- IP 55
- CRI >80
- EEL A
- RG 1
- D Driver non richiesto / Driver not requested
- 04 Nero manganese
- 22 Grigio
- 27 Ruggine

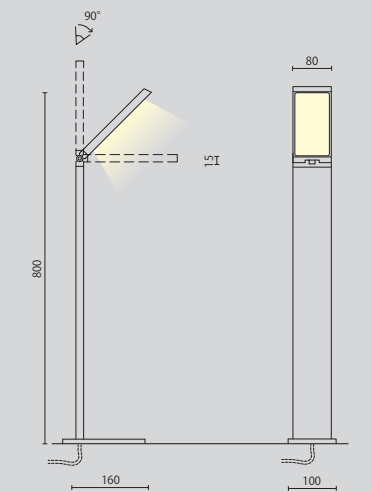

CODICE	W	Lm (3000K)	€ (IVA esclusa) / (VAT excluded)
A1-607.09...	9	780	220,00

non utilizzare sorgenti alogene o ad incandescenza / do not use halogen or incandescent lamps



## HAIKU PICCOLO

ESTERNO / OUTDOOR

- 100°
- TC 3000K / 4000K
- IP 55
- CRI >80
- EEL A
- RG 1
- D Driver non richiesto / Driver not requested
- 04 Nero manganese
- 22 Grigio
- 27 Ruggine

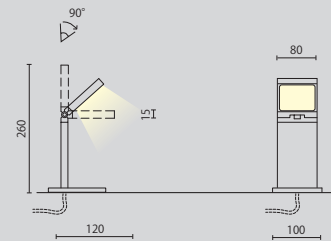

CODICE	W	Lm (3000K)	€ (IVA esclusa) / (VAT excluded)
A1-606...	4	360	180,00



## OYS

ESTERNO / OUTDOOR

- 25°
- TC 3000K / 4000K
- IP 65
- CRI >80
- EEL A+
- RG 1
- D Driver non richiesto / Driver not requested
- 02 Nero opaco

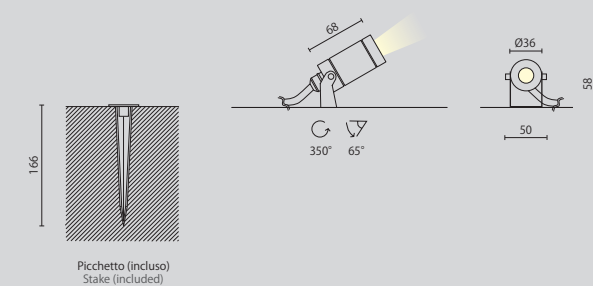

CODICE	W	Lm (3000K)	€ (IVA esclusa) / (VAT excluded)
A1-608.03...	3	170	78,00

picchetto incluso / stake included







## JAGO

ESTERNO / OUTDOOR

100°
TC 3000K / 4000K
IP 67
CRI >80
EEL A+
RG 0
D Driver non richiesto Driver not requested
23 Acciaio
IK 10

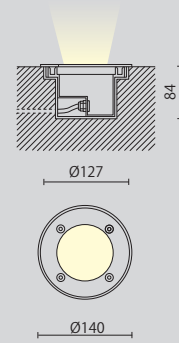

CODICE	W	Lm (3000K)	€ (IVA esclusa) / (VAT excluded)
A1-620.04... 0500	4,5	420	115,00 15,00
cassaforma in nylon obbligatoria (esclusa) / nylon flush box requested (not included)			



## PLEUS MONOEMISSIONE

ESTERNO / OUTDOOR

80°
TC 3000K / 4000K
IP 67
CRI >80
EEL A+
RG 0
D Driver remoto incluso Remote driver included
26 Grigio titanio
IK 07

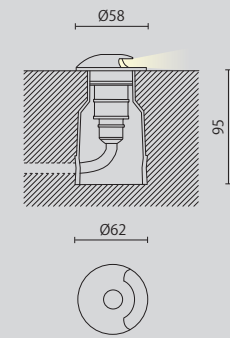

CODICE	W	Lm (3000K)	€ (IVA esclusa) / (VAT excluded)
A1-655.1...	3	40	45,00

controcassa inclusa / flush box included



## PLEUS BIEMISSIONE

ESTERNO / OUTDOOR

80°
TC 3000K / 4000K
IP 67
CRI >80
EEL A+
RG 0
D Driver remoto incluso Remote driver included
26 Grigio titanio
IK 07

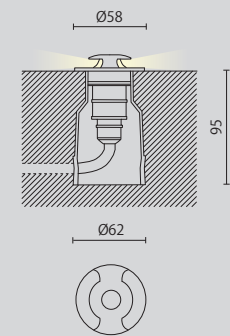

CODICE	W	Lm (3000K)	€ (IVA esclusa) / (VAT excluded)
A1-655.2...	3	60	45,00

controcassa inclusa / flush box included

# DATI TECNICI

TECHNICAL DATA

## COLORI / COLOURS

02	Nero opaco <i>Matt black</i>
03	Nero lucido <i>Glossy black</i>
04	Nero manganese <i>Manganese black</i>
05	Nero anodizzato <i>Anodized black</i>
08	Bianco satinato RAL 9003 <i>Frosted white RAL 9003</i>
09	Bianco opaco RAL 9010 <i>Matt white RAL 9010</i>
13	Oro <i>Gold</i>
14	Cromato <i>Chrome</i>
16	Bronzo anodizzato <i>Anodized bronze</i>
20	Anodizzato naturale <i>Anodized natural</i>
22	Grigio RAL 9006 <i>Grey RAL 9006</i>
23	Acciaio <i>Steel</i>
26	Grigio titanio <i>Titanium grey</i>
27	Ruggine <i>Rust</i>
29	Bronzo metallizzato <i>Metalized bronze</i>
38	Grigio antracite <i>Charcoal grey</i>
46	Rovere sbiancato <i>Whitened durmast</i>

Le caratteristiche tecniche degli articoli potranno subire variazioni senza preavviso ed obbligo di comunicazione, secondo le nostre esigenze di fabbricazione e per il perfezionamento degli apparecchi.

*The technical specifications of all products can be altered immediately without prior notice in order to comply with our manufacturing requirements and to improve the specification of the products*



## IP

Protezione contro la penetrazione di corpi solidi. *Protection against penetration of solid object.*

Grado di protezione.  
*Protection degree.*

1° cifra <i>1st numeral</i>	Descrizione <i>Description</i>	Simbolo <i>Symbol</i>
0	Non protetto / <i>Non-protected</i>	
1	Protetto da solidi di diametro superiore a 50 mm <i>Protected against solid objects up to than 50 mm</i>	
2	Protetto da solidi di diametro superiore a 12 mm <i>Protected against solid objects up to than 12 mm</i>	
3	Protetto da penetrazione di sonda con Ø2,5 mm <i>Protected against solid objects with Ø 2,5 mm</i>	
4	Protetto da penetrazione di sonda con Ø1 mm <i>Protected against solid objects with Ø 1 mm</i>	
5	Protetto dall'ingresso della polvere / <i>Dust-protected</i>	⬢
6	Stagno alla polvere / <i>Dust-tight</i>	⬢

Protezione contro la penetrazione di liquidi. *Protection against penetration of water.*

2° cifra <i>2nd numeral</i>	Descrizione <i>Description</i>	Simbolo <i>Symbol</i>
0	Non protetto / <i>Non-protected</i>	
1	Protetto da caduta verticale di gocce d'acqua / <i>Protected against dripping water</i>	⬇
2	Protetto da caduta di gocce d'acqua con involucro inclinato max di 15° <i>Protected against dripping water when tilted up to 15°</i>	
3	Protetto da pioggia / <i>Protected against spraying water</i>	☐
4	Protetto dagli spruzzi d'acqua / <i>Protected against splashing</i>	⚠
5	Protetto dai getti d'acqua / <i>Protected against water jets</i>	
6	Protetto dalle ondate / <i>Protected against heavy seas</i>	⚠
7	Stagno alle immersioni / <i>Protected against the effects of immersion</i>	⬇
8	Stagno alla sommersione / <i>Protected against submersion</i>	⬇ m

## CLASSE / CLASS

Grado di protezione contro la scossa elettrica / *Degree of protection against electric shocks.*

Classe <i>Class</i>	Descrizione <i>Description</i>	Simbolo <i>Symbol</i>
0	La protezione si basa sull'isolamento fondamentale. Non è previsto il conduttore di protezione (massa a terra). <i>Protection is achieved by simple insulation, there is no earth cable provided.</i>	Nessun simbolo <i>No symbol</i>
I	La protezione si basa sull'isolamento fondamentale e sul collegamento delle pareti metalliche accessibili ad un conduttore di protezione (massa a terra). <i>The protection is achieved by simple insulation and connection of all metallic components to an earth wire protection cable.</i>	Nessun simbolo <i>No symbol</i>
II	La protezione si basa sull'isolamento fondamentale e su misure supplementari quali il doppio isolamento rinforzato. <i>Protection is achieved by simple insulation and some other devices such as double insulation or reinforced insulation. There is no earth cable provided.</i>	☐
III	La protezione si basa sul fatto che in ogni punto dell'apparecchio la tensione di alimentazione e/o di funzionamento è inferiore a 50V valore efficace in C.A. (bassissima tensione di sicurezza). <i>Protection is achieved by every component of the luminaire having a start/functioning voltage of less than 50 VA (safety Extra Low Voltage SELV).</i>	⚡

## IK

Protezione contro gli impatti meccanici esterni. *Protection against external mechanical impacts.*

Grado di protezione.  
*Protection degree.*

Cifra carattere <i>Numeral</i>	Descrizione <i>Description</i>
00	Non protetto / <i>Non-protected</i>
01	Protetto contro un urto di energia 0,15 J / <i>Protected against impact energy 0,15 J</i>
02	Protetto contro un urto di energia 0,2 J / <i>Protected against impact energy 0,2 J</i>
03	Protetto contro un urto di energia 0,35 J / <i>Protected against impact energy 0,35 J</i>
04	Protetto contro un urto di energia 0,5 J / <i>Protected against impact energy 0,5 J</i>
05	Protetto contro un urto di energia 0,7 J / <i>Protected against impact energy 0,7 J</i>
06	Protetto contro un urto di energia 1 J / <i>Protected against impact energy 1 J</i>
07	Protetto contro un urto di energia 2 J / <i>Protected against impact energy 2 J</i>
08	Protetto contro un urto di energia 5 J / <i>Protected against impact energy 5 J</i>
09	Protetto contro un urto di energia 10 J / <i>Protected against impact energy 10 J</i>
10	Protetto contro un urto di energia 20 J / <i>Protected against impact energy 20 J</i>

## DRIVER

Driver in tensione continua.  
*Driver Vdc.*

	Codice <i>Code</i>	W	IP	Dimensioni <i>Dimensions</i> (LxWxH)	€ (IVA esclusa) <i>(VAT excluded)</i>	
12Vdc	0700	4	40	52x27x21 mm	18,00	
	0730	20	67	118x35x26 mm	26,00	
	0731	35	67	148x40x30 mm	38,00	
	0732	60	67	163x43x32 mm	45,00	
	24Vdc	0733	100	67	190x52x37 mm	74,00
		0734	150	67	191x67x38 mm	120,00
0735		185	67	229x68x39 mm	180,00	
24Vdc DIMM	0736	240	67	251x68x39 mm	200,00	
	0731/DIMM 2-3	35	20	195x43x30 mm	96,00	
	0732/DIMM 2-3	60	20	225x43x30 mm	116,00	
	0733/DIMM 2-3	100	20	295x43x30 mm	144,00	
	0734/DIMM 2-3	150	20	325x43x30 mm	184,00	

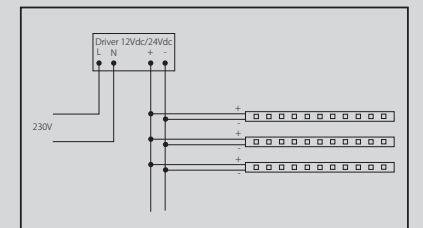

## EMERGENZA: INVERTER E BATTERIE PER LED / EMERGENCY: LED INVERTERS AND BATTERIES

Codice Code			€ (IVA esclusa) / (VAT excluded)
0800/EM	Max 30W	Output 9-58V	125,00

Unità d'emergenza ad uso indipendente multipotenza regolabile tramite dip-switch, per power LED a corrente costante o per moduli LED a tensione costante.

Possibilità di funzionamento in sola emergenza (SE) o tipo SA in abbinamento ad un driver con tensione in uscita max 90V e corrente max 2A.

Autonomia 1h.

Dimensioni: inverter mm 52x156xh26; batterie mm 135x45xh25.

Avvertenze:  
PER NON DANNEGGIARE I LED COLLEGARE NELL'ORDINE:  
1) SORGENTE LED;  
2) CAVO BATTERIA;  
3) ALIMENTAZIONE DI RETE.  
NON SCOLLEGARE E RICOLLEGARE I LED CON EMERGENZA IN FUNZIONE.

*Multi-voltage emergency unit to be used independently. Adjustable by dip-switch. For constant current power LEDs or for constant voltage LED modules.*

*Can be used in either emergency only (SE) mode or SA (always on) mode, combined with a driver with maximum 90V output voltage and maximum 2A current.*

*Autonomy 1 hour.*

*Dimensions: inverters 52mm x 156mm x h26mm; batteries 135mm x 45mm x h25mm*

*Warning:  
TO AVOID DAMAGING LEDS CONNECT THEM IN THE FOLLOWING ORDER:  
1) LED SOURCE;  
2) BATTERY CABLE;  
3) GRID POWER SUPPLY.  
DO NOT DISCONNECT AND RECONNECT LEDS IN EMERGENCY MODE.*

## DIMMER PER DRIVER LED 24Vdc / DIMMER FOR 24Vdc DRIVER

Codice Code			€ (IVA esclusa) / (VAT excluded)
0800/DIM	Max 250W		88,00

Regolatore di luminosità per driver LED in tensione 12Vdc-24Vdc.  
Modalità di funzionamento DALI, Push, 1-10V, 0-10V.  
La modalità di funzionamento è selezionata attraverso DIP SWITCH.

Tensione di alimentazione: 12Vdc - 24Vdc  
Corrente massima di uscita: 12A.  
Dimensioni DIMM: 156x52xh26mm

*Light regulator for 12Vdc-24Vdc LED driver.  
DALI, Push, 1-10V, 0-10V mode of operation.  
Mode of operation selection by DIP SWITCH.*

*Voltage: 12Vdc - 24Vdc  
Maximum current output: 12A.  
Dimensions: 156x52xh26 mm*

## DRIVER - CORRENTE CONTINUA NON DIMMERABILI IP20 / DRIVER - DIRECT CURRENT NOT DIMMABLE IP20

Codice Code	Potenza Wattage	Corrente Currente	Tensione (min-max) Voltage	€ (IVA esclusa) / (VAT excluded)
0310.10CC350	10W	350mA	13-26V	13,00
0310.20CC350	20W	350mA	26-57V	15,00
0310.35CC350	35W	350mA	50-100V	35,00

0310.10CC500	10W	500mA	9-20V	15,00
0310.20CC500	20W	500mA	18-40V	25,00
0310.35CC500	35W	500mA	35-70V	25,00

0310.10CC700	10W	700mA	6,5-14,5V	22,00
0310.20CC700	20W	700mA	13-29V	22,00
0310.30CC700	30W	700mA	32-40V	25,00

0310.42CC900	42W	900mA	23-47V	27,00
--------------	-----	-------	--------	-------

0310.35CC1050	35W	1050mA	16,5-33,5V	28,00
0310.42CC1050	42W	1050mA	20-40V	28,00
0310.60CC1050	60W	1050mA	31-57V	43,00

0310.65CC1400	65W	1400mA	23-46,5V	60,00
---------------	-----	--------	----------	-------

Avvertenze:

- Prima di acquistare un driver in corrente continua, onde evitare malfunzionamenti o danni irreparabili alle sorgenti a LED, è necessario verificare che la tensione nominale del LED utilizzato (se più LED collegati in serie la loro somma) sia compresa nel range dei valori di tensione del driver;

- Collegamenti: dare tensione solo dopo aver cablato correttamente il LED ai morsetti polarizzati (+-) del driver, in quanto il picco di tensione in uscita di un driver c.c. senza carico è maggiore del valore massimo riportato nei relativi dati. Per evitare danni alle sorgenti luminose, non collegare mai un LED ad un driver c.c. alimentato.

Per eventuali richieste di driver dimmerabili, contattare i nostri uffici commerciali.

Warning:

- Before purchasing a direct current driver, in order to avoid malfunctioning or irreparable damage to LED sources, you must check that the nominal voltage of the LED used (in the case of a series of connected LEDs then calculate their sum) is within the range of the rated voltage of the driver.

- Connections: apply power only after correctly cabling the LED to the polarised (+ -) terminals of the driver as the peak of output voltage of an uncharged direct current driver is greater than the maximum value stated in the relative specifications. To avoid damaging light sources, never mount a LED on a powered direct current driver.

If you require dimmerable drivers contact our sales office.

## DIMM2

Dali  
Dali

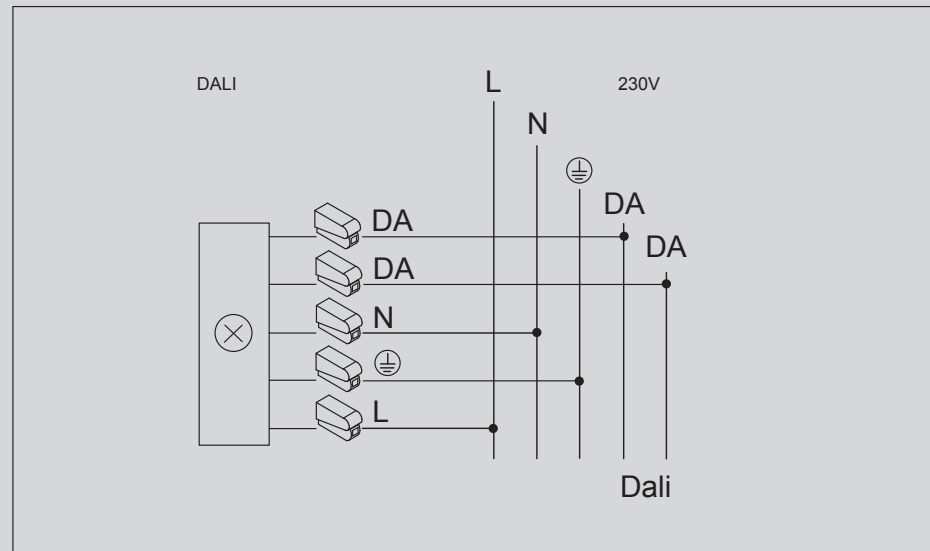

Digitale (Versione dimmerabile con protocollo DALI).  
Digital (Dimmer version with DALI protocol).

### Gestione digitale DALI.

Il protocollo DALI (Digital Addressable Lighting Interface) è uno standard per alimentatori elettronici dimmerabili che offre funzionalità e facilità d'uso. Con una linea di controllo a due fili è possibile controllare con un'elevata versatilità 64 alimentatori elettronici DALI, assegnare 16 gruppi e programmare sino a 16 scenari luminosi. La commutazione e il dimming sono gestiti dalla linea di controllo e non necessita di relè. Le informazioni importanti come lo stato delle lampade sono memorizzate nell'alimentatore e restano a disposizione del controller. Un nuovo conferimento dei gruppi può essere realizzato in qualsiasi momento senza la necessità di effettuare nuovi cablaggi costosi, ad esempio a seguito di un restauro o un cambiamento di utilizzo di un locale. Riassumendo, progettare ed installare un impianto DALI significa avere un'unica linea di controllo a due cavi per 64 apparecchi. I gruppi degli apparecchi d'illuminazione non devono essere necessariamente assegnati in fase di progettazione ma possono essere configurati successivamente con l'ausilio di un controller. La progettazione della linea dimming può essere di conseguenza completamente separata dalla progettazione delle linee di alimentazione. La linea di controllo non ha polarità e può essere posata insieme all'alimentazione, ad esempio in un cavo a 5 fili. È sufficiente che la linea di controllo sia dimensionata per la tensione della linea e non è necessario un cablaggio speciale. I gruppi degli apparecchi d'illuminazione non sono collegati direttamente; i singoli apparecchi vengono raggruppati semplicemente assegnandoli a gruppi con l'ausilio di un controller.

### Digital control DALI.

*The DALI (Digital Addressable Lighting Interface) is a protocol for dimmable electronic ballast which is functional and easy to use. With a two-wire differential bus you can handily control 64 DALI electronic ballasts, assign up to 16 groups and programme up to 16 lighting scenarios. Commutation and dimming are handled by the control wire and do not require a relay. Important information such as the state of the lamps is memorised in the ballast and is constantly accessible to the controller. Groups can be differently assigned at any time without the need for any costly new wiring, for instance following a home renovation. In short designing and installing a DALI plant means having a single control wire with a two-wire bus for up to 64 devices. The groups of lighting fixtures do not necessarily have to be assigned during the planning phase but can be configured later with the aid of a controller. The design of the dimming wire can consequently be completely separate from the power cable design. The control wire is non-polarised and can be routed together with the ballast, for example in a 5 conductor cable. The control wire only needs to be adjusted for mains voltage and does not necessitate special wiring. The groups of lighting fixtures are not connected directly. Individual fixtures are grouped simply by assigning them to groups with the aid of a controller.*

## DIMM3

Switch-DIM  
Switch-DIM

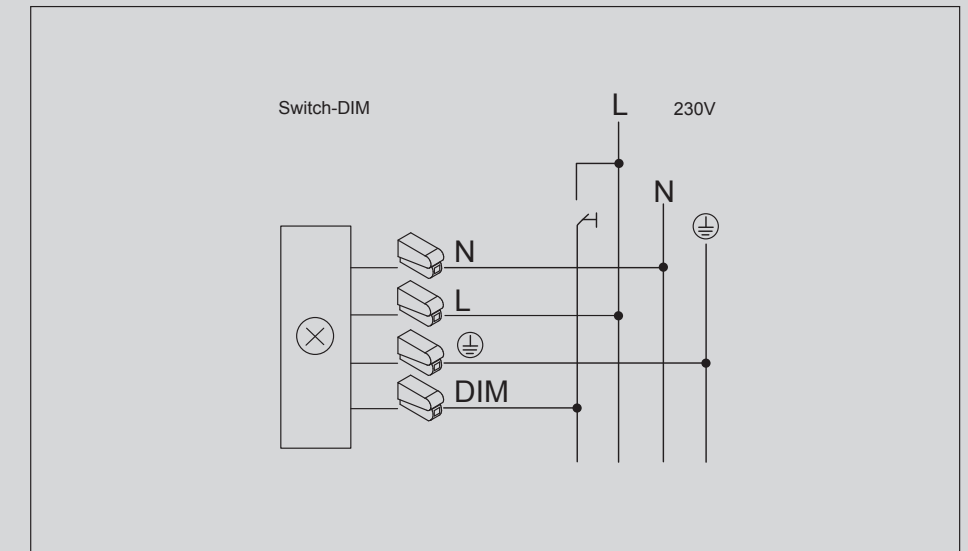

Digitale (Versione dimmerabile tramite un semplice pulsante con contatti normalmente aperti switch/dim).  
Digital (Dimmer version with switch/dim).

### Gestione digitale switchDim.

Le applicazioni switchDIM utilizzano la tensione di rete come segnale di regolazione per alimentatori digitali dimmerabili. Rappresentano la forma più semplice di gestione del flusso luminoso per le piccole e medie installazioni e rendono la tecnologia switchDIM estremamente semplice, dall'ottimo rapporto qualità/prezzo e dal facile uso. La dimmerazione, così pure l'accensione e lo spegnimento del sistema luminoso, possono essere effettuati da svariati punti semplicemente utilizzando pulsanti N/A commerciali convenzionali, collegati alla tensione di rete. I reattori elettronici utilizzati da Aqlus sono dotati di memoria e mantengono l'ultimo valore di luminosità selezionato anche in caso di interruzione di rete. Modalità d'uso: l'accensione e lo spegnimento dell'apparecchio è effettuato tramite rapida pressione del pulsante, mentre per la regolazione up/down del flusso luminoso si rende necessaria una pressione prolungata. Un pulsante può comandare sino a 20 alimentatori elettronici (contattare i nostri uffici per maggiori dettagli). In caso di perdita del sincronismo tra le varie lampade, gli apparecchi potranno essere nuovamente sincronizzati tenendo premuto il pulsante che le comanda, per una decina di secondi.

### SwitchDIM digital control.

*SwitchDIM applications use mains voltage as a control signal for digital dimmable ballasts. They are the simplest way of controlling brightness in small and medium sized installations and make switchDim technology extremely simple and user-friendly with an excellent quality/price ratio. Dimming, like switching the light on and off, can be done from various points simply by using conventional commercial N/A switches connected with mains voltage. The ballasts used by Aqlus are equipped with a memory and memorise the last brightness value selected even in the case of a power cut. Instructions for use: the fixture is switched on and off by rapidly pushing the button while fade up/down control requires the button to be held down for a longer time. A switch-dim can control up to 20 electronic ballasts (for more informations contact our offices). In case of loss of synchronism between different lamps the fixtures can again be synchronised by keeping the button held down for approximately ten seconds.*

## EM

Emergenza  
Emergency

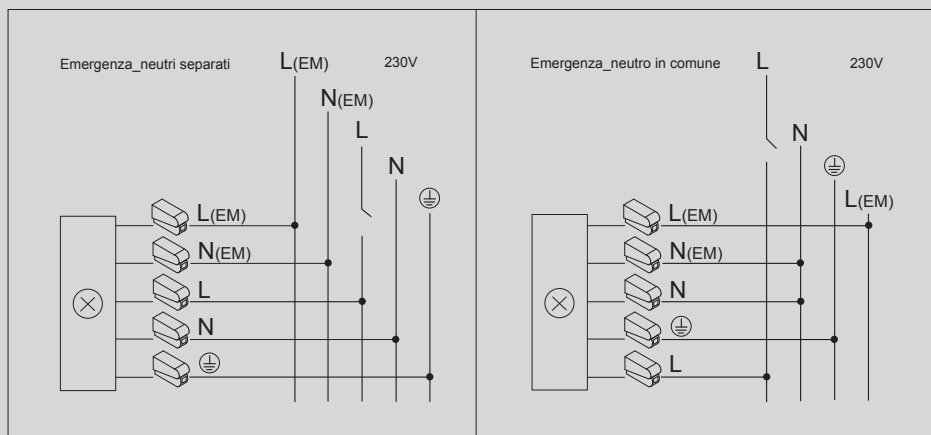

Versioni emergenza complete di inverter e gruppo batterie; luce permanente, autonomia 1 ora.  
Emergency versions complete with an inverter and a battery unit; permanent light, autonomy 1 hour.

## Funzionamento in emergenza

Le lampade di emergenza forniscono un'illuminazione fondamentale quando vi è un'improvvisa mancanza d'erogazione dell'energia elettrica a seguito di guasti, sgancio imprevisto degli interruttori automatici di protezione ed in caso di situazioni di pericolo. Lo scopo è assicurare un adeguato grado di illuminamento in modo da garantire le operazioni in tutte le situazioni di rischio. L'illuminazione di emergenza è quindi, soprattutto nelle situazioni più gravi, una componente fondamentale per la sicurezza delle persone. I luoghi che devono essere obbligatoriamente dotati di illuminazione di emergenza sono indicati dalle varie normative e dai DM vigenti. L'uso è prescritto per tutti i luoghi solitamente affollati come ospedali, scuole, luoghi di lavoro, cinema ecc...

Da non sottovalutare inoltre anche l'ambito domestico, dove l'illuminazione di emergenza può assumere un ruolo fondamentale per la sicurezza delle persone. Per scegliere correttamente le lampade di emergenza è necessaria la conoscenza delle varie tipologie e caratteristiche fondamentali dei vari tipi di funzionamento. Tutti gli apparecchi Aqlus dotati di inverter e batteria sono di tipo SA (funzionamento permanente) e cioè la lampada rimane costantemente accesa sia in presenza che in assenza di rete; questo tipo di funzionamento è normalmente richiesto per l'illuminazione delle vie di esodo. Inoltre questa tipologia è comunemente utilizzata nei locali dove non è possibile aggiungere ulteriori punti luce. Infatti, con un unico apparecchio si gestisce sia l'illuminazione ordinaria (on/off) che quella di emergenza.

Le altre tipologie esistenti sono:

- Apparecchi non permanenti di tipo SE: la lampada si accende solo quando c'è un'interruzione dell'energia elettrica.
- Modelli SL: gli apparecchi non sono dotati di pacchi batterie e di inverter ma soltanto dell'alimentatore/driver per l'accensione della sorgente luminosa. Possono essere alimentati da una tensione di 230Vac ed utilizzati come funzionamento ordinario, oppure possono essere collegate ad impianti di emergenza con soccorritore centralizzato.

L'autonomia minima garantita dei prodotti in emergenza forniti da Biffi Luce è pari a 1h di funzionamento ma a richiesta (ove è possibile) possono essere prodotti con un'autonomia di 2h o 3h.

## Emergency lighting

Emergency lighting provides basic lighting when there is a sudden blackout due to electrical failure or tripped switches and in situations of danger. Its purpose is to guarantee a sufficient degree of illumination so as to ensure operations in all cases of risk. Emergency lighting is, therefore, above all in the most serious situations, a fundamental safety component. Places which must be provided with emergency lighting are listed in the various regulations and laws in force. Its use is mandatory in all normally crowded environments such as hospitals, schools, workplaces, cinemas etc... Moreover, the home, where emergency lighting may be key to peoples' safety, should not be overlooked.

In order to choose the correct types of emergency lighting it is necessary to know them and understand how they work.

All Aqlus fixtures equipped with an inverter and battery are SA type (providing permanent lighting) meaning that the light stays on whether or not it is connected to the mains. Lighting with this feature is normally used to light emergency exits. Moreover, this type is usually found in places where it is not possible to add any more light sources. Indeed, just one fixture provides ordinary (on/off) and emergency lighting.

Other existing types are:

- Non-permanent SE type fixtures: the light only goes on when there is an outage.
- SL models: the fixtures are not supplied with battery packs and inverters but only with a ballast/driver to drive the light source. They may be charged with a voltage of 230V ac and used as ordinary lighting or connected to emergency central power supply systems.

Minimum operating time guaranteed by emergency products supplied by Biffi Luce is 1 hour but products with 2 or 3 hour operating time can also be ordered (if available).

## SICUREZZA FOTOBIOLOGICA / PHOTOBIOLOGICAL SAFETY (RG)

### Sicurezza fotobiologica della lampade e dei sistemi per l'illuminazione generale dei dispositivi a LED.

Siamo passati dalle lampade ad incandescenza, ormai obsolete e sostituite dalle lampadine alogene e fluorescenti, per arrivare alle nuove tecnologie LED; questo sviluppo ha inevitabilmente portato alla nascita di numerose nuove normative. La nuova norma IEC/EN 62471 "Sicurezza fotobiologica delle lampade e dei sistemi di lampada" fornisce le linee guida per la valutazione e il controllo dei rischi fotobiologici, specificando le grandezze radiometriche da misurare per valutare i rischi per la pelle e l'occhio umano derivanti dall'esposizione alla luce emessa dagli apparecchi di illuminazione che utilizzano la tecnologia LED. I valori limite sono calcolati in base al tempo di esposizione; nel caso degli apparecchi d'illuminazione, a meno che il compito lavorativo non preveda di fissare la sorgente luminosa, la visione è casuale ed avviene normalmente in maniera accidentale. La versione Europea è armonizzata ai sensi della direttiva 2006/95/CE – Bassa Tensione, di conseguenza, i prodotti elettrici che incorporano LED e che rientrano nel campo di applicazione della Direttiva Bassa Tensione devono soddisfare i requisiti indicati dalla norma EN 62471. Questa Norma classifica in base al grado di pericolosità della radiazione, gli apparecchi di illuminazione in quattro "gruppi di rischio" (assenza/basso/moderato/alto). Sotto riportiamo la tabella riassuntiva di classificazione del rischio fotobiologico delle lampade secondo lo standard CEI EN 62471:2009.

### Photobiological safety of lamps and lamp system.

We have passed from incandescent lamps, now obsolete and replaced by halogen and fluorescent lamps, to new LED technologies. This advancement has inevitably led to the emergence of numerous further standards. The new IEC/EN 62471 "Photobiological safety of lamps and lamp systems" standard lays down guidelines for the evaluation and control of photobiological hazards, specifying the types of radiant energy to be measured in order to evaluate the risk to human skin and eyes posed by exposure to light emitted by lighting appliances using LED technologies. Limit values are calculated on the basis of exposure time. In the case of lighting appliances, if the task to be performed does not demand a fixed light source, the vision is random and normally accidental. The European standard is set pursuant to and in accordance with Low Voltage Directive 2006/95/CE. Consequently, electrical products incorporating LED and to which the Low Voltage Directive applies must conform to requirements specified in standard EN 62471. This standard divides lighting appliances into four "risk groups" (exempt/low/moderate/high) based on the degree of radiation hazard. Below is a table summarising the photobiological risk classification of lamps in accordance with standard CEI EN 62471:2009.

Gruppo Group	Descrizione Description
0 (esente/exempt)	Quando non si prevede nessun rischio ottico, anche per un uso continuo e illimitato. Where no optical hazard is considered foreseeable, even for continuous, unrestricted use.
1	Prodotti che sono sicuri per la maggior parte delle applicazioni di utilizzo, fatta eccezione per esposizioni molto prolungate dove possono essere previste esposizioni oculari dirette. Products are safe for most use applications, except for very prolonged exposures where direct ocular exposures may be expected.
2	Prodotti che generalmente non rappresentano un rischio ottico realistico se le reazioni di avversione limitano la durata dell'esposizione o quando esposizioni lunghe non sono realistiche. Products generally do not pose a realistic optical hazard if aversion responses limit the exposure duration or where lengthy exposures are unrealistic.
3	Prodotti che presentano un potenziale pericolo anche per esposizioni momentanee e quando i requisiti di sicurezza del sistema sono essenziali. Products pose a potential hazard even for momentary exposures and system safety requirements are generally essential.

## APPLICAZIONI A BINARIO / TRACK INSTALLATION

### Installazione porta peso.

Il binario può portare un carico di 2 kg ogni 200 mm con una distanza massima fra i punti di fissaggio di 1000 mm. Nel caso di 5 kg ogni 200 mm la distanza di fissaggio deve essere di 500 mm.

### Installation weights.

The track can support a weight of 2 kg every 200 mm with maximum unconnected fixing centres of 1000 mm. When this rises to 5 kg every 200 mm, the fixing centres must be decreased to 500 mm.

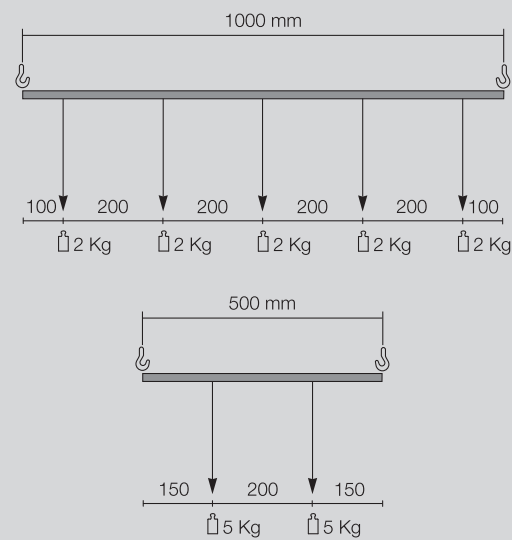

### Schema elettrico trifase.

Tensione di esercizio 230/250 V tra una fase e il neutro. Il collegamento della rete elettrica trifase 230/250 V consente un carico di 16A per fase che corrisponde 3680 VA per ogni circuito.

### Three-phase electrical diagram.

Supply voltage 230/250 V. Connection to three phase 230/250 V electrical supply enables a total load of 16 amps to be used which corresponds to 11040 VA spread over three circuits (3x3680 VA).

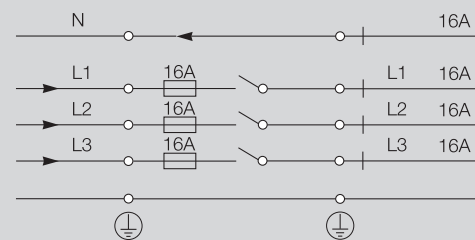

## CURVE 90° PER I SISTEMI FUSION, LINE E MINILINE / 90° CORNERS FOR THE SYSTEMS FUSION, LINE AND MINILINE

### Esempi di combinazione per curva 90° (vista in pianta)

### Examples of combinations for a 90° corner (top view)

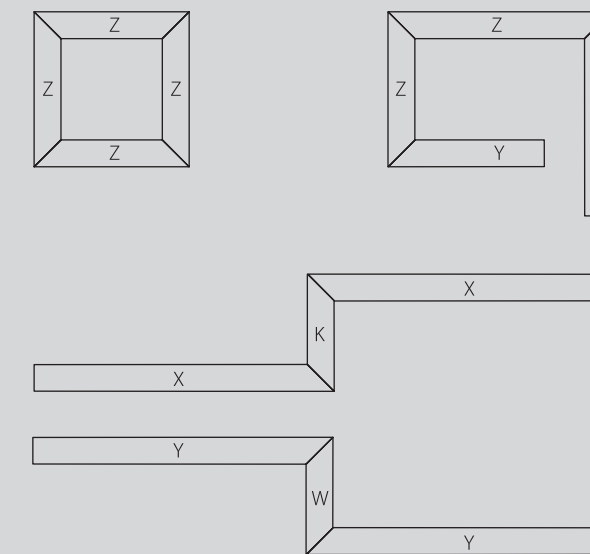

### Codifica in fase di ordine

In fase di ordine del prodotto occorre inserire alla fine del codice la lettera corrispondente alla curva che si desidera ottenere.

### Order code

When ordering the product the letter corresponding to the desired curve must be added to the end of the code.

### Esempio MINILINE (vista in pianta) / Example MINILINE (top view)

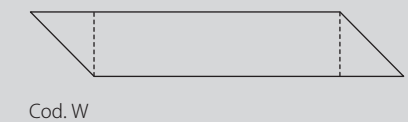
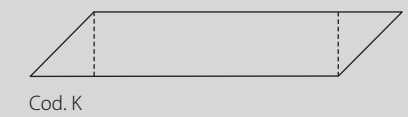
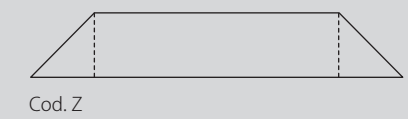
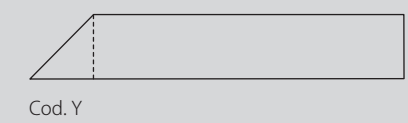
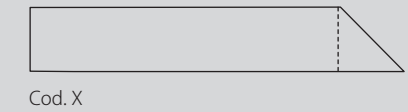
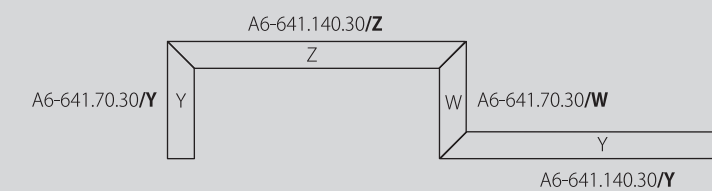

A richiesta altre tipologie di curva  
Customized corner on request





CODICE	€ (IVA esclusa) / (VAT excluded)	P.	CODICE	€ (IVA esclusa) / (VAT excluded)	P.	CODICE	€ (IVA esclusa) / (VAT excluded)	P.
0310.10CC350	13,00	151	6915	1,40	60	A2-610.08AC.40	118,00	41
0310.10CC500	15,00	151	6916	3,60	60	A2-610.08AC.40/D	118,00	40
0310.10CC700	22,00	151	6917	7,00	60	A2-612.15AC.30	170,00	43
0310.20CC350	15,00	151	6918	5,80	60	A2-612.15AC.30/D	170,00	42
0310.20CC500	25,00	151				A2-612.15AC.40	170,00	43
0310.20CC700	22,00	151	A1			A2-612.15AC.40/D	170,00	42
0310.30CC700	25,00	151	A1-100	260,00	138	A2-612.17.30/D	199,00	42
0310.35CC1050	28,00	151	A1-606.30	180,00	138	A2-612.17.40/D	199,00	42
0310.35CC350	35,00	151	A1-606.40	180,00	138	A2-612.22.30/D	199,00	42
0310.35CC500	25,00	151	A1-607.09.30	220,00	139	A2-612.22.40/D	199,00	42
0310.42CC1050	28,00	151	A1-607.09.40	220,00	139	A2-612.31.30/D	199,00	42
0310.42CC900	27,00	151	A1-608.03.30	78,00	139	A2-612.31.40/D	199,00	42
0310.60CC1050	43,00	151	A1-608.03.40	78,00	139	A2-628.17.30/D	180,00	53
0310.65CC1400	60,00	151	A1-620.04.30	115,00	142	A2-628.17.40/D	180,00	53
0500	15,00	142	A1-620.04.40	115,00	142	A2-628.23.30/D	188,00	53
0506.1	14,00	88	A1-655.1.30	45,00	143	A2-628.23.40/D	188,00	53
0700	18,00	149	A1-655.1.40	45,00	143	A2-629.20AC.30	135,00	52
07-010	50,00	135	A1-655.2.30	45,00	143	A2-629.20AC.30/D	135,00	52
0730	26,00	135-149	A1-655.2.40	45,00	143	A2-629.20AC.40	135,00	52
0731	38,00	135-149				A2-629.20AC.40/D	135,00	52
0731/DIMM2-3	96,00	135-149	A2			A2-629.30AC.30	145,00	52
0732	45,00	135-149	A2-207.30/D	190,00	46	A2-629.30AC.30/D	145,00	52
0732/DIMM2-3	116,00	135-149	A2-207.40/D	190,00	46	A2-629.30AC.40	145,00	52
0733	74,00	135-149	A2-209.30	150,00	44	A2-629.30AC.40/D	145,00	52
0733/DIMM2-3	144,00	135-149	A2-209.30/D	170,00	44	A2-640.18.30	155,00	56
0734	120,00	135-149	A2-209.40	150,00	44	A2-640.18.40	155,00	56
0734/DIMM2-3	184,00	135-149	A2-209.40/D	170,00	44	A2-642.25.30	159,00	56
0735	180,00	135-149	A2-604.15AC.30/D	160,00	59	A2-642.25.40	159,00	56
0736	200,00	135-149	A2-604.15AC.40/D	160,00	59	A2-642.30AC.30	149,00	56
		111-124	A2-606.15.30	170,00	49	A2-642.30AC.40	149,00	56
0800/DIM	88,00	128-131	A2-606.15.30/D	170,00	51	A2-642.34.30	173,00	56
		132-133	A2-606.15.40	170,00	49	A2-642.34.40	173,00	56
		150	A2-606.15.40/D	170,00	51	A2-642.38.30	180,00	56
0800/EM	125,00	111-124	A2-606.17.30/D	168,00	49	A2-642.38.40	180,00	56
		128-131	A2-606.17.40/D	168,00	49	A2-644.38.30	180,00	57
		132-133	A2-606.23.30/D	178,00	49	A2-644.38.40	180,00	57
		150	A2-606.23.40/D	178,00	49	A2-644.40AC.30	160,00	57
6901	35,00	60	A2-607.08AC.30	170,00	46	A2-644.40AC.40	160,00	57
6902	68,00	60	A2-607.08AC.30/D	170,00	50	A2-644.44.30	185,00	57
6903	101,00	60	A2-607.08AC.40	170,00	46	A2-644.44.40	185,00	57
6904	13,00	60	A2-607.08AC.40/D	170,00	50	A2-644.46.30	195,00	57
6905	13,00	60	A2-608.17.30	190,00	58	A2-644.46.40	195,00	57
6906	8,60	60	A2-608.17.30/D	190,00	59			
6907	5,60	60	A2-608.17.40	190,00	58	A3		
6908	34,40	60	A2-608.17.40/D	190,00	59	A3-400.30	730,00	22
6909	29,00	60	A2-609.12.30/D	169,00	40	A3-400.40	730,00	22
6910	29,00	60	A2-609.12.40/D	169,00	40			
6911	43,00	60	A2-610.08AC.30	118,00	41	A4		
6912	43,00	60	A2-610.08AC.30/D	118,00	40	A4-202.2.30	345,00	18
6913	58,00	60						
6914	25,50	60						

CODICE	€ (IVA esclusa) / (VAT excluded)	P.	CODICE	€ (IVA esclusa) / (VAT excluded)	P.	CODICE	€ (IVA esclusa) / (VAT excluded)	P.
A4-202.2.40	345,00	18	A5-606.07.30/DIMM 2-3	128,00	79	A5-663.22.30/DIMM 2-3	200,00	70
A4-203.4.30	550,00	19	A5-606.07.40	88,00	79	A5-663.28.30	170,00	70
A4-203.4.40	550,00	19	A5-606.07.40/DIMM 2-3	128,00	79	A5-663.28.30/DIMM 2-3	200,00	70
A4-600.212.30	330,00	18	A5-606.10.30	88,00	79	A5-663.33.30	180,00	70
A4-600.212.40	330,00	18	A5-606.10.30/DIMM 2-3	128,00	79	A5-663.33.30/DIMM 2-3	210,00	70
A4-600.217.30	340,00	18	A5-606.10.40	88,00	79	A5-664.22.30	170,00	70
A4-600.217.40	340,00	18	A5-606.10.40/DIMM 2-3	128,00	79	A5-664.22.30/DIMM 2-3	200,00	70
A4-600.223.30	360,00	18	A5-620.026.30	210,00	68	A5-664.28.30	170,00	70
A4-600.223.40	360,00	18	A5-620.026.30/DIMM 2-3	260,00	68	A5-664.28.30/DIMM 2-3	200,00	70
A4-602.412.30	495,00	19	A5-620.026.30/EM	350,00	68	A5-664.33.30	180,00	70
A4-602.412.40	495,00	19	A5-620.026.40	210,00	68	A5-664.33.30/DIMM 2-3	210,00	70
A4-602.417.30	520,00	19	A5-620.026.40/DIMM 2-3	260,00	68	A5-665.07.30	69,00	72
A4-602.417.40	520,00	19	A5-620.026.40/EM	350,00	68	A5-665.07.30/DIMM 2-3	99,00	72
A4-602.423.30	550,00	19	A5-621.026.30	210,00	68	A5-665.10.30	69,00	72
A4-602.423.40	550,00	19	A5-621.026.30/DIMM 2-3	260,00	68	A5-665.10.30/DIMM 2-3	99,00	72
A4-613.30	180,00	16	A5-621.026.30/EM	350,00	68	A5-666.07.30	69,00	72
A4-613.40	180,00	16	A5-621.026.40	210,00	68	A5-666.07.30/DIMM 2-3	99,00	72
A4-630.036.30	450,00	22	A5-621.026.40/DIMM 2-3	260,00	68	A5-666.10.30	69,00	72
A4-630.036.30/DIMM 2-3	490,00	22	A5-621.026.40/EM	350,00	68	A5-666.10.30/DIMM 2-3	99,00	72
A4-630.036.40	450,00	22	A5-628.17.30	180,00	53	A5-668.11.30	85,00	74
A4-630.036.40/DIMM 2-3	490,00	22	A5-628.17.30/DIMM 2-3	220,00	53	A5-668.11.30/DIMM 2-3	125,00	74
A4-631.048.30	520,00	22	A5-628.17.40	180,00	53	A5-669.25.30	135,00	74
A4-631.048.30/DIMM 2-3	580,00	22	A5-628.17.40/DIMM 2-3	220,00	53	A5-669.25.30/DIMM 2-3	180,00	74
A4-631.048.40	520,00	22	A5-628.24.30	188,00	53	A5-670.07.30	69,00	73
A4-631.048.40/DIMM 2-3	580,00	22	A5-628.24.30/DIMM 2-3	228,00	53	A5-670.07.30/DIMM 2-3	99,00	73
A4-640.13.30	235,00	8	A5-628.24.40	188,00	53	A5-670.10.30	69,00	73
A4-640.13.40	235,00	8	A5-628.24.40/DIMM 2-3	228,00	53	A5-670.10.30/DIMM 2-3	99,00	73
A4-641.15.30	250,00	8	A5-629.10.30	90,00	76	A5-672.30	390,00	65
A4-641.15.40	250,00	8	A5-629.10.30/DIMM 2-3	130,00	76	A5-672.30/DIMM 2-3	430,00	65
A4-641.20.30	260,00	8	A5-632.08AC.30	94,00	82	A5-672.30/EM	530,00	65
A4-641.20.40	260,00	8	A5-632.08AC.40	94,00	82	A5-672.40	390,00	65
A4-645.25.30	260,00	8	A5-650.30	36,00	88	A5-672.40/DIMM 2-3	430,00	65
A4-645.25.40	260,00	8	A5-650.60	36,00	88	A5-672.40/EM	530,00	65
A4-646.35.30	270,00	8	A5-651.30	66,00	88	A5-673.70.30	690,00	65
A4-646.35.40	270,00	8	A5-655.30	48,00	90	A5-673.70.30/DIMM 2-3	730,00	65
A4-650.15.30	169,00	13	A5-656.30	48,00	90	A5-673.70.30/EM	830,00	65
			A5-662.22.30	135,00	69	A5-673.70.40	690,00	65
A5			A5-662.22.30/DIMM 2-3	175,00	69	A5-673.70.40/DIMM 2-3	730,00	65
A5-600.03.30	74,00	89	A5-662.22.40	135,00	69	A5-673.70.40/EM	830,00	65
A5-601.03.30	74,00	89	A5-662.22.40/DIMM 2-3	175,00	69	A5-675.10.30	79,00	76
A5-605.07.30	88,00	78	A5-662.28.30	140,00	69	A5-675.10.30/DIMM 2-3	119,00	76
A5-605.07.30/DIMM 2-3	128,00	78	A5-662.28.30/DIMM 2-3	190,00	69	A5-676.15.30	89,00	77
A5-605.07.40	88,00	78	A5-662.28.40	140,00	69	A5-676.15.30/DIMM 2-3	129,00	77
A5-605.07.40/DIMM 2-3	128,00	78	A5-662.28.40/DIMM 2-3	190,00	69	A5-677.07.30	70,00	82
A5-605.10.30	88,00	78	A5-662.33.30	155,00	69	A5-677.07.30/DIMM 2-3	110,00	82
A5-605.10.30/DIMM 2-3	128,00	78	A5-662.33.30/DIMM 2-3	200,00	69	A5-677.12.30	74,00	82
A5-605.10.40	88,00	78	A5-662.33.40	155,00	69	A5-677.12.30/DIMM 2-3	114,00	82
A5-605.10.40/DIMM 2-3	128,00	78	A5-662.33.40/DIMM 2-3	200,00	69	A5-678.07.30	130,00	80
A5-606.07.30	88,00	79	A5-663.22.30	170,00	70	A5-678.07.30/DIMM 2-3	170,00	80

CODICE	€ (IVA esclusa) / (VAT excluded)	P.	CODICE	€ (IVA esclusa) / (VAT excluded)	P.	CODICE	€ (IVA esclusa) / (VAT excluded)	P.	CODICE	€ (IVA esclusa) / (VAT excluded)	P.	CODICE	€ (IVA esclusa) / (VAT excluded)	P.	CODICE	€ (IVA esclusa) / (VAT excluded)	P.
A5-678.07.40	130,00	80	<b>A6</b>			A6-604P.084.40/EM	360,00	112	A6-604PL.112.30	220,00	112	A6-604S.112.40	200,00	113	A6-606.2.112.40/DIMM 2-3	369,00	100
A5-678.07.40/DIMM 2-3	170,00	80	A6-011	19,00	122-123	A6-604P.112.30	269,00	112	A6-604PL.112.30/DIMM 2-3	250,00	112	A6-604S.112.40/DIMM 2-3	228,00	113	A6-606.2.112.40/EM	455,00	100
A5-678.10.30	130,00	80	A6-012	4,30	122-123	A6-604P.112.30/DIMM 2-3	320,00	112	A6-604PL.112.30/EM	360,00	112	A6-604S.112.40/EM	340,00	113	A6-606.2.140.30	384,00	100
A5-678.10.30/DIMM 2-3	170,00	80			112-113	A6-604P.112.30/EM	409,00	112	A6-604PL.112.40	220,00	112	A6-604S.140.30	243,00	113	A6-606.2.140.30/DIMM 2-3	443,00	100
A5-678.10.40	130,00	80	A6-015/100	10,00	114-115 116-117	A6-604P.112.40	263,00	112	A6-604PL.112.40/DIMM 2-3	250,00	112	A6-604S.140.30/DIMM 2-3	268,00	113	A6-606.2.140.30/EM	524,00	100
A5-678.10.40/DIMM 2-3	170,00	80			120-121	A6-604P.112.40/DIMM 2-3	320,00	112	A6-604PL.112.40/EM	360,00	112	A6-604S.140.30/EM	383,00	113	A6-606.2.140.40	384,00	100
A5-679.12.30	154,00	81			122	A6-604P.112.40/EM	409,00	112	A6-604PL.140.30	265,00	112	A6-604S.140.40	243,00	113	A6-606.2.140.40/DIMM 2-3	443,00	100
A5-679.12.30/DIMM 2-3	194,00	81	A6-017	15,50	122	A6-604P.140.30	325,00	112	A6-604PL.140.30/DIMM 2-3	293,00	112	A6-604S.140.40/DIMM 2-3	268,00	113	A6-606.2.140.40/EM	524,00	100
A5-679.12.40	154,00	81	A6-019.3	38,00	98-110 122	A6-604P.140.30/DIMM 2-3	376,00	112	A6-604PL.140.30/EM	405,00	112	A6-604S.140.40/EM	383,00	113	A6-606.2.168.30	442,00	100
A5-679.12.40/DIMM 2-3	194,00	81			122	A6-604P.140.30/EM	465,00	112	A6-604PL.140.40	265,00	112	A6-604S.168.30	272,00	113	A6-606.2.168.30/DIMM 2-3	509,00	100
A5-679.18.30	159,00	81	A6-019.4	42,00	98-110 122	A6-604P.140.40	325,00	112	A6-604PL.140.40/DIMM 2-3	293,00	112	A6-604S.168.30/DIMM 2-3	306,00	113	A6-606.2.168.30/EM	582,00	100
A5-679.18.30/DIMM 2-3	199,00	81			122	A6-604P.140.40/DIMM 2-3	376,00	112	A6-604PL.140.40/EM	405,00	112	A6-604S.168.30/EM	412,00	113	A6-606.2.168.40	442,00	100
A5-679.18.40	159,00	81	A6-019.5	52,00	98-110 122	A6-604P.140.40/EM	465,00	112	A6-604PL.168.30	298,00	112	A6-604S.168.40	272,00	113	A6-606.2.168.40/DIMM 2-3	509,00	100
A5-679.18.40/DIMM 2-3	199,00	81	A6-021	19,00	123	A6-604P.168.30	397,00	112	A6-604PL.168.30/DIMM 2-3	335,00	112	A6-604S.168.40/DIMM 2-3	306,00	113	A6-606.2.168.40/EM	582,00	100
A5-680.07.30	85,00	73	A6-028	18,00	128	A6-604P.168.30/DIMM 2-3	420,00	112	A6-604PL.168.30/EM	438,00	112	A6-604S.168.40/EM	412,00	113	A6-606.2.196.30	495,00	100
A5-680.07.30/DIMM 2-3	115,00	73	A6-029	5,00	128	A6-604P.168.30/EM	537,00	112	A6-604PL.168.40	298,00	112	A6-604S.196.30	320,00	113	A6-606.2.196.30/DIMM 2-3	556,00	100
A5-680.12.30	87,00	73	A6-030	10,00	128	A6-604P.168.40	397,00	112	A6-604PL.168.40/DIMM 2-3	335,00	112	A6-604S.196.30/DIMM 2-3	345,00	113	A6-606.2.196.30/EM	635,00	100
A5-680.12.30/DIMM 2-3	117,00	73	A6-031	9,00	124	A6-604P.168.40/DIMM 2-3	420,00	112	A6-604PL.168.40/EM	438,00	112	A6-604S.196.30/EM	460,00	113	A6-606.2.196.40	495,00	100
A5-680.15.30	89,00	73	A6-032	4,00	124	A6-604P.168.40/EM	537,00	112	A6-604PL.196.30	350,00	112	A6-604S.196.40	320,00	113	A6-606.2.196.40/DIMM 2-3	556,00	100
A5-680.15.30/DIMM 2-3	119,00	73	A6-033	10,00	124	A6-604P.196.30	460,00	112	A6-604PL.196.30/DIMM 2-3	378,00	112	A6-604S.196.40/DIMM 2-3	345,00	113	A6-606.2.196.40/EM	635,00	100
A5-681.07.30	69,00	83	A6-036	15,50	98-110	A6-604P.196.30/DIMM 2-3	550,00	112	A6-604PL.196.30/EM	490,00	112	A6-604S.196.40/EM	460,00	113	A6-606.2.224.30	543,00	100
A5-681.07.30/DIMM 2-3	109,00	83	A6-037	4,30	110-111	A6-604P.196.30/EM	600,00	112	A6-604PL.196.40	350,00	112	A6-604S.224.30	353,00	113	A6-606.2.224.30/DIMM 2-3	597,00	100
A5-681.10.30	79,00	83	A6-038	30,00	111	A6-604P.196.40	460,00	112	A6-604PL.196.40/DIMM 2-3	378,00	112	A6-604S.224.30/DIMM 2-3	380,00	113	A6-606.2.224.30/EM	683,00	100
A5-681.10.30/DIMM 2-3	119,00	83	A6-039	30,00	111	A6-604P.196.40/DIMM 2-3	550,00	112	A6-604PL.196.40/EM	490,00	112	A6-604S.224.30/EM	493,00	113	A6-606.2.224.40	543,00	100
A5-682.07.30	69,00	83	A6-040	10,00	111	A6-604P.196.40/EM	600,00	112	A6-604PL.224.30	386,00	112	A6-604S.224.40	353,00	113	A6-606.2.224.40/DIMM 2-3	597,00	100
A5-682.07.30/DIMM 2-3	109,00	83	A6-045.02-08	72,00	98	A6-604P.224.30	507,00	112	A6-604PL.224.30/DIMM 2-3	415,00	112	A6-604S.224.40/DIMM 2-3	380,00	113	A6-606.2.224.40/EM	683,00	100
A5-682.10.30	79,00	83	A6-045.46	92,00	98	A6-604P.224.30/DIMM 2-3	590,00	112	A6-604PL.224.30/EM	526,00	112	A6-604S.224.40/EM	493,00	113	A6-606.2.252.30	612,00	100
A5-682.10.30/DIMM 2-3	119,00	83	A6-047	7,50	98	A6-604P.224.30/EM	647,00	112	A6-604PL.224.40	386,00	112	A6-604S.252.30	393,00	113	A6-606.2.252.30/DIMM 2-3	673,00	100
A5-685.07.30	85,00	85	<b>A6-048PL.2.30.02-08</b>	357,00	98	A6-604P.224.40	507,00	112	A6-604PL.224.40/DIMM 2-3	415,00	112	A6-604S.252.30/DIMM 2-3	420,00	113	A6-606.2.252.30/EM	752,00	100
A5-685.10.30	85,00	85	A6-048PL.2.30.46	392,00	98	A6-604P.224.40/DIMM 2-3	590,00	112	A6-604PL.224.40/EM	526,00	112	A6-604S.252.30/EM	533,00	113	A6-606.2.252.40	612,00	100
A5-686.07.30	85,00	85	A6-048PL.2.40.02-08	357,00	98	A6-604P.224.40/EM	647,00	112	A6-604PL.252.30	430,00	112	A6-604S.252.40	393,00	113	A6-606.2.252.40/DIMM 2-3	673,00	100
A5-686.10.30	85,00	85	A6-048PL.2.40.46	392,00	98	A6-604P.252.30	563,00	112	A6-604PL.252.30/DIMM 2-3	460,00	112	A6-604S.252.40/DIMM 2-3	420,00	113	A6-606.2.252.40/EM	752,00	100
A5-687.07.30	85,00	84	<b>A6-048PL.30.02-08</b>	258,00	98	A6-604P.252.30/DIMM 2-3	660,00	112	A6-604PL.252.30/EM	570,00	112	A6-604S.252.40/EM	533,00	113	A6-606.2.280.30	710,00	100
A5-687.10.30	85,00	84	A6-048PL.30.46	288,00	98	A6-604P.252.30/EM	703,00	112	A6-604PL.252.40	430,00	112	A6-604S.280.30	443,00	113	A6-606.2.280.30/DIMM 2-3	790,00	100
A5-688.07.30	85,00	84	A6-048PL.40.02-08	258,00	98	A6-604P.252.40	563,00	112	A6-604PL.252.40/DIMM 2-3	460,00	112	A6-604S.280.30/DIMM 2-3	516,00	113	A6-606.2.280.30/EM	850,00	100
A5-688.10.30	85,00	84	A6-048PL.40.46	288,00	98	A6-604P.252.40/DIMM 2-3	660,00	112	A6-604PL.252.40/EM	570,00	112	A6-604S.280.30/EM	583,00	113	A6-606.2.280.40	710,00	100
A5-692.30	390,00	64	<b>A6-048S.2.30.02-08</b>	335,00	98	A6-604P.252.40/EM	703,00	112	A6-604PL.280.30	485,00	112	A6-604S.280.40	443,00	113	A6-606.2.280.40/DIMM 2-3	790,00	100
A5-692.30/DIMM 2-3	430,00	64	A6-048S.2.30.46	368,00	98	A6-604P.280.30	638,00	112	A6-604PL.280.30/DIMM 2-3	565,00	112	A6-604S.280.40/DIMM 2-3	516,00	113	A6-606.2.280.40/EM	850,00	100
A5-692.30/EM	530,00	64	A6-048S.2.40.02-08	335,00	98	A6-604P.280.30/DIMM 2-3	710,00	112	A6-604PL.280.30/EM	625,00	112	A6-604S.280.40/EM	583,00	113	<b>A6-607.2.084.30</b>	355,00	100
A5-692.40	390,00	64	A6-048S.2.40.46	368,00	98	A6-604P.280.30/EM	778,00	112	A6-604PL.280.40	485,00	112	<b>A6-606.2.084.30</b>	263,00	100	A6-607.2.084.30/DIMM 2-3	430,00	100
A5-692.40/DIMM 2-3	430,00	64	<b>A6-048S.30.02-08</b>	242,00	98	A6-604P.280.40	638,00	112	A6-604PL.280.40/DIMM 2-3	565,00	112	A6-606.2.084.30/DIMM 2-3	323,00	100	A6-607.2.084.30/EM	475,00	100
A5-692.40/EM	530,00	64	A6-048S.30.46	271,00	98	A6-604P.280.40/DIMM 2-3	710,00	112	A6-604PL.280.40/EM	625,00	112	A6-606.2.084.30/EM	403,00	100	A6-607.2.084.40	355,00	100
A5-693.70.30	690,00	64	A6-048S.40.02-08	242,00	98	A6-604P.280.40/EM	778,00	112	<b>A6-604S.084.30</b>	164,00	113	A6-606.2.084.40	263,00	100	A6-607.2.084.40/DIMM 2-3	430,00	100
A5-693.70.30/DIMM 2-3	730,00	64	A6-048S.40.46	271,00	98	<b>A6-604PL.084.30</b>	180,00	112	A6-604S.084.30/EM	304,00	113	A6-606.2.084.40/DIMM 2-3	323,00	100	A6-607.2.084.40/EM	475,00	100
A5-693.70.30/EM	830,00	64	<b>A6-604P.084.30</b>	220,00	112	A6-604PL.084.30/DIMM 2-3	220,00	112	A6-604S.084.40	164,00	113	A6-606.2.084.40/EM	403,00	100	A6-607.2.112.30	426,00	100
A5-693.70.40	690,00	64	A6-604P.084.30/DIMM 2-3	260,00	112	A6-604PL.084.30/EM	320,00	112	A6-604S.084.40/EM	304,00	113	A6-606.2.112.30	315,00	100	A6-607.2.112.30/DIMM 2-3	498,00	100
A5-693.70.40/DIMM 2-3	730,00	64	A6-604P.084.30/EM	360,00	112	A6-604PL.084.40	180,00	112	A6-604S.112.30	200,00	113	A6-606.2.112.30/DIMM 2-3	369,00	100	A6-607.2.112.30/EM	566,00	100
A5-693.70.40/EM	830,00	64	A6-604P.084.40	220,00	112	A6-604PL.084.40/DIMM 2-3	220,00	112	A6-								

CODICE	€ (IVA esclusa) / (VAT excluded)	P.	CODICE	€ (IVA esclusa) / (VAT excluded)	P.	CODICE	€ (IVA esclusa) / (VAT excluded)	P.
A6-607.2.112.40/EM	566,00	100	A6-614P.140.30	337,00	114	A6-614PL.140.30/DIMM 2-3	308,00	114
A6-607.2.140.30	498,00	100	A6-614P.140.30/DIMM 2-3	388,00	114	A6-614PL.140.30/EM	416,00	114
A6-607.2.140.30/DIMM 2-3	597,00	100	A6-614P.140.30/EM	477,00	114	A6-614PL.140.40	276,00	114
A6-607.2.140.30/EM	638,00	100	A6-614P.140.40	337,00	114	A6-614PL.140.40/DIMM 2-3	308,00	114
A6-607.2.140.40	498,00	100	A6-614P.140.40/DIMM 2-3	388,00	114	A6-614PL.140.40/EM	416,00	114
A6-607.2.140.40/DIMM 2-3	597,00	100	A6-614P.140.40/EM	477,00	114	A6-614PL.168.30	313,00	114
A6-607.2.140.40/EM	638,00	100	A6-614P.168.30	409,00	114	A6-614PL.168.30/DIMM 2-3	348,00	114
A6-607.2.168.30	610,00	100	A6-614P.168.30/DIMM 2-3	432,00	114	A6-614PL.168.30/EM	453,00	114
A6-607.2.168.30/DIMM 2-3	680,00	100	A6-614P.168.40	549,00	114	A6-614PL.168.40	313,00	114
A6-607.2.168.30/EM	750,00	100	A6-614P.168.40/DIMM 2-3	432,00	114	A6-614PL.168.40/DIMM 2-3	348,00	114
A6-607.2.168.40	610,00	100	A6-614P.168.40/EM	549,00	114	A6-614PL.168.40/EM	453,00	114
A6-607.2.168.40/DIMM 2-3	680,00	100	A6-614P.196.30	478,00	114	A6-614PL.196.30	365,00	114
A6-607.2.168.40/EM	750,00	100	A6-614P.196.30/DIMM 2-3	560,00	114	A6-614PL.196.30/DIMM 2-3	398,00	114
A6-607.2.196.30	720,00	100	A6-614P.196.30/EM	618,00	114	A6-614PL.196.30/EM	505,00	114
A6-607.2.196.30/DIMM 2-3	870,00	100	A6-614P.196.40	478,00	114	A6-614PL.196.40	365,00	114
A6-607.2.196.30/EM	860,00	100	A6-614P.196.40/DIMM 2-3	560,00	114	A6-614PL.196.40/DIMM 2-3	398,00	114
A6-607.2.196.40	720,00	100	A6-614P.196.40/EM	618,00	114	A6-614PL.196.40/EM	505,00	114
A6-607.2.196.40/DIMM 2-3	870,00	100	A6-614P.224.30	524,00	114	A6-614PL.224.30	410,00	114
A6-607.2.196.40/EM	860,00	100	A6-614P.224.30/DIMM 2-3	605,00	114	A6-614PL.224.30/DIMM 2-3	436,00	114
A6-607.2.224.30	797,00	100	A6-614P.224.30/EM	664,00	114	A6-614PL.224.30/EM	550,00	114
A6-607.2.224.30/DIMM 2-3	980,00	100	A6-614P.224.40	524,00	114	A6-614PL.224.40	410,00	114
A6-607.2.224.30/EM	937,00	100	A6-614P.224.40/DIMM 2-3	605,00	114	A6-614PL.224.40/DIMM 2-3	436,00	114
A6-607.2.224.40	797,00	100	A6-614P.224.40/EM	664,00	114	A6-614PL.224.40/EM	550,00	114
A6-607.2.224.40/DIMM 2-3	980,00	100	A6-614P.252.30	580,00	114	A6-614PL.252.30	450,00	114
A6-607.2.224.40/EM	937,00	100	A6-614P.252.30/DIMM 2-3	670,00	114	A6-614PL.252.30/DIMM 2-3	484,00	114
A6-607.2.252.30	898,00	100	A6-614P.252.30/EM	720,00	114	A6-614PL.252.30/EM	600,00	114
A6-607.2.252.30/DIMM 2-3	1040,00	100	A6-614P.252.40	580,00	114	A6-614PL.252.40	450,00	114
A6-607.2.252.30/EM	1038,00	100	A6-614P.252.40/DIMM 2-3	670,00	114	A6-614PL.252.40/DIMM 2-3	484,00	114
A6-607.2.252.40	898,00	100	A6-614P.252.40/EM	720,00	114	A6-614PL.252.40/EM	600,00	114
A6-607.2.252.40/DIMM 2-3	1040,00	100	A6-614P.280.30	658,00	114	A6-614PL.280.30	513,00	114
A6-607.2.252.40/EM	1038,00	100	A6-614P.280.30/DIMM 2-3	727,00	114	A6-614PL.280.30/DIMM 2-3	578,00	114
A6-607.2.280.30	990,00	100	A6-614P.280.30/EM	798,00	114	A6-614PL.280.30/EM	653,00	114
A6-607.2.280.30/DIMM 2-3	1130,00	100	A6-614P.280.40	658,00	114	A6-614PL.280.40	513,00	114
A6-607.2.280.30/EM	1130,00	100	A6-614P.280.40/DIMM 2-3	727,00	114	A6-614PL.280.40/DIMM 2-3	578,00	114
A6-607.2.280.40	990,00	100	A6-614P.280.40/EM	798,00	114	A6-614PL.280.40/EM	653,00	114
A6-607.2.280.40/DIMM 2-3	1130,00	100	<b>A6-614PL.084.30</b>	191,00	114	<b>A6-614S.084.30</b>	174,00	115
A6-607.2.280.40/EM	1130,00	100	A6-614PL.084.30/DIMM 2-3	228,00	114	A6-614S.084.30/EM	314,00	115
<b>A6-614P.084.30</b>	230,00	114	A6-614PL.084.30/EM	331,00	114	A6-614S.084.40	174,00	115
A6-614P.084.30/DIMM 2-3	278,00	114	A6-614PL.084.40	191,00	114	A6-614S.084.40/EM	314,00	115
A6-614P.084.30/EM	370,00	114	A6-614PL.084.40/DIMM 2-3	228,00	114	A6-614S.112.30	209,00	115
A6-614P.084.40	230,00	114	A6-614PL.084.40/EM	331,00	114	A6-614S.112.30/DIMM 2-3	237,00	115
A6-614P.084.40/DIMM 2-3	278,00	114	A6-614PL.112.30	228,00	114	A6-614S.112.30/EM	349,00	115
A6-614P.084.40/EM	370,00	114	A6-614PL.112.30/DIMM 2-3	260,00	114	A6-614S.112.40	209,00	115
A6-614P.112.30	274,00	114	A6-614PL.112.30/EM	368,00	114	A6-614S.112.40/DIMM 2-3	237,00	115
A6-614P.112.30/DIMM 2-3	330,00	114	A6-614PL.112.40	228,00	114	A6-614S.112.40/EM	349,00	115
A6-614P.112.30/EM	414,00	114	A6-614PL.112.40/DIMM 2-3	260,00	114	A6-614S.140.30	252,00	115
A6-614P.112.40	274,00	114	A6-614PL.112.40/EM	368,00	114	A6-614S.140.30/DIMM 2-3	281,00	115
A6-614P.112.40/DIMM 2-3	330,00	114	<b>A6-614PL.140.30</b>	276,00	114	A6-614S.140.40	392,00	115
A6-614P.112.40/EM	414,00	114				A6-614S.140.40/EM	252,00	115

CODICE	€ (IVA esclusa) / (VAT excluded)	P.	CODICE	€ (IVA esclusa) / (VAT excluded)	P.	CODICE	€ (IVA esclusa) / (VAT excluded)	P.
<b>A6-614S.140.40/DIMM 2-3</b>	281,00	115	<b>A6-616.140.40/EM</b>	435,00	103	<b>A6-617.168.30</b>	424,00	103
<b>A6-614S.140.40/EM</b>	392,00	115	<b>A6-616.168.30</b>	330,00	103	<b>A6-617.168.30/DIMM 2-3</b>	445,00	103
<b>A6-614S.168.30</b>	286,00	115	<b>A6-616.168.30/DIMM 2-3</b>	361,00	103	<b>A6-617.168.30/EM</b>	564,00	103
<b>A6-614S.168.30/DIMM 2-3</b>	318,00	115	<b>A6-616.168.30/EM</b>	470,00	103	<b>A6-617.168.40</b>	424,00	103
<b>A6-614S.168.30/EM</b>	426,00	115	<b>A6-616.168.40</b>	330,00	103	<b>A6-617.168.40/DIMM 2-3</b>	445,00	103
<b>A6-614S.168.40</b>	286,00	115	<b>A6-616.168.40/DIMM 2-3</b>	361,00	103	<b>A6-617.168.40/EM</b>	564,00	103
<b>A6-614S.168.40/DIMM 2-3</b>	318,00	115	<b>A6-616.168.40/EM</b>	470,00	103	<b>A6-617.196.30</b>	488,00	103
<b>A6-614S.168.40/EM</b>	426,00	115	<b>A6-616.196.30</b>	372,00	103	<b>A6-617.196.30/DIMM 2-3</b>	563,00	103
<b>A6-614S.196.30</b>	334,00	115	<b>A6-616.196.30/DIMM 2-3</b>	409,00	103	<b>A6-617.196.30/EM</b>	628,00	103
<b>A6-614S.196.30/DIMM 2-3</b>	364,00	115	<b>A6-616.196.30/EM</b>	512,00	103	<b>A6-617.196.40</b>	488,00	103
<b>A6-614S.196.30/EM</b>	474,00	115	<b>A6-616.196.40</b>	372,00	103	<b>A6-617.196.40/DIMM 2-3</b>	563,00	103
<b>A6-614S.196.40</b>	334,00	115	<b>A6-616.196.40/DIMM 2-3</b>	409,00	103	<b>A6-617.196.40/EM</b>	628,00	103
<b>A6-614S.196.40/DIMM 2-3</b>	364,00	115	<b>A6-616.196.40/EM</b>	512,00	103	<b>A6-617.224.30</b>	533,00	103
<b>A6-614S.196.40/EM</b>	474,00	115	<b>A6-616.224.30</b>	410,00	103	<b>A6-617.224.30/DIMM 2-3</b>	607,00	103
<b>A6-614S.224.30</b>	373,00	115	<b>A6-616.224.30/DIMM 2-3</b>	425,00	103	<b>A6-617.224.30/EM</b>	673,00	103
<b>A6-614S.224.30/DIMM 2-3</b>	398,00	115	<b>A6-616.224.30/EM</b>	550,00	103	<b>A6-617.224.40</b>	533,00	103
<b>A6-614S.224.30/EM</b>	513,00	115	<b>A6-616.224.40</b>	410,00	103	<b>A6-617.224.40/DIMM 2-3</b>	607,00	103
<b>A6-614S.224.40</b>	373,00	115	<b>A6-616.224.40/DIMM 2-3</b>	425,00	103	<b>A6-617.224.40/EM</b>	673,00	103
<b>A6-614S.224.40/DIMM 2-3</b>	398,00	115	<b>A6-616.224.40/EM</b>	550,00	103	<b>A6-617.252.30</b>	588,00	103
<b>A6-614S.224.40/EM</b>	513,00	115	<b>A6-616.252.30</b>	450,00	103	<b>A6-617.252.30/DIMM 2-3</b>	670,00	103
<b>A6-614S.252.30</b>	410,00	115	<b>A6-616.252.30/DIMM 2-3</b>	470,00	103	<b>A6-617.252.30/EM</b>	728,00	103
<b>A6-614S.252.30/DIMM 2-3</b>	442,00	115	<b>A6-616.252.30/EM</b>	590,00	103	<b>A6-617.252.40</b>	588,00	103
<b>A6-614S.252.30/EM</b>	550,00	115	<b>A6-616.252.40</b>	450,00	103	<b>A6-617.252.40/DIMM 2-3</b>	670,00	103
<b>A6-614S.252.40</b>	410,00	115	<b>A6-616.252.40/DIMM 2-3</b>	470,00	103	<b>A6-617.252.40/EM</b>	728,00	103
<b>A6-614S.252.40/DIMM 2-3</b>	442,00	115	<b>A6-616.280.30</b>	499,00	103	<b>A6-617.280.30</b>	646,00	103
<b>A6-614S.252.40/EM</b>	550,00	115	<b>A6-616.280.30/DIMM 2-3</b>	560,00	103	<b>A6-617.280.30/DIMM 2-3</b>	725,00	103
<b>A6-614S.280.30</b>	469,00	115	<b>A6-616.280.30/EM</b>	639,00	103	<b>A6-617.280.40</b>	786,00	103
<b>A6-614S.280.30/DIMM 2-3</b>	528,00	115	<b>A6-616.280.40</b>	499,00	103	<b>A6-617.280.40/DIMM 2-3</b>	786,00	103
<b>A6-614S.280.30/EM</b>	609,00	115	<b>A6-616.280.40/DIMM 2-3</b>	560,00	103	<b>A6-617.280.40/EM</b>	786,00	103
<b>A6-614S.280.40</b>	469,00	115	<b>A6-616.280.40/EM</b>	639,00	103	<b>A6-624P.084.30</b>	251,00	116
<b>A6-614S.280.40/DIMM 2-3</b>	528,00	115	<b>A6-617.084.30</b>	253,00	103	<b>A6-624P.084.30/DIMM 2-3</b>	286,00	116
<b>A6-614S.280.40/EM</b>	609,00	115	<b>A6-617.084.30/DIMM 2-3</b>	290,00	103	<b>A6-624P.084.30/EM</b>	391,00	116
<b>A6-616.084.30</b>	211,00	103	<b>A6-617.084.30/EM</b>	393,00	103	<b>A6-624P.084.40</b>	251,00	116
<b>A6-616.084.30/DIMM 2-3</b>	244,00	103	<b>A6-617.084.40</b>	253,00	103	<b>A6-624P.084.40/DIMM 2-3</b>	286,00	116
<b>A6-616.084.30/EM</b>	351,00	103	<b>A6-617.084.40/DIMM 2-3</b>	290,00	103	<b>A6-624P.084.40/EM</b>	391,00	116
<b>A6-616.084.40</b>	211,00	103	<b>A6-617.084.40/EM</b>	393,00	103	<b>A6-624P.112.30</b>	290,00	116
<b>A6-616.084.40/DIMM 2-3</b>	244,00	103	<b>A6-617.112.30</b>	292,00	103	<b>A6-624P.112.30/DIMM 2-3</b>	339,00	116
<b>A6-616.084.40/EM</b>	351,00	103	<b>A6-617.112.30/DIMM 2-3</b>	337,00	103	<b>A6-624P.112.30/EM</b>	430,00	116
<b>A6-616.112.30</b>	244,00	103	<b>A6-617.112.30/EM</b>	432,00	103	<b>A6-624P.112.40</b>	290,00	116
<b>A6-616.112.30/DIMM 2-3</b>	276,00	103	<b>A6-617.112.40</b>	292,00	103	<b>A6-624P.112.40/DIMM 2-3</b>	339,00	116
<b>A6-616.112.30/EM</b>	384,00	103	<b>A6-617.112.40/DIMM 2-3</b>	337,00	103	<b>A6-624P.112.40/EM</b>	430,00	116
<b>A6-616.112.40</b>	244,00	103	<b>A6-617.112.40/EM</b>	432,00	103	<b>A6-624P.140.30</b>	350,00	116
<b>A6-616.112.40/DIMM 2-3</b>	276,00	103	<b>A6-617.140.30</b>	357,00	103	<b>A6-624P.140.30/DIMM 2-3</b>	399,00	116
<b>A6-616.112.40/EM</b>	384,00	103	<b>A6-61</b>					

CODICE	€ (IVA esclusa) / (VAT excluded)	P.	CODICE	€ (IVA esclusa) / (VAT excluded)	P.	CODICE	€ (IVA esclusa) / (VAT excluded)	P.
A6-624P.168.30/DIMM 2-3	445,00	116	A6-624PL.168.30/EM	465,00	116	A6-624S.168.40/EM	437,00	117
A6-624P.168.30/EM	562,00	116	A6-624PL.168.40	325,00	116	A6-624S.196.30	347,00	117
A6-624P.168.40	422,00	116	A6-624PL.168.40/DIMM 2-3	360,00	116	A6-624S.196.30/DIMM 2-3	372,00	117
A6-624P.168.40/DIMM 2-3	445,00	116	A6-624PL.168.40/EM	465,00	116	A6-624S.196.30/EM	487,00	117
A6-624P.168.40/EM	562,00	116	A6-624PL.196.30	380,00	116	A6-624S.196.40	347,00	117
A6-624P.196.30	490,00	116	A6-624PL.196.30/DIMM 2-3	405,00	116	A6-624S.196.40/DIMM 2-3	372,00	117
A6-624P.196.30/DIMM 2-3	572,00	116	A6-624PL.196.30/EM	520,00	116	A6-624S.196.40/EM	487,00	117
A6-624P.196.30/EM	630,00	116	A6-624PL.196.40	380,00	116	A6-624S.224.30	380,00	117
A6-624P.196.40	490,00	116	A6-624PL.196.40/DIMM 2-3	405,00	116	A6-624S.224.30/DIMM 2-3	408,00	117
A6-624P.196.40/DIMM 2-3	572,00	116	A6-624PL.196.40/EM	520,00	116	A6-624S.224.30/EM	520,00	117
A6-624P.196.40/EM	630,00	116	A6-624PL.224.30	416,00	116	A6-624S.224.40	380,00	117
A6-624P.224.30	532,00	116	A6-624PL.224.30/DIMM 2-3	446,00	116	A6-624S.224.40/DIMM 2-3	408,00	117
A6-624P.224.30/DIMM 2-3	610,00	116	A6-624PL.224.30/EM	556,00	116	A6-624S.224.40/EM	520,00	117
A6-624P.224.30/EM	672,00	116	A6-624PL.224.40	416,00	116	A6-624S.252.30	420,00	117
A6-624P.224.40	532,00	116	A6-624PL.224.40/DIMM 2-3	446,00	116	A6-624S.252.30/DIMM 2-3	457,00	117
A6-624P.224.40/DIMM 2-3	610,00	116	A6-624PL.224.40/EM	556,00	116	A6-624S.252.30/EM	560,00	117
A6-624P.224.40/EM	672,00	116	A6-624PL.252.30	460,00	116	A6-624S.252.40	420,00	117
A6-624P.252.30	595,00	116	A6-624PL.252.30/DIMM 2-3	495,00	116	A6-624S.252.40/DIMM 2-3	457,00	117
A6-624P.252.30/DIMM 2-3	685,00	116	A6-624PL.252.30/EM	600,00	116	A6-624S.252.40/EM	560,00	117
A6-624P.252.30/EM	735,00	116	A6-624PL.252.40	460,00	116	A6-624S.280.30	470,00	117
A6-624P.252.40	595,00	116	A6-624PL.252.40/DIMM 2-3	495,00	116	A6-624S.280.30/DIMM 2-3	539,00	117
A6-624P.252.40/DIMM 2-3	685,00	116	A6-624PL.252.40/EM	600,00	116	A6-624S.280.30/EM	610,00	117
A6-624P.252.40/EM	735,00	116	A6-624PL.280.30	515,00	116	A6-624S.280.40	470,00	117
A6-624P.280.30	670,00	116	A6-624PL.280.30/DIMM 2-3	590,00	116	A6-624S.280.40/DIMM 2-3	539,00	117
A6-624P.280.30/DIMM 2-3	740,00	116	A6-624PL.280.30/EM	655,00	116	A6-624S.280.40/EM	610,00	117
A6-624P.280.30/EM	810,00	116	A6-624PL.280.40	515,00	116	<b>A6-626P.084.30</b>	248,00	120
A6-624P.280.40	670,00	116	A6-624PL.280.40/DIMM 2-3	590,00	116	A6-626P.084.30/DIMM 2-3	286,00	120
A6-624P.280.40/DIMM 2-3	740,00	116	A6-624PL.280.40/EM	655,00	116	A6-626P.084.30/EM	388,00	120
A6-624P.280.40/EM	810,00	116	<b>A6-624S.084.30</b>	184,00	117	A6-626P.084.40	248,00	120
<b>A6-624PL.084.30</b>	201,00	116	A6-624S.084.30/EM	324,00	117	A6-626P.084.40/DIMM 2-3	286,00	120
A6-624PL.084.30/DIMM 2-3	240,00	116	A6-624S.084.40	184,00	117	A6-626P.084.40/EM	388,00	120
A6-624PL.084.30/EM	341,00	116	A6-624S.084.40/EM	324,00	117	A6-626P.112.30	297,00	120
A6-624PL.084.40	201,00	116	A6-624S.112.30	214,00	117	A6-626P.112.30/DIMM 2-3	350,00	120
A6-624PL.084.40/DIMM 2-3	240,00	116	A6-624S.112.30/DIMM 2-3	255,00	117	A6-626P.112.30/EM	437,00	120
A6-624PL.084.40/EM	341,00	116	A6-624S.112.30/EM	354,00	117	A6-626P.112.40	297,00	120
A6-624PL.112.30	235,00	116	A6-624S.112.40	214,00	117	A6-626P.112.40/DIMM 2-3	350,00	120
A6-624PL.112.30/DIMM 2-3	278,00	116	A6-624S.112.40/DIMM 2-3	255,00	117	A6-626P.112.40/EM	437,00	120
A6-624PL.112.30/EM	375,00	116	A6-624S.112.40/EM	354,00	117	A6-626P.140.30	353,00	120
A6-624PL.112.40	235,00	116	A6-624S.140.30	255,00	117	A6-626P.140.30/DIMM 2-3	398,00	120
A6-624PL.112.40/DIMM 2-3	278,00	116	A6-624S.140.30/DIMM 2-3	300,00	117	A6-626P.140.30/EM	493,00	120
A6-624PL.112.40/EM	375,00	116	A6-624S.140.30/EM	395,00	117	A6-626P.140.40	353,00	120
A6-624PL.140.30	280,00	116	A6-624S.140.40	255,00	117	A6-626P.140.40/DIMM 2-3	398,00	120
A6-624PL.140.30/DIMM 2-3	328,00	116	A6-624S.140.40/DIMM 2-3	300,00	117	A6-626P.140.40/EM	493,00	120
A6-624PL.140.30/EM	420,00	116	A6-624S.140.40/EM	395,00	117	A6-626P.168.30	422,00	120
A6-624PL.140.40	280,00	116	A6-624S.168.30	297,00	117	A6-626P.168.30/DIMM 2-3	450,00	120
A6-624PL.140.40/DIMM 2-3	328,00	116	A6-624S.168.30/DIMM 2-3	329,00	117	A6-626P.168.30/EM	562,00	120
A6-624PL.140.40/EM	420,00	116	A6-624S.168.30/EM	437,00	117	A6-626P.168.40	422,00	120
A6-624PL.168.30	325,00	116	A6-624S.168.40	297,00	117	A6-626P.168.40/DIMM 2-3	450,00	120
A6-624PL.168.30/DIMM 2-3	360,00	116	A6-624S.168.40/DIMM 2-3	329,00	117	A6-626P.168.40/EM	562,00	120

CODICE	€ (IVA esclusa) / (VAT excluded)	P.	CODICE	€ (IVA esclusa) / (VAT excluded)	P.	CODICE	€ (IVA esclusa) / (VAT excluded)	P.
<b>A6-626P.196.30</b>	500,00	120	A6-626PL.196.30/DIMM 2-3	420,00	120	A6-626S.196.40/DIMM 2-3	384,00	121
A6-626P.196.30/DIMM 2-3	594,00	120	A6-626PL.196.30/EM	525,00	120	A6-626S.196.40/EM	491,00	121
A6-626P.196.30/EM	640,00	120	A6-626PL.196.40	385,00	120	A6-626S.224.30	393,00	121
A6-626P.196.40	500,00	120	A6-626PL.196.40/DIMM 2-3	420,00	120	A6-626S.224.30/DIMM 2-3	426,00	121
A6-626P.196.40/DIMM 2-3	594,00	120	A6-626PL.196.40/EM	525,00	120	A6-626S.224.30/EM	533,00	121
A6-626P.196.40/EM	640,00	120	A6-626PL.224.30	430,00	120	A6-626S.224.40	393,00	121
A6-626P.224.30	549,00	120	A6-626PL.224.30/DIMM 2-3	466,00	120	A6-626S.224.40/DIMM 2-3	426,00	121
A6-626P.224.30/DIMM 2-3	645,00	120	A6-626PL.224.30/EM	570,00	120	A6-626S.224.40/EM	533,00	121
A6-626P.224.30/EM	689,00	120	A6-626PL.224.40	430,00	120	A6-626S.252.30	434,00	121
A6-626P.224.40	549,00	120	A6-626PL.224.40/DIMM 2-3	466,00	120	A6-626S.252.30/DIMM 2-3	470,00	121
A6-626P.224.40/DIMM 2-3	645,00	120	A6-626PL.224.40/EM	570,00	120	A6-626S.252.30/EM	574,00	121
A6-626P.224.40/EM	689,00	120	A6-626PL.252.30	475,00	120	A6-626S.252.40	434,00	121
A6-626P.252.30	610,00	120	A6-626PL.252.30/DIMM 2-3	515,00	120	A6-626S.252.40/DIMM 2-3	470,00	121
A6-626P.252.30/DIMM 2-3	715,00	120	A6-626PL.252.30/EM	615,00	120	A6-626S.252.40/EM	574,00	121
A6-626P.252.30/EM	750,00	120	A6-626PL.252.40	475,00	120	A6-626S.280.30	493,00	121
A6-626P.252.40	610,00	120	A6-626PL.252.40/DIMM 2-3	515,00	120	A6-626S.280.30/DIMM 2-3	560,00	121
A6-626P.252.40/DIMM 2-3	715,00	120	A6-626PL.252.40/EM	615,00	120	A6-626S.280.30/EM	633,00	121
A6-626P.252.40/EM	750,00	120	A6-626PL.280.30	540,00	120	A6-626S.280.40	493,00	121
A6-626P.280.30	690,00	120	A6-626PL.280.30/DIMM 2-3	614,00	120	A6-626S.280.40/DIMM 2-3	560,00	121
A6-626P.280.30/DIMM 2-3	770,00	120	A6-626PL.280.30/EM	680,00	120	A6-626S.280.40/EM	633,00	121
A6-626P.280.30/EM	830,00	120	A6-626PL.280.40	540,00	120	<b>A6-636.084.30</b>	180,00	108
A6-626P.280.40	690,00	120	A6-626PL.280.40/DIMM 2-3	614,00	120	A6-636.084.30/DIMM 2-3	219,00	108
A6-626P.280.40/DIMM 2-3	770,00	120	A6-626PL.280.40/EM	680,00	120	A6-636.084.30/EM	320,00	108
A6-626P.280.40/EM	830,00	120	<b>A6-626S.084.30</b>	182,00	121	A6-636.084.40	180,00	108
<b>A6-626PL.084.30</b>	200,00	120	A6-626S.084.30/EM	322,00	121	A6-636.084.40/DIMM 2-3	219,00	108
A6-626PL.084.30/DIMM 2-3	245,00	120	A6-626S.084.40	182,00	121	A6-636.084.40/EM	320,00	108
A6-626PL.084.30/EM	340,00	120	A6-626S.084.40/EM	322,00	121	A6-636.112.30	200,00	108
A6-626PL.084.40	200,00	120	A6-626S.112.30	224,00	121	A6-636.112.30/DIMM 2-3	242,00	108
A6-626PL.084.40/DIMM 2-3	245,00	120	A6-626S.112.30/DIMM 2-3	256,00	121	A6-636.112.30/EM	340,00	108
A6-626PL.084.40/EM	340,00	120	A6-626S.112.30/EM	364,00	121	A6-636.112.40	200,00	108
A6-626PL.112.30	245,00	120	A6-626S.112.40	224,00	121	A6-636.112.40/DIMM 2-3	242,00	108
A6-626PL.112.30/DIMM 2-3	280,00	120	A6-626S.112.40/DIMM 2-3	256,00	121	A6-636.112.40/EM	340,00	108
A6-626PL.112.30/EM	385,00	120	A6-626S.112.40/EM	364,00	121	A6-636.140.30	250,00	108
A6-626PL.112.40	245,00	120	A6-626S.140.30	265,00	121	A6-636.140.30/DIMM 2-3	280,00	108
A6-626PL.112.40/DIMM 2-3	280,00	120	A6-626S.140.30/DIMM 2-3	307,00	121	A6-636.140.30/EM	390,00	108
A6-626PL.112.40/EM	385,00	120	A6-626S.140.30/EM	405,00	121	A6-636.140.40	250,00	108
A6-626PL.140.30	290,00	120	A6-626S.140.40	265,00	121	A6-636.140.40/DIMM 2-3	280,00	108
A6-626PL.140.30/DIMM 2-3	336,00	120	A6-626S.140.40/DIMM 2-3	307,00	121	A6-636.140.40/EM	390,00	108
A6-626PL.140.30/EM	430,00	120	A6-626S.140.40/EM	405,00	121	A6-636.168.30	285,00	108
A6-626PL.140.40	290,00	120	A6-626S.168.30	301,00	121	A6-636.168.30/DIMM 2-3	325,00	108
A6-626PL.140.40/DIMM 2-3	336,00	120	A6-626S.168.30/DIMM 2-3	329,00	121	A6-636.168.30/EM	425,00	108
A6-626PL.140.40/EM	430,00	120	A6-626S.168.30/EM	441,00	121	A6-636.168.40	285,00	108
A6-626PL.168.30	330,00	120	A6-626S.168.40	301,00	121	A6-636.168.40/DIMM 2-3	325,00	108
A6-626PL.168.30/DIMM 2-3	360,00	120	A6-626S.168.40/DIMM 2-3	329,00	121	A6-636.168.40/EM	425,00	108
A6-626PL.168.30/EM	470,00	120	A6-626S.168.40/EM	441,00	121	A6-636.196.30	317,00	108
A6-626PL.168.40	330,00	120	A6-626S.196.30	351,00	121	A6-636.196.30/DIMM 2-3	350,00	108
A6-626PL.168.40/DIMM 2-3	360,00	120	A6-626S.196.30/DIMM 2-3	384,00	121	A6-636.196.30/EM	457,00	108
A6-626PL.168								

CODICE	€ (IVA esclusa) / (VAT excluded)	P.	CODICE	€ (IVA esclusa) / (VAT excluded)	P.	CODICE	€ (IVA esclusa) / (VAT excluded)	P.
A6-636.196.40/EM	457,00	108	A6-660PL.140.30/DIMM 2-3.02-08	328,00	94	A6-660PL.2.084.30/DIMM 2-3.46	375,00	94
A6-636.224.30	340,00	108	A6-660PL.140.30/DIMM 2-3.46	368,00	94	A6-660PL.2.084.40.02-08	283,00	94
A6-636.224.30/DIMM 2-3	377,00	108	A6-660PL.140.40.02-08	300,00	94	A6-660PL.2.084.40.46	308,00	94
A6-636.224.30/EM	480,00	108	A6-660PL.140.40.46	340,00	94	A6-660PL.2.084.40/DIMM 2-3.02-08	350,00	94
A6-636.224.40	340,00	108	A6-660PL.140.40/DIMM 2-3.02-08	328,00	94	A6-660PL.2.084.40/DIMM 2-3.46	375,00	94
A6-636.224.40/DIMM 2-3	377,00	108	A6-660PL.140.40/DIMM 2-3.46	368,00	94	A6-660PL.2.112.30.02-08	340,00	94
A6-636.224.40/EM	480,00	108	A6-660PL.168.30.02-08	343,00	94	A6-660PL.2.112.30.46	370,00	94
A6-636.252.30	390,00	108	A6-660PL.168.30.46	398,00	94	A6-660PL.2.112.30/DIMM 2-3.02-08	400,00	94
A6-636.252.30/DIMM 2-3	424,00	108	A6-660PL.168.30/DIMM 2-3.02-08	375,00	94	A6-660PL.2.112.30/DIMM 2-3.46	430,00	94
A6-636.252.30/EM	530,00	108	A6-660PL.168.30/DIMM 2-3.46	430,00	94	A6-660PL.2.112.40.02-08	340,00	94
A6-636.252.40	390,00	108	A6-660PL.168.40.02-08	343,00	94	A6-660PL.2.112.40.46	370,00	94
A6-636.252.40/DIMM 2-3	424,00	108	A6-660PL.168.40.46	398,00	94	A6-660PL.2.112.40/DIMM 2-3.02-08	400,00	94
A6-636.252.40/EM	530,00	108	A6-660PL.168.40/DIMM 2-3.02-08	375,00	94	A6-660PL.2.112.40/DIMM 2-3.46	430,00	94
A6-636.280.30	430,00	108	A6-660PL.168.40/DIMM 2-3.46	430,00	94	A6-660PL.2.140.30.02-08	420,00	94
A6-636.280.30/DIMM 2-3	500,00	108	A6-660PL.196.30.02-08	394,00	94	A6-660PL.2.140.30.46	465,00	94
A6-636.280.30/EM	570,00	108	A6-660PL.196.30.46	454,00	94	A6-660PL.2.140.30/DIMM 2-3.02-08	480,00	94
A6-636.280.40	430,00	108	A6-660PL.196.30/DIMM 2-3.02-08	428,00	94	A6-660PL.2.140.30/DIMM 2-3.46	525,00	94
A6-636.280.40/DIMM 2-3	500,00	108	A6-660PL.196.30/DIMM 2-3.46	488,00	94	A6-660PL.2.140.40.02-08	420,00	94
A6-636.280.40/EM	570,00	108	A6-660PL.196.40.02-08	394,00	94	A6-660PL.2.140.40.46	465,00	94
A6-639.100.30	162,00	104	A6-660PL.196.40.46	454,00	94	A6-660PL.2.140.40/DIMM 2-3.02-08	480,00	94
A6-639.100.40	162,00	104	A6-660PL.196.40/DIMM 2-3.02-08	428,00	94	A6-660PL.2.140.40/DIMM 2-3.46	525,00	94
A6-641.100.30	179,00	124	A6-660PL.196.40/DIMM 2-3.46	488,00	94	A6-660PL.2.168.30.02-08	497,00	94
A6-641.100.40	179,00	124	A6-660PL.224.30.02-08	433,00	94	A6-660PL.2.168.30.46	547,00	94
A6-645.100.30	110,00	128	A6-660PL.224.30.46	503,00	94	A6-660PL.2.168.30/DIMM 2-3.02-08	550,00	94
A6-645.100.40	110,00	128	A6-660PL.224.30/DIMM 2-3.02-08	471,00	94	A6-660PL.2.168.30/DIMM 2-3.46	600,00	94
A6-646.100.30	117,00	128	A6-660PL.224.30/DIMM 2-3.46	541,00	94	A6-660PL.2.168.40.02-08	497,00	94
A6-646.100.40	117,00	128	A6-660PL.224.40.02-08	433,00	94	A6-660PL.2.168.40.46	547,00	94
A6-647.100.30	78,00	128	A6-660PL.224.40.46	503,00	94	A6-660PL.2.168.40/DIMM 2-3.02-08	550,00	94
A6-647.100.40	78,00	128	A6-660PL.224.40/DIMM 2-3.02-08	471,00	94	A6-660PL.2.168.40/DIMM 2-3.46	600,00	94
A6-648.100.30	85,00	128	A6-660PL.224.40/DIMM 2-3.46	541,00	94	A6-660PL.2.196.30.02-08	550,00	94
A6-648.100.40	85,00	128	A6-660PL.252.30.02-08	485,00	94	A6-660PL.2.196.30.46	610,00	94
A6-660PL.084.30.02-08	200,00	94	A6-660PL.252.30.46	560,00	94	A6-660PL.2.196.30/DIMM 2-3.02-08	610,00	94
A6-660PL.084.30.46	225,00	94	A6-660PL.252.30/DIMM 2-3.02-08	510,00	94	A6-660PL.2.196.30/DIMM 2-3.46	670,00	94
A6-660PL.084.30/DIMM 2-3.02-08	233,00	94	A6-660PL.252.30/DIMM 2-3.46	585,00	94	A6-660PL.2.196.40.02-08	550,00	94
A6-660PL.084.30/DIMM 2-3.46	258,00	94	A6-660PL.252.40.02-08	485,00	94	A6-660PL.2.196.40.46	610,00	94
A6-660PL.084.40.02-08	200,00	94	A6-660PL.252.40.46	560,00	94	A6-660PL.2.196.40/DIMM 2-3.02-08	610,00	94
A6-660PL.084.40.46	225,00	94	A6-660PL.252.40/DIMM 2-3.02-08	510,00	94	A6-660PL.2.196.40/DIMM 2-3.46	670,00	94
A6-660PL.084.40/DIMM 2-3.02-08	233,00	94	A6-660PL.252.40/DIMM 2-3.46	585,00	94	A6-660PL.2.224.30.02-08	600,00	94
A6-660PL.084.40/DIMM 2-3.46	258,00	94	A6-660PL.280.30.02-08	552,00	94	A6-660PL.2.224.30.46	670,00	94
A6-660PL.112.30.02-08	239,00	94	A6-660PL.280.30.46	637,00	94	A6-660PL.2.224.30/DIMM 2-3.02-08	667,00	94
A6-660PL.112.30.46	274,00	94	A6-660PL.280.30/DIMM 2-3.02-08	618,00	94	A6-660PL.2.224.30/DIMM 2-3.46	737,00	94
A6-660PL.112.30/DIMM 2-3.02-08	272,00	94	A6-660PL.280.30/DIMM 2-3.46	703,00	94	A6-660PL.2.224.40.02-08	600,00	94
A6-660PL.112.30/DIMM 2-3.46	307,00	94	A6-660PL.280.40.02-08	552,00	94	A6-660PL.2.224.40.46	670,00	94
A6-660PL.112.40.02-08	239,00	94	A6-660PL.280.40.46	637,00	94	A6-660PL.2.224.40/DIMM 2-3.02-08	667,00	94
A6-660PL.112.40.46	274,00	94	A6-660PL.280.40/DIMM 2-3.02-08	618,00	94	A6-660PL.2.224.40/DIMM 2-3.46	737,00	94
A6-660PL.112.40/DIMM 2-3.02-08	272,00	94	A6-660PL.280.40/DIMM 2-3.46	703,00	94	A6-660PL.2.252.30.02-08	680,00	94
A6-660PL.112.40/DIMM 2-3.46	307,00	94	A6-660PL.2.084.30.02-08	283,00	94	A6-660PL.2.252.30.46	755,00	94
A6-660PL.140.30.02-08	300,00	94	A6-660PL.2.084.30.46	308,00	94	A6-660PL.2.252.30/DIMM 2-3.02-08	738,00	94
A6-660PL.140.30.46	340,00	94	A6-660PL.2.084.30/DIMM 2-3.02-08	350,00	94	A6-660PL.2.252.30/DIMM 2-3.46	813,00	94

CODICE	€ (IVA esclusa) / (VAT excluded)	P.	CODICE	€ (IVA esclusa) / (VAT excluded)	P.	CODICE	€ (IVA esclusa) / (VAT excluded)	P.
A6-660PL.2.252.40.02-08	680,00	94	A6-660S.224.30.46	473,00	95	A6-660S.2.168.40/DIMM 2-3.02-08	517,00	95
A6-660PL.2.252.40.46	755,00	94	A6-660S.224.30/DIMM 2-3.02-08	443,00	95	A6-660S.2.168.40/DIMM 2-3.46	564,00	95
A6-660PL.2.252.40/DIMM 2-3.02-08	738,00	94	A6-660S.224.30/DIMM 2-3.46	509,00	95	A6-660S.2.196.30.02-08	517,00	95
A6-660PL.2.252.40/DIMM 2-3.46	813,00	94	A6-660S.224.40.02-08	407,00	95	A6-660S.2.196.30.46	573,00	95
A6-660PL.2.280.30.02-08	766,00	94	A6-660S.224.40.46	473,00	95	A6-660S.2.196.30/DIMM 2-3.02-08	573,00	95
A6-660PL.2.280.30.46	850,00	94	A6-660S.224.40/DIMM 2-3.02-08	443,00	95	A6-660S.2.196.30/DIMM 2-3.46	630,00	95
A6-660PL.2.280.30/DIMM 2-3.02-08	867,00	94	A6-660S.224.40/DIMM 2-3.46	509,00	95	A6-660S.2.196.40.02-08	517,00	95
A6-660PL.2.280.30/DIMM 2-3.46	951,00	94	A6-660S.252.30.02-08	456,00	95	A6-660S.2.196.40.46	573,00	95
A6-660PL.2.280.40.02-08	766,00	94	A6-660S.252.30.46	526,00	95	A6-660S.2.196.40/DIMM 2-3.02-08	573,00	95
A6-660PL.2.280.40.46	850,00	94	A6-660S.252.30/DIMM 2-3.02-08	480,00	95	A6-660S.2.196.40/DIMM 2-3.46	630,00	95
A6-660PL.2.280.40/DIMM 2-3.02-08	867,00	94	A6-660S.252.30/DIMM 2-3.46	550,00	95	A6-660S.2.224.30.02-08	564,00	95
A6-660PL.2.280.40/DIMM 2-3.46	951,00	94	A6-660S.252.40.02-08	456,00	95	A6-660S.2.224.30.46	630,00	95
A6-660S.084.30.02-08	188,00	95	A6-660S.252.40.46	526,00	95	A6-660S.2.224.30/DIMM 2-3.02-08	627,00	95
A6-660S.084.30.46	211,00	95	A6-660S.252.40/DIMM 2-3.02-08	480,00	95	A6-660S.2.224.30/DIMM 2-3.46	693,00	95
A6-660S.084.40.02-08	188,00	95	A6-660S.252.40/DIMM 2-3.46	550,00	95	A6-660S.2.224.40.02-08	564,00	95
A6-660S.084.40.46	211,00	95	A6-660S.280.30.02-08	519,00	95	A6-660S.2.224.40.46	630,00	95
A6-660S.112.30.02-08	225,00	95	A6-660S.280.30.46	600,00	95	A6-660S.2.224.40/DIMM 2-3.02-08	627,00	95
A6-660S.112.30.46	258,00	95	A6-660S.280.30/DIMM 2-3.02-08	581,00	95	A6-660S.2.224.40/DIMM 2-3.46	693,00	95
A6-660S.112.30/DIMM 2-3.02-08	256,00	95	A6-660S.280.30/DIMM 2-3.46	661,00	95	A6-660S.2.252.30.02-08	639,00	95
A6-660S.112.30/DIMM 2-3.46	289,00	95	A6-660S.280.40.02-08	519,00	95	A6-660S.2.252.30.46	710,00	95
A6-660S.112.40.02-08	225,00	95	A6-660S.280.40.46	600,00	95	A6-660S.2.252.30/DIMM 2-3.02-08	694,00	95
A6-660S.112.40.46	258,00	95	A6-660S.280.40/DIMM 2-3.02-08	581,00	95	A6-660S.2.252.30/DIMM 2-3.46	764,00	95
A6-660S.112.40/DIMM 2-3.02-08	256,00	95	A6-660S.280.40/DIMM 2-3.46	661,00	95	A6-660S.2.252.40.02-08	639,00	95
A6-660S.112.40/DIMM 2-3.46	289,00	95	A6-660S.2.084.30.02-08	266,00	95	A6-660S.2.252.40.46	710,00	95
A6-660S.140.30.02-08	282,00	95	A6-660S.2.084.30.46	290,00	95	A6-660S.2.252.40/DIMM 2-3.02-08	694,00	95
A6-660S.140.30.46	320,00	95	A6-660S.2.084.40.02-08	266,00	95	A6-660S.2.252.40/DIMM 2-3.46	764,00	95
A6-660S.140.30/DIMM 2-3.02-08	308,00	95	A6-660S.2.084.40.46	290,00	95	A6-660S.2.252.40/DIMM 2-3.02-08	720,00	95
A6-660S.140.30/DIMM 2-3.46	346,00	95	A6-660S.2.084.40.46	290,00	95	A6-660S.2.280.30.02-08	799,00	95
A6-660S.140.40.02-08	282,00	95	A6-660S.2.112.30.02-08	320,00	95	A6-660S.2.280.30.46	799,00	95
A6-660S.140.40.46	320,00	95	A6-660S.2.112.30.02-08	376,00	95	A6-660S.2.280.30/DIMM 2-3.02-08	815,00	95
A6-660S.140.40/DIMM 2-3.02-08	308,00	95	A6-660S.2.112.30/DIMM 2-3.02-08	376,00	95	A6-660S.2.280.30/DIMM 2-3.46	894,00	95
A6-660S.140.40/DIMM 2-3.46	346,00	95	A6-660S.2.112.40.02-08	320,00	95	A6-660S.2.280.40.02-08	720,00	95
A6-660S.168.30.02-08	322,00	95	A6-660S.2.112.40.46	348,00	95	A6-660S.2.280.40.46	799,00	95
A6-660S.168.30.46	374,00	95	A6-660S.2.112.40/DIMM 2-3.02-08	376,00	95	A6-660S.2.280.40/DIMM 2-3.02-08	815,00	95
A6-660S.168.30/DIMM 2-3.02-08	352,00	95	A6-660S.2.112.40/DIMM 2-3.46	404,00	95	A6-660S.2.280.40/DIMM 2-3.46	894,00	95
A6-660S.168.30/DIMM 2-3.46	404,00	95	A6-660S.2.140.30.02-08	395,00	95	<b>A7</b>		
A6-660S.168.40.02-08	322,00	95	A6-660S.2.140.30.46	437,00	95	A7-000	8,00	131
A6-660S.168.40.46	374,00	95	A6-660S.2.140.30/DIMM 2-3.02-08	451,00	95	A7-000.2	8,00	131
A6-660S.168.40/DIMM 2-3.02-08	352,00	95	A6-660S.2.140.30/DIMM 2-3.46	494,00	95	A7-002	30,00	131
A6-660S.168								

CODICE	€ (IVA esclusa) / (VAT excluded)	P.	CODICE	€ (IVA esclusa) / (VAT excluded)	P.	CODICE	€ (IVA esclusa) / (VAT excluded)	P.
A7-603.F100.40	88,00	132	A8-641.15.30	290,00	26	A8-660S.112.30/DIMM 2-3.46	456,00	34
A7-603.L100.30	136,00	133	A8-641.15.40	290,00	26	A8-660S.112.40.02-08	370,00	34
A7-603.L100.40	136,00	133	A8-641.20.30	300,00	26	A8-660S.112.40.46	425,00	34
A7-604.A100.30	95,00	132	A8-641.20.40	300,00	26	A8-660S.112.40/DIMM 2-3.02-08	402,00	34
A7-604.A100.40	95,00	132	A8-645.25.30	295,00	26	A8-660S.112.40/DIMM 2-3.46	456,00	34
A7-604.F100.30	95,00	132	A8-645.25.40	295,00	26	A8-660S.140.30.02-08	426,00	34
A7-604.F100.40	95,00	132	A8-646.35.30	315,00	26	A8-660S.140.30.46	484,00	34
A7-604.L100.30	150,00	133	A8-646.35.40	315,00	26	A8-660S.140.30/DIMM 2-3.02-08	455,00	34
A7-604.L100.40	150,00	133	A8-648.2.30	395,00	27	A8-660S.140.30/DIMM 2-3.46	510,00	34
A7-608.100.30	118,00	131	A8-648.2.40	395,00	27	A8-660S.140.40.02-08	426,00	34
A7-608.100.40	118,00	131	A8-650.050.30	185,00	28	A8-660S.140.40.46	484,00	34
A7-608.2.100.30	169,00	131	A8-650.050.40	185,00	28	A8-660S.140.40/DIMM 2-3.02-08	455,00	34
A7-608.2.100.40	169,00	131	A8-650.100.30	205,00	28	A8-660S.140.40/DIMM 2-3.46	510,00	34
A7-609.100.30	125,00	131	A8-650.100.40	205,00	28	A8-660S.2.112.30.02-08	465,00	34
A7-609.100.40	125,00	131	A8-660PL.112.30.02-08	390,00	32	A8-660S.2.112.30.46	513,00	34
A7-609.2.100.30	183,00	131	A8-660PL.112.30.46	445,00	32	A8-660S.2.112.30/DIMM 2-3.02-08	522,00	34
A7-609.2.100.40	183,00	131	A8-660PL.112.30/DIMM 2-3.02-08	423,00	32	A8-660S.2.112.30/DIMM 2-3.46	570,00	34
			A8-660PL.112.30/DIMM 2-3.46	480,00	32	A8-660S.2.112.40.02-08	465,00	34
			A8-660PL.112.40.02-08	390,00	32	A8-660S.2.112.40.46	513,00	34
<b>A8</b>			A8-660PL.112.40.46	445,00	32	A8-660S.2.112.40/DIMM 2-3.02-08	522,00	34
A8-604.120.30	220,00	31	A8-660PL.112.40/DIMM 2-3.02-08	423,00	32	A8-660S.2.112.40/DIMM 2-3.46	570,00	34
A8-604.120.40	220,00	31	A8-660PL.140.30.02-08	450,00	32	A8-660S.2.140.30.02-08	540,00	34
A8-604.150.30	240,00	31	A8-660PL.140.30.46	510,00	32	A8-660S.2.140.30.46	600,00	34
A8-604.150.40	240,00	31	A8-660PL.140.40.02-08	480,00	32	A8-660S.2.140.30/DIMM 2-3.02-08	598,00	34
A8-606.2.112.30	425,00	37	A8-660PL.140.40.46	540,00	32	A8-660S.2.140.30/DIMM 2-3.46	660,00	34
A8-606.2.112.30/DIMM 2-3	506,00	37	A8-660PL.140.40.02-08	450,00	32	A8-660S.2.140.40.02-08	540,00	34
A8-606.2.112.40	425,00	37	A8-660PL.140.40.46	510,00	32	A8-660S.2.140.40.46	600,00	34
A8-606.2.112.40/DIMM 2-3	506,00	37	A8-660PL.140.40/DIMM 2-3.02-08	480,00	32	A8-660S.2.140.40/DIMM 2-3.02-08	598,00	34
A8-606.2.140.30	496,00	37	A8-660PL.140.40/DIMM 2-3.46	540,00	32	A8-660S.2.140.40/DIMM 2-3.46	660,00	34
A8-606.2.140.30/DIMM 2-3	579,00	37	A8-660PL.2.112.30.02-08	490,00	32			
A8-606.2.140.40	496,00	37	A8-660PL.2.112.30.46	540,00	32	<b>A9</b>		
A8-606.2.140.40/DIMM 2-3	579,00	37	A8-660PL.2.112.30/DIMM 2-3.02-08	550,00	32	A9-613.30	180,00	17
A8-607.2.112.30	510,00	37	A8-660PL.2.112.30/DIMM 2-3.46	600,00	32	A9-613.40	180,00	17
A8-607.2.112.30/DIMM 2-3	580,00	37	A8-660PL.2.112.40.02-08	490,00	32	A9-616.2.028.30	210,00	20
A8-607.2.112.40	510,00	37	A8-660PL.2.112.40.46	540,00	32	A9-616.2.028.40	210,00	20
A8-607.2.112.40/DIMM 2-3	580,00	37	A8-660PL.2.112.40.02-08	490,00	32	A9-616.2.056.30	265,00	20
A8-607.2.140.30	590,00	37	A8-660PL.2.112.40.46	540,00	32	A9-616.2.056.30/DIMM 2-3	330,00	20
A8-607.2.140.30/DIMM 2-3	670,00	37	A8-660PL.2.140.30.02-08	630,00	32	A9-616.2.056.40	265,00	20
A8-607.2.140.40	590,00	37	A8-660PL.2.140.30.46	695,00	32	A9-616.2.056.40/DIMM 2-3	330,00	20
A8-607.2.140.40/DIMM 2-3	670,00	37	A8-660PL.2.140.40.02-08	570,00	32	A9-616.2.084.30	330,00	20
A8-630.036.30	470,00	31	A8-660PL.2.140.40.46	635,00	32	A9-616.2.084.30/DIMM 2-3	395,00	20
A8-630.036.30/DIMM 2-3	510,00	31	A8-660PL.2.140.40/DIMM 2-3.02-08	630,00	32	A9-616.2.084.40	330,00	20
A8-630.036.40	470,00	31	A8-660PL.2.140.40/DIMM 2-3.46	695,00	32	A9-616.2.084.40/DIMM 2-3	395,00	20
A8-630.036.40/DIMM 2-3	510,00	31	A8-660PL.2.140.40.02-08	570,00	32	A9-616.2.112.30	380,00	20
A8-631.048.30	535,00	31	A8-660PL.2.140.40.46	635,00	32	A9-616.2.112.30/DIMM 2-3	450,00	20
A8-631.048.30/DIMM 2-3	595,00	31	A8-660PL.2.140.40/DIMM 2-3.02-08	630,00	32	A9-616.2.112.40	380,00	20
A8-631.048.40	535,00	31	A8-660PL.2.140.40/DIMM 2-3.46	695,00	32	A9-616.2.112.40/DIMM 2-3	450,00	20
A8-631.048.40/DIMM 2-3	595,00	31	A8-660S.112.30.02-08	370,00	34	A9-617.2.028.30	245,00	20
A8-640.13.30	279,00	26	A8-660S.112.30.46	425,00	34	A9-617.2.028.40	245,00	20
A8-640.13.40	279,00	26	A8-660S.112.30/DIMM 2-3.02-08	402,00	34			

CODICE	€ (IVA esclusa) / (VAT excluded)	P.	CODICE	€ (IVA esclusa) / (VAT excluded)	P.
A9-617.2.056.30	295,00	20	PA 020-24	-	57
A9-617.2.056.30/DIMM 2-3	348,00	20	PA 021-20	-	69-70
A9-617.2.056.40	295,00	20	PA 022-20	-	40-41
A9-617.2.056.40/DIMM 2-3	348,00	20		-	44-80
A9-617.2.084.30	425,00	20	PA 023-15	-	42-43-81
A9-617.2.084.30/DIMM 2-3	490,00	20	PA 023-50	-	42-43-81
A9-617.2.084.40	425,00	20	PA 024-22	-	73
A9-617.2.084.40/DIMM 2-3	490,00	20	PA 025-20	-	13
A9-617.2.112.30	470,00	20	PA 026-35	-	76
A9-617.2.112.30/DIMM 2-3	560,00	20	STR50012120.30	84,00	135
A9-617.2.112.40	470,00	20	STR50012120.40	84,00	135
A9-617.2.112.40/DIMM 2-3	560,00	20	STR50025280.30	110,00	135
A9-620.30	195,00	14	STR50025280.40	110,00	135
A9-620.40	195,00	14	T	15,00	110
A9-621.30	290,00	14	T002	vedi pag. 32-34-94 see page 95-98	
A9-621.40	290,00	14	T008	vedi pag. 32-34-94 see page 95-98	
A9-626.30	280,00	15	T013	vedi pag. 32-34-94 see page 95-98	
A9-626.40	280,00	15	TT	30,00	110
A9-628.30	160,00	16	W	50,00	110-111 122-123 124
A9-650.30	115,00	11	X	25,00	110-111 122-123 124
A9-651.30	89,00	11	Y	25,00	110-111 122-123 124
A9-652.30	139,00	12	Z	50,00	110-111 122-123 124
A9-654.30	120,00	12			
A9-660.30	149,00	10			
ESAL100A	24,00	134			
ESAL100F	20,00	134			
ESAL100L	29,00	134			
ESAL200A	35,00	134			
ESAL200F	30,00	134			
ESAL200L	44,00	134			
K	50,00	110-111 122-123 124			
LE001-30/100	15,00	20-37 100-103 104-108 110-111			
LE002-25	-	90			
LE003-15	-	88			
PA 010-20	-	8-26			
PA 011-16	-	8-26			
PA 014-24	-	18-19-49 51-58-59			
PA 017-15	-	52-53			
PA 017-24	-	52-53			
PA 018-15	-	56			
PA 018-24	-	56			
PA 019-15	-	56			
PA 019-24	-	56			
PA 020-15	-	57			





**Headquarter**

Via delle Industrie 14  
20874 Busnago (MB) Italy  
Tel. +39 039 6095574  
Fax. +39 039 6095576

**Ufficio Vendite Italia**

Tel. +39 039 6095574  
venditeitalia@aqlus.it

**Export Sales Dept.**

Tel. +39 039 6095575  
export@aqlus.it

**Reparto Tecnico**

tecnico@aqlus.it

# Aqlus

a brand of Biffi Luce S.R.L.

[www.aqlus.com](http://www.aqlus.com)  
[aqlus@aqlus.it](mailto:aqlus@aqlus.it)