

paullucco

Alle Preise zzgl. ges. MwSt.

pricelist 2022

lampade / lamps

lampade sospensione / hanging lamps

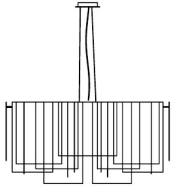

alexandra
p. 23

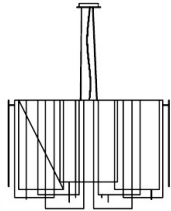

alexandra long
p. 24



coral
p. 18



crinolina
p. 19

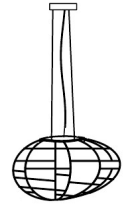

egg
p. 20

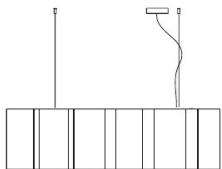

fold
p. 17



glow
p. 16

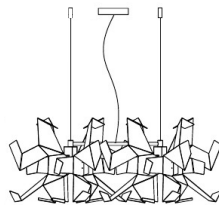

glow pendant 2
p. 16

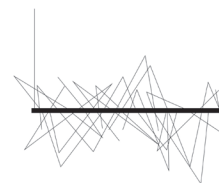

graffiti
p. 29

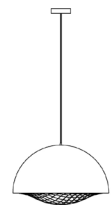

grid
p. 27

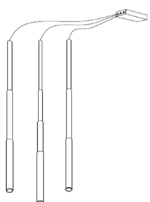

micro telescopic
p. 34

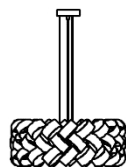

ring
p. 25

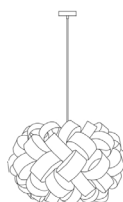

ring sphere
p. 26

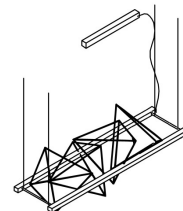

rock garden
p. 21



rock garden spot
p. 22

lampade / lamps

lampade da terra / floor lamps



baby gilda
p. 14



calla
p. 33



coral
p. 18



egg
p. 20



faro next
p. 15



fortuný
p. 10



fortuný petite
p. 11



gilda
p. 13



micro telescopic
p. 34



papiro
p. 12

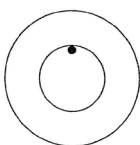

rainy day
p. 30

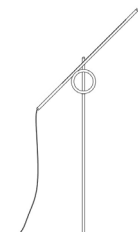

tangent
p. 40



tube
p. 45

lampade / lamps

lampade da tavolo / table lamps



coral
p. 18



egg
p. 20

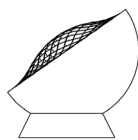

grid
p. 27

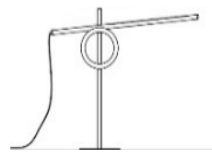

tangent
p. 40

lampade applique / wall lamps



fold
p. 17

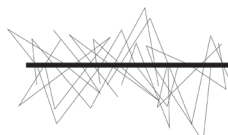

graffiti
p. 29

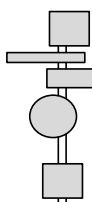

totem
p. 41

contenitori / container cabinets

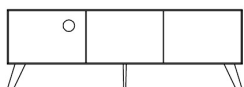

next basic
p. 47

librerie / bookcases

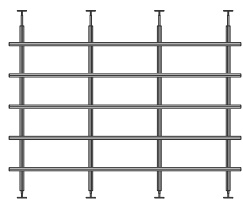

continua
p. 48

accessori / accessories

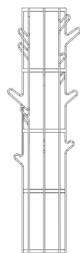

albero
p. 60



lagronda
p. 61

pallucco

Listino di vendita al pubblico 2022
Public Price List 2022

IVA ESCLUSA
VAT NOT INCLUDED

italiano / english

**indice generale
index****lampade
lamps**

Fortuny	pag.	10
Fortuny Petite	pag.	11
Papiro	pag.	12
Gilda	pag.	13
Faro Next	pag.	15
Glow	pag.	16
Fold	pag.	17
Coral	pag.	18
Crinolina	pag.	19
Egg	pag.	20
Rock Garden	pag.	21
Alexandra	pag.	23
Ring	pag.	25
Grid	pag.	27
Graffiti	pag.	29
Rainy Day	pag.	32
Calla	pag.	33
Micro Telescopic	pag.	34
Tangent	pag.	40
Totem	pag.	41
Tube 2.0	pag.	45

**contenitori
container cabinets**

Next Basic	pag.	47
------------	------	----

**librerie
bookcases**

Continua	pag.	48
----------	------	----

**accessori
accessories**

Albero	pag.	60
LaGronda	pag.	61

**pesi e volumi
weight and volumes**

pag.	62
------	----

**condizioni di vendita
sales conditions**

pag.	66
------	----

legenda

pag.	66
------	----

lampade / lamps

Nome Name	Struttura Frame	Diffusore / Diffuser		Codice Code	EURO
		Tessuto esterno External fabric	Tessuto interno Internal fabric		
	nero / black	cotone nero black cotton	cotone bianco white cotton	LAM 101 0 09956	3.690
	MODA titanio / titanium	cotone beige beige cotton	cotone bianco white cotton	LAM 101 0 09957	3.690
	BLANCA bianco / white	cotone bianco white cotton	cotone bianco white cotton	LAM 101 0 700W	3.690
	KIEFFER- RUBELLI nero / black	taffetas plissé nero black taffetas plissé	lino metallico oro gold metallic linen	LAM 101 0 18779	3.990
	BRONZE RUBELLI nero / black	semilucido nero tipo "Raffia" semi gloss black "Raffia Style"	lino metallico bronzo bronze metallic linen	LAM 101 0 20779	3.990
SILVER RUBELLI nero / black	semilucido nero tipo "Raffia" semi gloss black "Raffia Style"	argento metallico metallic silver	LAM101 0 20565	3.990	

pezzi di ricambio - spare parts

lampadina 300W - E40
light bulb 300W - E40 € 48

varialuce
dimmer € 90



1 lampadina LED 21W
2700K 2500lm dimmerabile
1 lampadina ad incandescenza
300W E40 3630lm
Dimmer

1 LED 21W
2700K 2500lm dimmable
1 incandescent light bulb
300W E40 3630lm
Dimmer

lampade / lamps

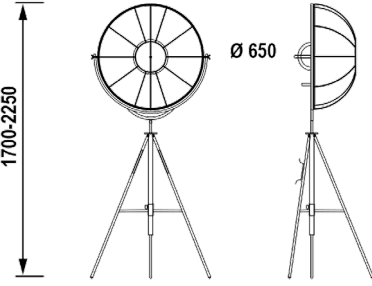
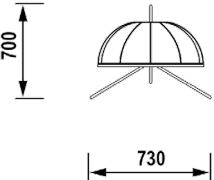
Nome Name	Struttura Frame	Diffusore / Diffuser		Codice Code	EURO
		Tessuto esterno External fabric	Tessuto interno Internal fabric		
	nero / black	cotone nero black cotton	cotone bianco white cotton	LAM 201 0 09956	3.135
	MODA titanio / titanium	cotone beige beige cotton	cotone bianco white cotton	LAM 201 0 09957	3.135
	BLANCA bianco / white	cotone bianco white cotton	cotone bianco white cotton	LAM 201 0 700W	3.135
	KIEFFER- RUBELLI nero / black	taffetas plissé nero black taffetas plissé	lino metallico oro gold metallic linen	LAM 201 0 18779	3.330
	BRONZE RUBELLI nero / black	semilucido nero tipo "Raffia" semi gloss black "Raffia Style"	lino metallico bronzo bronze metallic linen	LAM 201 0 20779	3.330
	SILVER RUBELLI nero / black	semilucido nero tipo "Raffia" semi gloss black "Raffia Style"	argento metallico metallic silver	LAM 201 0 20579	3.330

pezzi di ricambio - spare parts

lampadina 300W - E40
light bulb 300W - E40 € 48

varialuce
dimmer € 90



1 lampadina LED 21W
2700K 2500lm dimmerabile
1 lampadina ad incandescenza
300W E40 3630lm
Dimmer

1 LED 21W
2700K 2500lm dimmable
1 incandescent light bulb
300W E40 3630lm
Dimmer

lampade / lamps

Nome Name	Struttura Frame	Altezza Height	Codice Code	EURO
--------------	--------------------	-------------------	----------------	------

PAPIRO LED 2200 TERRA / FLOOR

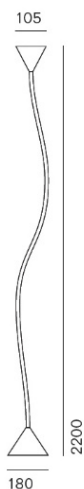

rame / copper	2200 mm	LAM 102 5 09922	935
nichel / nickel	2200 mm	LAM 102 5 09923	935
oro perlato / pearl gold	2200 mm	LAM 102 5 17015	935

pezzi di ricambio - spare parts

alimentatore dimmerabile
dimmable ballast € 90

Modulo LED
15W – light source 380mA 13W
2700 K – 1190 lm
IP20

LED Module
15W – light source 380mA 13W
2700 K – 1190 lm
IP20



PAPIRO LED 2700 TERRA / FLOOR



rame / copper	2700 mm	LAM 102 6 09922	979
nichel / nickel	2700 mm	LAM 102 6 09923	979
oro perlato / pearl gold	2700 mm	LAM 102 6 17015	979

pezzi di ricambio - spare parts

alimentatore dimmerabile
dimmable ballast € 90

Modulo LED
15W – light source 380mA 13W
2700 K – 1190 lm
IP20

LED Module
15W – light source 380mA 13W
2700 K – 1190 lm
IP20

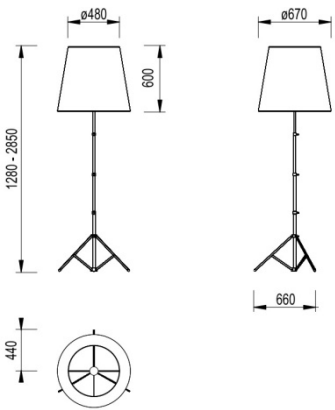

lampade / lamps

Nome Name	Struttura Frame	Diffusore Diffuser	Codice Code	EURO										
GILDA														
	alluminio naturale natural aluminium	Carta pergamena sintetica Synthetic parchment paper												
		bianco / white avorio / ivory	LAM 110 0 09938 LAM 110 0 09941	800 800										
	alluminio naturale natural aluminium	Juta / Organic jute												
		naturale / natural nero / black bianco / white	LAM 110 0 15918 LAM 110 0 15919 LAM 110 0 18462	800 800 800										
<table border="1"> <thead> <tr> <th colspan="2">pezzi di ricambio - spare parts</th> </tr> </thead> <tbody> <tr> <td>diffusore pergamena/juta parchment/jute diffuser</td> <td>€ 400</td> </tr> <tr> <td>diffusore plissé plissé diffuser</td> <td>€ 500</td> </tr> <tr> <td>cavalletto con varialuce tripod with dimmer</td> <td>€ 400</td> </tr> <tr> <td>varialuce dimmer</td> <td>€ 90</td> </tr> </tbody> </table>					pezzi di ricambio - spare parts		diffusore pergamena/juta parchment/jute diffuser	€ 400	diffusore plissé plissé diffuser	€ 500	cavalletto con varialuce tripod with dimmer	€ 400	varialuce dimmer	€ 90
pezzi di ricambio - spare parts														
diffusore pergamena/juta parchment/jute diffuser	€ 400													
diffusore plissé plissé diffuser	€ 500													
cavalletto con varialuce tripod with dimmer	€ 400													
varialuce dimmer	€ 90													
	alluminio naturale natural aluminium	Plissé / Pongè	<i>Versione ignifuga su richiesta</i> <i>Fire retardant version on request</i>											
		bianco / white avorio / ivory	LAM 110 0 19722 LAM 110 0 19721	900 900										
	Lampadine consigliate: 1 max 205W E27 alogena 1 max 21W E27 LED IP20	Suggested light bulbs: 1 max 205W E27 halogene 1 max 21W E27 LED IP20												

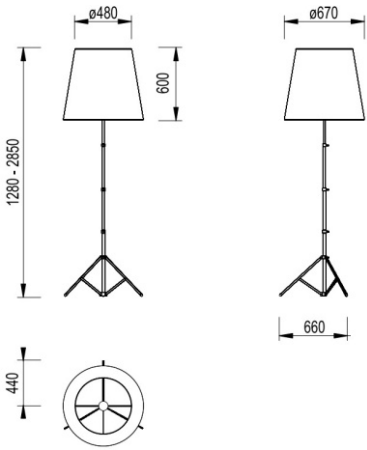

GILDA BLACK

	alluminio nero opaco matt black aluminium	juta / organic jute nero / black	LAM 110 0 20447	870								
	<table border="1"> <thead> <tr> <th colspan="2">pezzi di ricambio - spare parts</th> </tr> </thead> <tbody> <tr> <td>diffusore diffuser</td> <td>€ 400</td> </tr> <tr> <td>cavalletto con varialuce tripod with dimmer</td> <td>€ 470</td> </tr> <tr> <td>varialuce dimmer</td> <td>€ 90</td> </tr> </tbody> </table>					pezzi di ricambio - spare parts		diffusore diffuser	€ 400	cavalletto con varialuce tripod with dimmer	€ 470	varialuce dimmer
pezzi di ricambio - spare parts												
diffusore diffuser	€ 400											
cavalletto con varialuce tripod with dimmer	€ 470											
varialuce dimmer	€ 90											
	Lampadine consigliate: 1 max 205W E27 alogena 1 max 21W E27 LED IP20	Suggested light bulbs: 1 max 205W E27 halogene 1 max 21W E27 LED IP20										



lampade / lamps

Nome Name	Struttura Frame	Diffusore Diffuser	Codice Code	EURO
--------------	--------------------	-----------------------	----------------	------

BABY GILDA

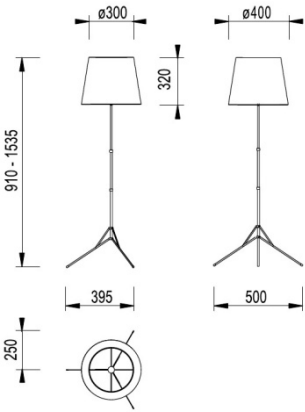

metallo nichelato
nickel - plated metal

Carta pergamena sintetica
Synthetic parchment paper

bianco / white
avorio / ivory

GIB 001 0 18122
GIB 001 0 18123

405
405

metallo nichelato
nickel - plated metal

Juta / Organic jute

naturale / natural
nero / black
bianco / white

GIB 001 0 18124
GIB 001 0 18125
GIB 001 0 18484

405
405
405

pezzi di ricambio - spare parts

diffusore pergamena/juta
parchment/jute diffuser € 203

diffusore plissé
plissé diffuser € 258

cavalletto con varialuce
tripod with dimmer € 202

varialuce
dimmer € 90

metallo nichelato
nickel - plated metal

Plissé / Pongè

bianco / white
avorio / ivory

Versione ignifuga su richiesta
Fire retardant version on request

GIB 001 0 19728
GIB 001 0 19727

460
460

Lampadine consigliate:
1 max 150W E27 alogena
1 max 21W E27 LED
IP20

Suggested light bulbs:
1 max 150W E27 halogene
1 max 21W E27 LED
IP20



lampade / lamps

Nome Name	Struttura Frame	Diffusore Diffuser	Codice Code	EURO
--------------	--------------------	-----------------------	----------------	------

FARO NEXT

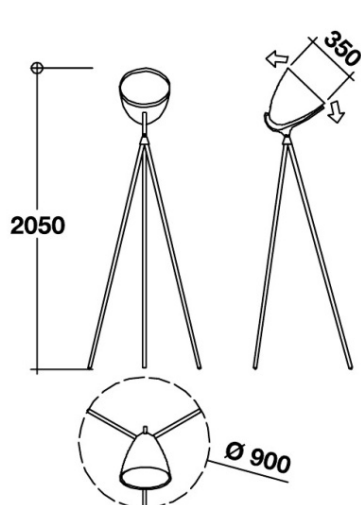

rovere tinto bianco opaco matt white varnished oak wood	alluminio verniciato bianco opaco matt white lacquered aluminium	FAR 03 0 20457	1.890
rovere tinto nero opaco matt black varnished oak wood	alluminio verniciato nero opaco matt black lacquered aluminium	FAR 03 0 20459	1.890
rovere naturale verniciato trasparente transparent varnished natural oak wood	alluminio verniciato bianco opaco matt white lacquered aluminium	FAR 03 0 20461	1.890
rovere naturale verniciato trasparente transparent varnished natural oak wood	alluminio verniciato nero opaco matt black lacquered aluminium	FAR 03 0 20463	1.890

CE

Lampadina consigliata:
1 alogena max 205W E27
Dimmer

Suggested light bulb:
1 halogene max 205W E27
Dimmer

FARO NEXT LED

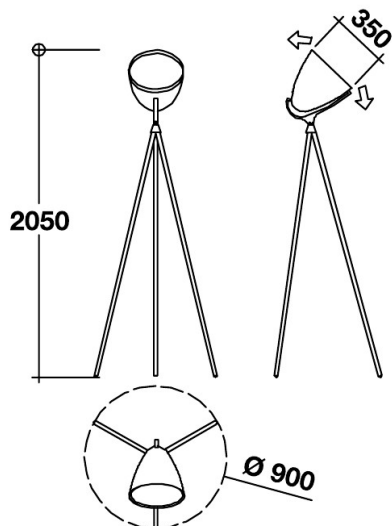

rovere tinto bianco opaco matt white varnished oak wood	alluminio verniciato bianco opaco matt white lacquered aluminium	FAR 03 5 20457	2.190
rovere tinto nero opaco matt black varnished oak wood	alluminio verniciato nero opaco matt black lacquered aluminium	FAR 03 5 20459	2.190
rovere naturale verniciato trasparente transparent varnished natural oak wood	alluminio verniciato bianco opaco matt white lacquered aluminium	FAR 03 5 20461	2.190
rovere naturale verniciato trasparente transparent varnished natural oak wood	alluminio verniciato nero opaco matt black lacquered aluminium	FAR 03 5 20463	2.190

CE

1 LED di potenza
25,4W 3000K 4328lm
Dimmer

1 power LED
25,4W 3000K 4328lm
Dimmer

lampade / lamps

Nome Name	Struttura Frame	Finitura diffusore Diffuser finishes	Codice Code	EURO
--------------	--------------------	---	----------------	------

GLOW SOSPENSIONE 1 / PENDANT 1

rosone cromo lucido e cavo in acciaio

high gloss chrome ceiling plate and steel cables

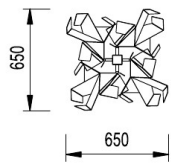
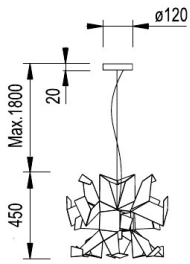

acciaio bianco semilucido
semigloss white steel

GLO 011 016224 910

alluminio satinato
satin finish aluminum

* GLO 011 016225 1.230

ottone satinato e brunito
burnished and satined brass

GLO 011 016226 2.400

acciaio rosso semilucido
semi gloss red steel

* GLO 011 017693 910

CE

Lampadine consigliate:
1 alogena max 205W E27
1 LED 21W E27

Suggested light bulbs:
1 halogene max 205W E27
1 LED 21W E27

GLOW SOSPENSIONE 2 / PENDANT 2

barra in acciaio e rosone cromo lucido, cavo in acciaio

high gloss chrome steel rod and ceiling plate, steel cable

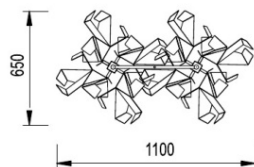
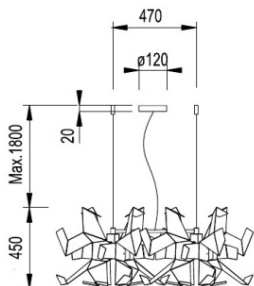

acciaio bianco semilucido
semigloss white steel

GLO 012 016224 1.690

alluminio satinato
satin finish aluminum

* GLO 012 016225 2.290

ottone satinato e brunito
burnished and satined brass

GLO 012 016226 4.490

acciaio rosso semilucido
semi gloss redsteel

* GLO 012 017693 1.690

CE

Lampadine consigliate:
2 alogene max 205W E27
2 LED 21W E27

Suggested light bulbs:
2 halogene max 205W E27
2 LED 21W E27

* Ad esaurimento scorte
Until quantities last

lampade / lamps

Nome Name	Struttura Frame	Finitura corpo lampada Lamp finishes	Codice Code	EURO
FOLD SOSPENSIONE MEDIA MEDIUM PENDANT	rosone cromato lucido high-gloss chrome ceiling plate	acciaio inox a specchio e interno bianco super-mirror stainless steel lacquered white inside Diffusore metacrilato opalino / Opale metarylate	FOL 012 0 18350	1.320
	Lampadine consigliate: 2 fluorescenti lineari T5 24W/830 G5	Suggested light bulbs: linear fluorescent T5 24W/830 G5		
FOLD SOSPENSIONE GRANDE LARGE PENDANT	rosone cromato lucido high-gloss chrome ceiling plate	acciaio inox a specchio e interno bianco super-mirror stainless steel lacquered white inside Diffusore metacrilato opalino / Opale metarylate	FOL 013 0 18350	1.720
	Lampadine consigliate: 2 fluorescenti lineari T5 54W/830 G5	Suggested light bulbs: linear fluorescent T5 54W/830 G5		
FOLD APPLIQUE PICCOLA SMALL APPLIQUE		acciaio inox a specchio e interno bianco super-mirror stainless steel lacquered white inside Diffusore metacrilato opalino / Opale metarylate	FOL 021 0 18353	670
	Lampadine consigliate: 2 fluorescenti 30W E27 2 LED 21W E27	Suggested light bulbs: 2 fluorescent 30W E27 2 LED 21W E27		

lampade / lamps

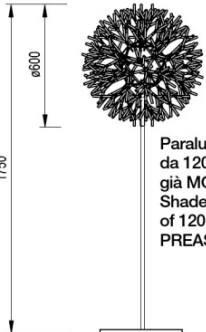
Nome Name	Struttura Frame	Diffusore Diffuser	Codice Code	EURO
CORAL PIANTANA Ø 600 FLOOR Ø 600				
 <p>Paralume composto da 120 rametti già MONTATI / Shade made of 120 branches PREASSEMBLED</p>	metallo verniciato opaco matt lacquered metal	ABS stampato iniezione injection moulded ABS		
	bianco opaco matt white	bianco / arancio fluo white / orange fluo	COR 011 019341	1.450
	avorio opaco matt Ivory	avorio / rosso ivory / red	COR 011 019340	1.450
	nero grigio opaco matt black grey	nero grigio / avorio black grey / ivory	COR 011 019343	1.450
	<ul style="list-style-type: none"> Tutte le versioni sono dotate di diffusore cilindrico in vetro bianco soffiato All versions are equipped with white blown glass internal diffuser 			
	Lampadine consigliate: 1 alogena eco max 105W E27 1 fluorescente 33W E27 dimmerabile 1 LED 21W E27 dimmerabile Dimmer	Suggested light bulbs: 1 halogene eco max 105W E27 1 fluorescent 33W E27 dimmable 1 LED 21W E27 dimmable Dimmer		

CORAL SOSPENSIONE Ø 600 PENDANT Ø 600

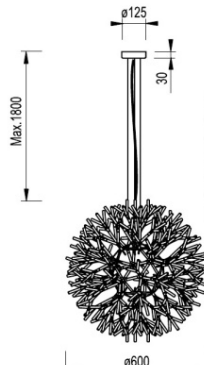
 <p>Paralume composto da 120 rametti già MONTATI / Shade made of 120 branches PREASSEMBLED</p>	metallo verniciato opaco matt lacquered metal	ABS stampato iniezione Injection moulded ABS		
	bianco opaco matt white	bianco / arancio fluo white / orange fluo	COR 101 019344	990
	avorio opaco matt Ivory	avorio / rosso ivory / red	COR 101 019346	990
	nero grigio opaco matt black grey	nero grigio / avorio black grey / ivory	COR 101 019347	990
	<ul style="list-style-type: none"> Tutte le versioni sono dotate di diffusore cilindrico in vetro bianco soffiato All versions are equipped with white blown glass internal diffuser 			
	Lampadine consigliate: 1 alogena eco max 77W E27 1 fluorescente 20W E27 1 LED 21W E27	Suggested light bulbs: 1 halogene eco max 77W E27 1 fluorescent 20W E27 1 LED 21W E27		

CORAL TERRA - TAVOLO Ø 600 CORAL FLOOR - TABLE Ø 600

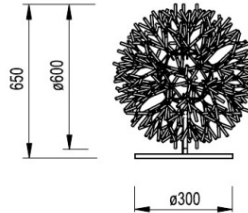
 <p>Paralume composto da 120 rametti già MONTATI / Shade made of 120 branches PREASSEMBLED</p>	metallo verniciato opaco matt lacquered metal	ABS stampato iniezione injection moulded ABS		
	bianco opaco matt white	bianco / arancio fluo white / orange fluo	COR 001 019341	1.220
	avorio opaco matt ivory	avorio / rosso ivory / red	COR 001 019340	1.220
	nero grigio opaco matt black grey	nero grigio /avorio black grey /ivory	COR 001 019343	1.220
	<ul style="list-style-type: none"> Tutte le versioni sono dotate di diffusore cilindrico in vetro bianco soffiato All versions are equipped with white blown glass internal diffuser 			
	Lampadine consigliate: 1 alogena eco max 77W E27 1 fluorescente 20W E27 dimmerabile 1 LED 21W E27 dimmerabile Dimmer	Suggested light bulbs: 1 halogene eco max 77W E27 1 fluorescent 20W E27 dimmable 1 LED 21W E27 dimmable Dimmer		

lampade / lamps

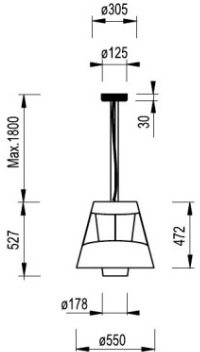
Nome Name	Struttura Frame	Diffusore Diffuser	Codice Code	EURO
CRINOLINA SOSPENSIONE Ø 550 PENDANT Ø 550				
	metallo verniciato bianco opaco matt white lacquered metal	cotone cinzato accoppiato a PVC / chinzed cotton fabric coupled with PVC		
	bianco opaco matt white	esterno bianco interno oro external white internal gold	CRI 101 019370	1.150
	antracite opaco matt anthracite	esterno antracite interno oro external anthracite internal gold	CRI 101 019369	1.150



Lampadine consigliate:
 2 alogene eco max 77W E27
 2 fluorescenti 30W E27
 2 LED 21W E27

Suggested light bulbs:
 2 halogene eco max 77W E27
 2 fluorescent 30W E27
 2 LED 21W E27

lampade / lamps

Nome Name	Struttura Frame	Diffusore Diffuser	Codice Code	EURO
--------------	--------------------	-----------------------	----------------	------

EGG TAVOLO TABLE

vetro soffiato
blown glass

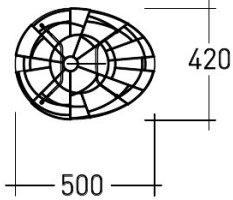
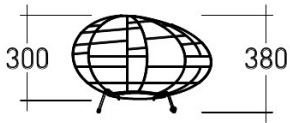

metallo nickelato nero
nickel black metal

bianco / white

EGGT 5 30262

1.490

CE

Attenzione!
Montare solo lampadine LED
max 21W E27 dimmerabili
Dimmer

Warning!
Only dimmable light LED bulb
max 21W E27
Dimmer

EGG SOSPENSIONE PENDANT

vetro soffiato
blown glass

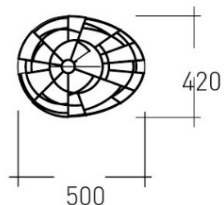
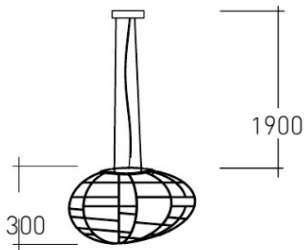

metallo nickelato nero
nickel black metal

bianco / white

EGGS 5 30232

1.490

CE

Lampadine consigliate:
1 LED max 21W E27
1 fluorescente 33W E27



Suggested light bulbs:
1 LED max 21W E27
1 fluorescent 33W E27

NB. DIFFUSORE IN VETRO SOFFIATO ARTIGIANALMENTE, LE LAMPADE POTRANNO PRESENTARE MINIME DIFFERENZE TRA LORO.
NB. HANDCRAFTED BLOWN GLASS, LAMPS CAN SLIGHTLY DIFFER ONE FROM ANOTHER.

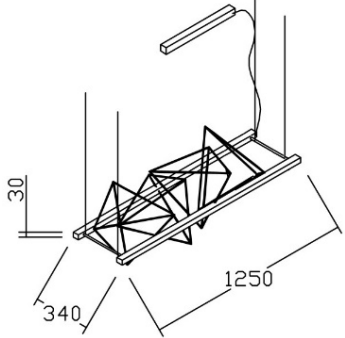
lampade / lamps

Nome Name	Struttura Frame	Diffusore Diffuser	Codice Code	EURO
ROCK GARDEN COMPOSIZIONE 1	metallo verniciato opaco matt lacquered metal	metacrilato opalino opal methacrylate	RCK 01W	1.380
			RCK 01B	1.380
	bianco opaco / matt white nero opaco / matt black	COMPOSIZIONE: 1 sospensione da 1250, 4 piramidi nb.: specificare il colore delle singole piramidi	COMPOSITION: 1 pendant frame 1250, 4 pyramids please note: specify the pyramids colors	
			Strip LED luce sopra e sotto 72W Flusso luminoso: 1960 lm/mt - 140 lm/W 2700K - Dimmerabile	
CE				

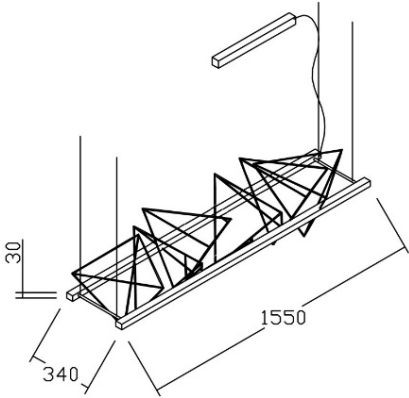
ROCK GARDEN COMPOSIZIONE 2

	metallo verniciato opaco matt lacquered metal	metacrilato opalino opal methacrylate	RCK 02W	1.544
			RCK 02B	1.544
	bianco opaco / matt white nero opaco / matt black	COMPOSIZIONE: 1 sospensione da 1550, 5 piramidi nb.: specificare il colore delle singole piramidi	COMPOSITION: 1 pendant frame 1550, 5 pyramids please note: specify the pyramids colors	
			Strip LED luce sopra e sotto 90W Flusso luminoso: 1960 lm/mt - 140 lm/W 2700K - Dimmerabile	

ROCK GARDEN PIRAMIDE PYRAMID

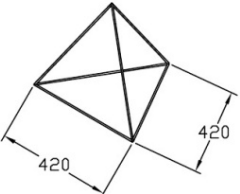
	metallo verniciato opaco matt lacquered metal	RCK 901 0 19764	85
		RCK 901 0 19765	85
		RCK 901 0 19766	85

lampade / lamps

Nome Name	Struttura Frame	Codice Code	EURO
--------------	--------------------	----------------	------

ROCK GARDEN SOSPENSIONE SPOT BIANCO PENDANT SPOT WHITE

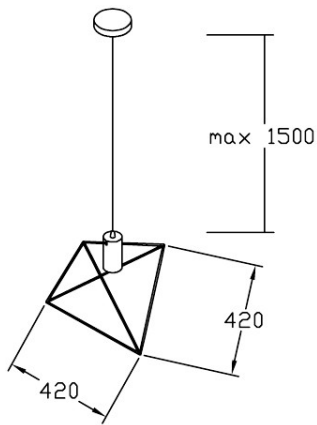

metallo verniciato opaco
matt lacquered metal
bianco opaco / matt white

piramide bianca / white pyramid	RCK 101 0 19758	315
piramide nera / black pyramid	RCK 101 0 19760	315
piramide rossa / red pyramid	RCK 101 0 19762	315



Lampadina consigliata:
1 lampadina LED PAR16
6,5W GU10 350lm

Suggested light bulb:
1 LED light bulb PAR16
6,5W GU10 350lm

ROCK GARDEN SOSPENSIONE SPOT NERO PENDANT SPOT BLACK

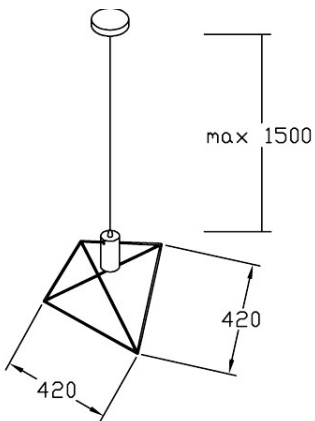

metallo verniciato opaco
matt lacquered metal
nero opaco / matt black

piramide bianca / white pyramid	RCK 101 0 19759	315
piramide nera / black pyramid	RCK 101 0 19761	315
piramide rossa / red pyramid	RCK 101 0 19763	315



Lampadina consigliata:
1 lampadina LED PAR16
6,5W GU10 350lm

Suggested light bulb:
1 LED light bulb PAR16
6,5W GU10 350lm

lampade / lamps

Nome Name	Struttura Frame	Diffusore Diffuser	Codice Code	EURO
--------------	--------------------	-----------------------	----------------	------

ALEXANDRA SOSPENSIONE 1 PENDANT 1

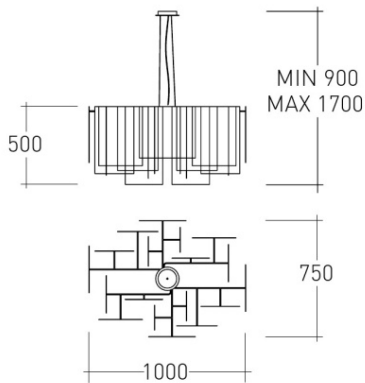

metallo grigio
lacquered metal grey

vetroresina / fiberglass

bianco / white

ALXS 1 30001

1.135

CE

Lampadine consigliate:
1 max 21W E27 LED
1 max 205W E27 alogena
IP20

Suggested light bulbs:
1 max 21W E27 LED
1 max 205W E27 halogene
IP20

ALEXANDRA SOSPENSIONE 3 PENDANT 3

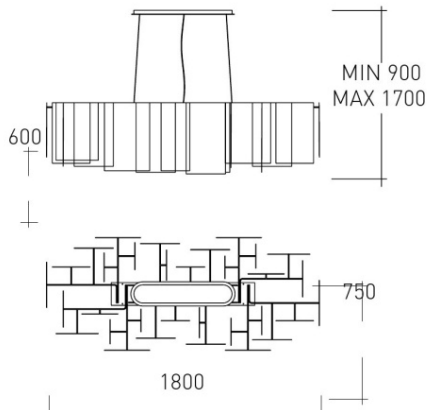

metallo grigio
lacquered metal grey

vetroresina / fiberglass

bianco / white

ALXS 3 30005

1.980

CE

Lampadine consigliate:
2 max 21W E27 LED
2 max 105W E27 alogena
IP20

Suggested light bulbs:
2 max 21W E27 LED
2 max 105W E27 halogene
IP20

lampade / lamps

Nome Name	Struttura Frame	Diffusore Diffuser	Codice Code	EURO
--------------	--------------------	-----------------------	----------------	------

ALEXANDRA LONG SOSPENSIONE 1 LONG PENDANT 1

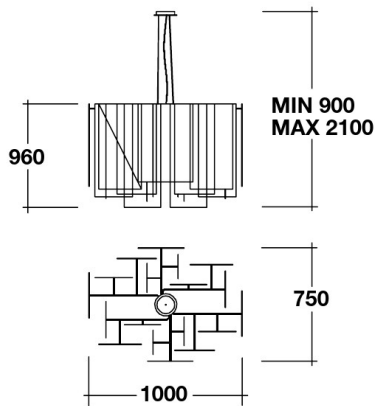

metallo grigio
lacquered metal grey

vetroresina / fiberglass

bianco / white

ALXL 1 30001

1.480



Lampadine consigliate:
1 max 21W E27 LED
1 max 205W E27 alogena
IP20

Suggested light bulbs:
1 max 21W E27 LED
1 max 205W E27 halogene
IP20

ALEXANDRA LONG SOSPENSIONE 3 LONG PENDANT 3

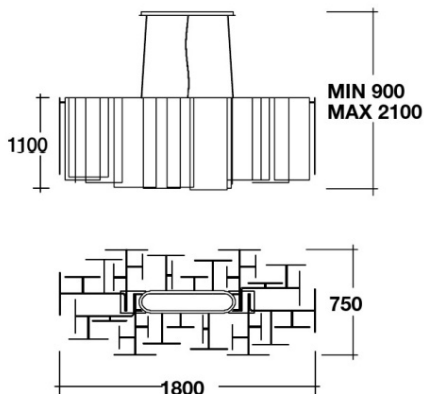

metallo grigio
lacquered metal grey

vetroresina / fiberglass

bianco / white

ALXL 3 30005

2.600



Lampadine consigliate:
2 max 21W E27 LED
2 max 105W E27 alogena
IP20

Suggested light bulbs:
2 max 21W E27 LED
2 max 105W E27 halogene
IP20

lampade / lamps

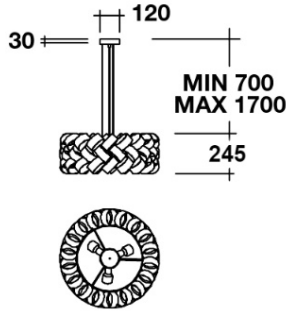
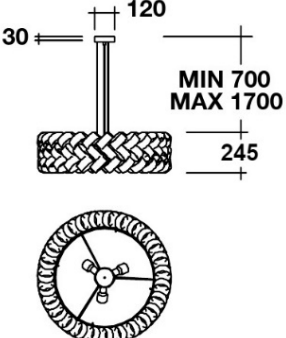
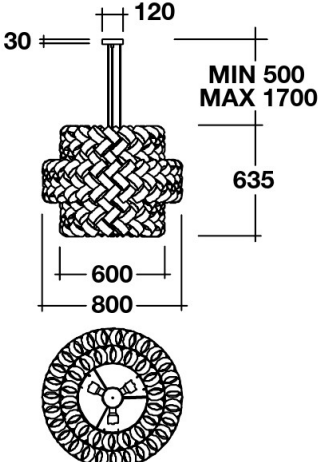
Nome Name	Struttura Frame	Diffusore Diffuser	Codice Code	EURO
RING SOSPENSIONE Ø 600 PENDANT Ø 600	acciaio verniciato bianco opaco matt white lacquered steel	PVC bianco white PVC	RNGS 1 20462	908
	acciaio verniciato bianco opaco matt white lacquered steel	PVC esterno bianco opaco interno oro PVC outside matt white inside gold	RNGS 1 20467	908
	acciaio verniciato nero opaco matt black lacquered steel	PVC esterno nero opaco interno oro PVC outside matt black inside gold	RNGS 1 20468	908
	Lampadine consigliate: 3 max 15W E27 LED 3 max 100W E 27 alogena IP20		Suggested light bulbs: 3 max 15W E27 LED 3 max 100W E 27 halogene IP20	
RING SOSPENSIONE Ø 800 PENDANT Ø 800	acciaio verniciato bianco opaco matt white lacquered steel	PVC bianco white PVC	RNGS 2 20462	1.176
	acciaio verniciato bianco opaco matt white lacquered steel	PVC esterno bianco opaco interno oro PVC outside matt white inside gold	RNGS 2 20467	1.176
	acciaio verniciato nero opaco matt black lacquered steel	PVC esterno nero opaco interno oro PVC outside matt black inside gold	RNGS 2 20468	1.176
	Lampadine consigliate: 3 max 15W E27 LED 3 max 100W E 27 alogena IP20		Suggested light bulbs: 3 max 15W E27 LED 3 max 100W E 27 halogene IP20	
RING SOSPENSIONE Ø 800 MIX PENDANT Ø 800 MIX	acciaio verniciato bianco Opaco matt white lacquered steel	PVC bianco white PVC	RNGM 1 20462	2.532
	acciaio verniciato bianco opaco matt white lacquered steel	PVC esterno bianco opaco interno oro PVC outside matt white inside gold	RNGM 1 20467	2.532
	acciaio verniciato nero opaco matt black lacquered steel	PVC esterno nero opaco interno oro PVC outside matt black inside gold	RNGM 1 20468	2.532
	Lampadine consigliate: 6 max 15W E27 LED IP20		Suggested light bulbs: 6 max 15W E27 LED IP20	

lampade / lamps

Nome Name	Struttura Frame	Diffusore Diffuser	Codice Code	EURO
--------------	--------------------	-----------------------	----------------	------

RING SPHERE Ø 500 SOSPENSIONE/PENDANT

acciaio verniciato
bianco opaco /
matt white lacquered
steel

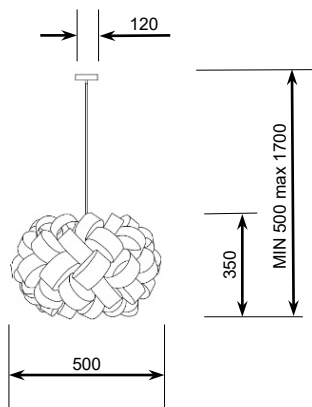

oro gold	RNGSS.GD.GD	908
rame copper	RNGSS.RA.RA	908
nichel nickel	RNGSS.NC.NC	908

CE

Lampadine consigliate:
1 LED 21W E27
1 alogena 100W E27
1 fluorescente 20W E27

Suggested light bulb:
1 LED 21W E27
1 halogene 100W E27
1 fluorescent 20W E27

lampade / lamps

Nome Name	Struttura Frame	Diffusore Diffuser	Codice Code	EURO
--------------	--------------------	-----------------------	----------------	------

GRID SOSPENSIONE PICCOLA Ø 300 SMALL PENDANT Ø 300

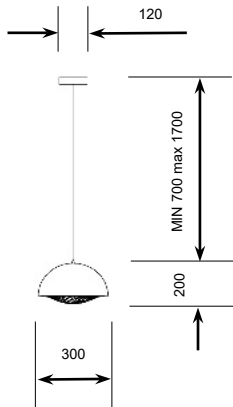

alluminio verniciato
bianco opaco
matt white lacquered
aluminium

bianco
white

GRDS 6 20472

575

alluminio verniciato
nero opaco
matt black lacquered
aluminium

bianco
white

GRDS 6 20474

595



Modulo LED 15W 3000K
2000lm

1 LED Module 15W 3000K
2000lm

GRID SOSPENSIONE Ø 600 PENDANT

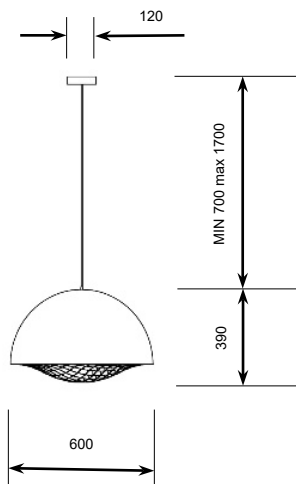

alluminio verniciato
bianco opaco
matt white lacquered
aluminium

forex bianco
white forex

GRDS 1 20472

790

alluminio verniciato
nero opaco
matt black lacquered
aluminium

forex bianco
white forex

GRDS 1 20474

790



Lampadine consigliate:
3 LED max 7W E27

Suggested light bulbs:
3 LED max 7W E27

lampade / lamps

Nome Name	Struttura Frame	Diffusore Diffuser	Codice Code	EURO
--------------	--------------------	-----------------------	----------------	------

GRID TERRA/TAVOLO Ø 300 FLOOR/TABLE Ø 300

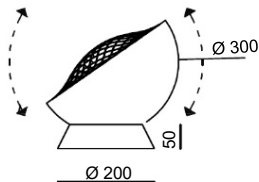

alluminio verniciato
bianco opaco
matt white lacquered
aluminium

bianco
white

GRDT30.WH

670

alluminio verniciato
nero opaco
matt black lacquered
aluminium

bianco
white

GRDT30.BK

690

CE

Modulo LED 15W 3000K
2000lm dimmerabile

1 LED Module 15W 3000K
2000lm dimmable

lampade / lamps

Nome Name	Finitura Finishing	Alimentatore Ballast	Temperatura Temperature	Codice Code	EURO
--------------	-----------------------	-------------------------	----------------------------	----------------	------

GRAFFITI SOSPENSIONE 1800 PENDANT 1800

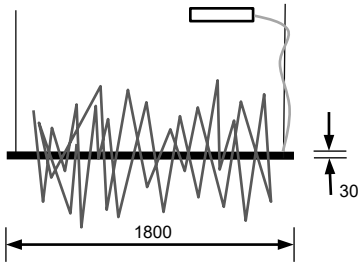

alluminio antracite satinato	Elettronico ON/OFF	2700 K°	GRF 618M 20628	1.225
satined aluminium anthracite	Electronic ON/OFF			

Versione per attacco a soffitto completa di 6 kit bacchette decorative e alimentatore on/off
Celing version with 6 decorative stick kits and on/off ballast

Su richiesta:

- Alimentatore Dali
- Taglio a misura con passo 5cm

On Request:

- Dali ballast
- Cut to size each 5cm

CE

Strip LED luce sopra e sotto
57W - light source 24V 52W
Flusso luminoso: 1960 lm/mt - 140 lm/W
IP20

Strip LED light up and down
57W - light source 24V 52W
Luminous flux: 1960 lm/mt - 140 lm/W
IP20

GRAFFITI 1 KIT BACCHETTE DECORATIVE 360-720-900-630mm 1 DECORATIVE STICK KIT 360-720-900-630mm

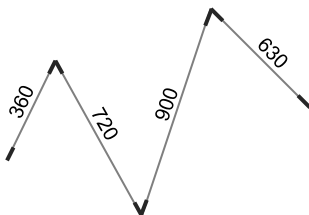

Acciaio INOX
INOX steel

GRF 711 20629

40

completo di guaina termo restringente
with heat shrink tubes

lampade / lamps

Nome Name	Finitura Finishing	Alimentatore Ballast	Temperatura Temperature	Codice Code	EURO
--------------	-----------------------	-------------------------	----------------------------	----------------	------

GRAFFITI SOSPENSIONE 2400 PENDANT 2400

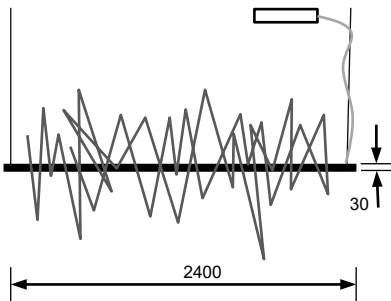

alluminio antracite satinato	Elettronico ON/OFF	2700 K°	GRF 624M 20628	1.525
satined aluminium anthracite	Electronic ON/OFF			

Versione per attacco a soffitto completa di 8 kit bacchette decorative e alimentatore on/off
Celing version with 8 decorative stick kits and on/off ballast

Su richiesta:

- Alimentatore Dali
- Taglio a misura con passo 5cm

On Request:

- Dali ballast
- Cut to size each 5cm

CE

Strip LED luce sopra e sotto
85W - light source 24V 76,8W
Flusso luminoso: 1960 lm/mt - 140 lm/W
IP20

Strip LED light up and down
85W - light source 24V 76,8W
Luminous flux: 1960 lm/mt - 140 lm/W
IP20

GRAFFITI 1 KIT BACCHETTE DECORATIVE 360-720-900-630mm 1 DECORATIVE STICK KIT 360-720-900-630mm

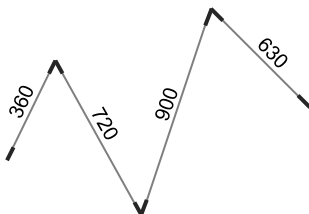

Acciaio INOX
INOX steel

GRF 711 20629 40

completo di guaina termo restringente
with heat shrink tubes

lampade / lamps

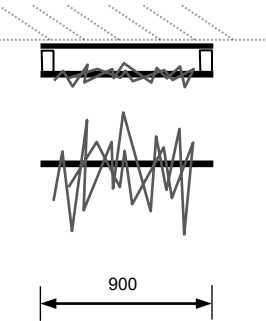
Nome Name	Finitura Finishing	Alimentatore Ballast	Temperatura Temperature	Codice Code	EURO
GRAFFITI APPLIQUE 900 WALL 900	alluminio antracite satinato satined aluminium anthracite	Elettronico remoto ON/OFF Remote electronic ON/OFF	2700 K°	GRF 209M 20628	915
	Completa di 4 kit bacchette decorative With 4 decorative stick kits				
CE	Alimentatore integrato on/off Strip LED luce sopra e sotto 30W - light source 24V 23,3W Flusso luminoso: 1960 lm/mt - 140 lm/W IP20		Integrated on/off ballast Strip LED light up and down 30W - light source 24V 23,3W Luminous flux: 1960 lm/mt - 140 lm/W IP20		

GRAFFITI APPLIQUE 1200 WALL 1200

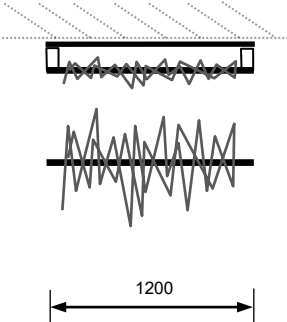
	alluminio antracite satinato satined aluminium anthracite	Elettronico remoto ON/OFF Remote electronic ON/OFF	2700 K°	GRF 212M 20628	1.020
	Completa di 6 kit bacchette decorative With 6 decorative stick kits				
CE	Alimentatore integrato on/off Strip LED luce sopra e sotto 44W - light source 24V 31,2W Flusso luminoso: 1960 lm/mt - 140 lm/W IP20		Integrated on/off ballast Strip LED light up and down 44W - light source 24V 31,2W Luminous flux: 1960 lm/mt - 140 lm/W IP20		

GRAFFITI 1 KIT BACCHETTE DECORATIVE 180-360-450-315mm 1 DECORATIVE STICK KIT 180-360-450-315mm



Acciaio INOX INOX steel	GRF 721 20629	40
completo di guaina termo restringente with heat shrink tubes		

lampade / lamps

Nome Name	Struttura Frame	Diffusore Diffuser	Codice Code	EURO
RAINY DAY BASE/PARETE BASE/WALL				
		Polietilene stampato in rotazione Rotomolded polyethylene		
	Supporto per aggancio a parete in acciaio verniciato argento	bianco traslucido white	RAN 001 15053	265
	The wall support Racket is in silver lacquer steel	verde acido traslucido acid Green	RAN 001 15057	265
Inserita nella collezione permanente MoMA di NEW YORK Included in MoMA 's collection (NEW YORK)				
CE	8 metri di cavo con interruttore on/off Strip LED 15W 3000K		Cable 8 meters with on/off switch Strip LED 15W 3000K	

lampade / lamps

Nome Name	Struttura Frame	Diffusore Diffuser	Codice Code	EURO
--------------	--------------------	-----------------------	----------------	------

CALLA PICCOLA SMALL



acciaio nero
black steel

fibra di vetro bianco
fiber glass white

CAL217.BK.WH

1.340

acciaio oro
brushed
gold steel

fibra di vetro bianco
fiber glass white

CAL217.GD.WH

1.640

CE

Modulo LED 15W 3000K
2000lm dimmerabile

1 LED Module 15W 3000K
2000lm dimmable

CALLA GRANDE BIG

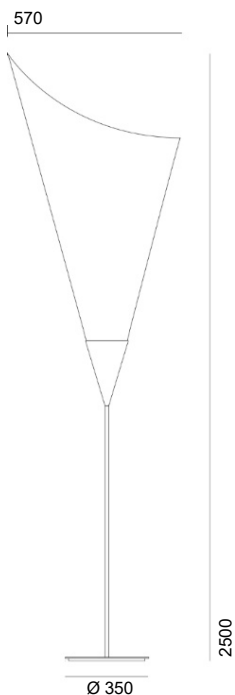

acciaio nero
black steel

fibra di vetro bianco
fiber glass white

CAL250.BK.WH

1.540

acciaio oro
brushed
gold steel

fibra di vetro bianco
fiber glass white

CAL250.GD.WH

1.840

CE

Modulo LED 15W 3000K
2000lm dimmerabile

1 LED Module 15W 3000K
2000lm dimmable

MICRO TELESCOPIC DIMENSION

SOSPENSIONE A 3 ELEMENTI
PENDANT 3 ELEMENTS

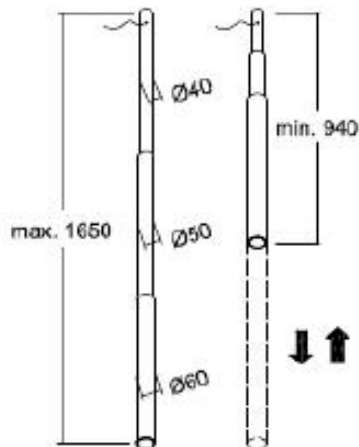

SOSPENSIONE A 4 ELEMENTI
PENDANT 4 ELEMENTS

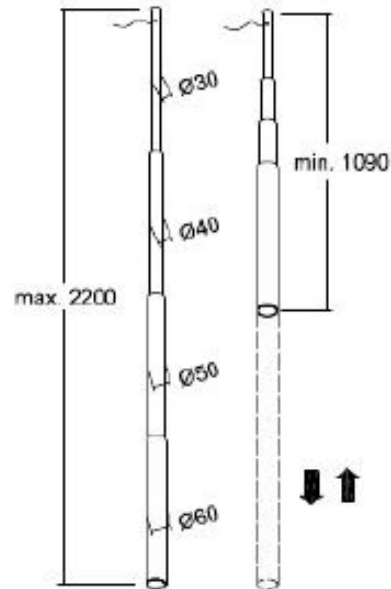

MICRO TELESCOPIC MECHANISM

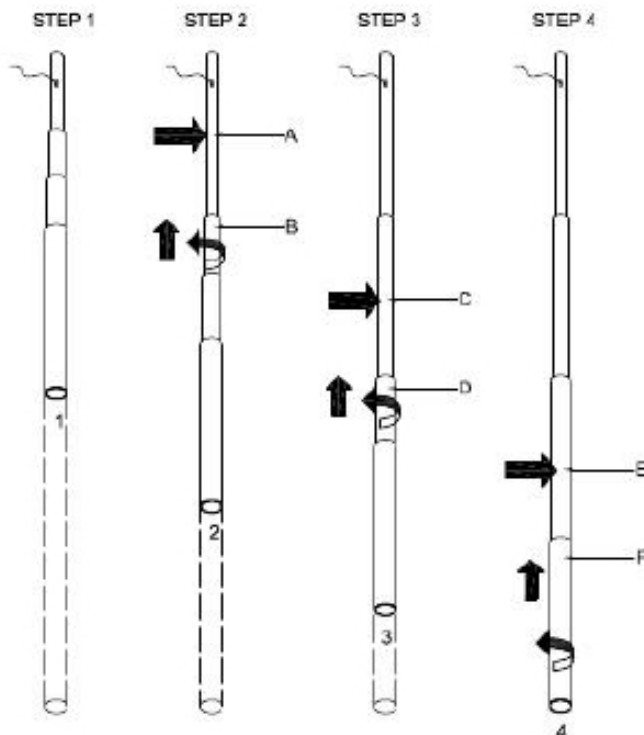

PER ABBASSARE LA LAMPADA ESEGUIRE I SEGUENTI MOVIMENTI:

STEP 1 - TENERE FERMO IL SETTORE -A-, GIRARE IN SENSO ANTIORARIO PER 1/2 GIRO IL SETTORE B, PER BLOCCARE GIRARE IN SENSO ORARIO IL SETTORE -B-.
STEP 2-3-4 RIPETERE LA PROCEDURA DESCRITTA NELLA FASE 1 PER ABBASSARE AMICHE GLI ALTRI ELEMENTI.

PER ALLUNGARE LA LAMPADA PROCEDERE IN SEQUENZA INVERSA E CON LO STESSO CRITERIO.

NON BLOCCARE CON TROPPIA FORZA I VARI SETTORI.

NON GIRARE ULTERIORMENTE IN SENSO ANTIORARIO.

IL BLOCCAGGIO SI OTTIENE GIRANDO IL SETTORE IN SENSO ORARIO, QUANDO NELLA FASE DI ROTAZIONE SI SENTE CHE IL TUBO NON GIRA PIU', IL BLOCCAGGIO E' COMPLETO.

IN ORDER TO REDUCE THE LENGTH OF THE LAMP, PLEASE FOLLOW BELOW INSTRUCTIONS.

1a- HOLD SECTION -A-, **1b** - MAKE A HALF TURN ANTICLOCKWISE ON SECTION -B-, **1c**- LOWER THE SECTION TO THE DESIRED POSITION. **1d**- BLOCK THE SECTION -B- BY TURNING IT CLOCKWISE. **2-3-4** REPEAT THE ABOVE MENTIONED OPERATIONS TO REGULATE THE OTHER SECTIONS.

IN ORDER TO EXTENDED THE LAMP, REPEAT THESE STEPS STARTING FROM POINT 1d- AND GOING TO POINT 1a.

DO NOT FASTEN THE SECTIONS TOO TIGHT.

DO NOT TURN ANTICLOCKWISE ANY FURTHER.



THE SECTION IS BLOCCED BY TURNING IT CLOCKWISE. WHEN THE TUBE DOES NOT TURN ANYMORE. THIS MEANS THE SEVTION IS CORRECTLY BLOCCED.

MICRO TELESCOPIC

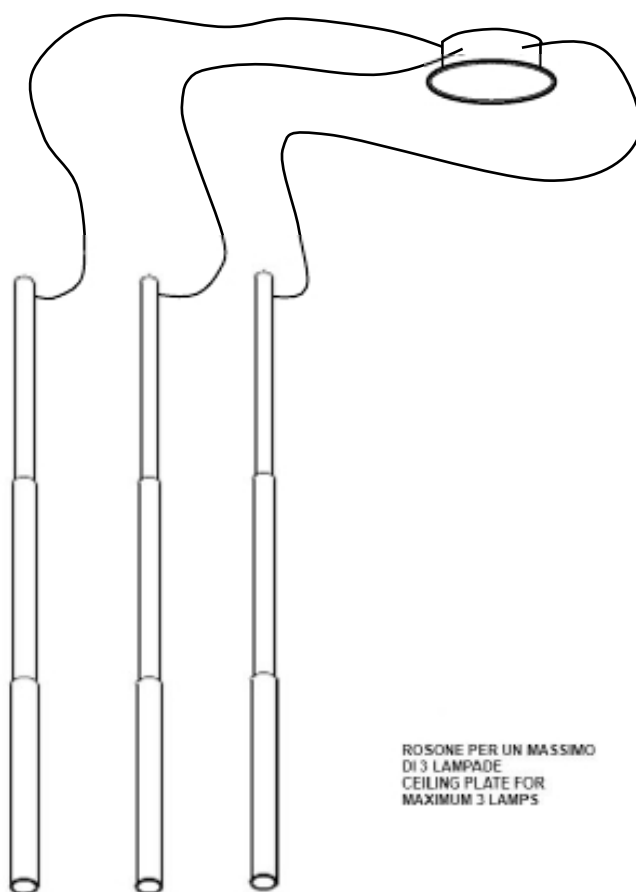
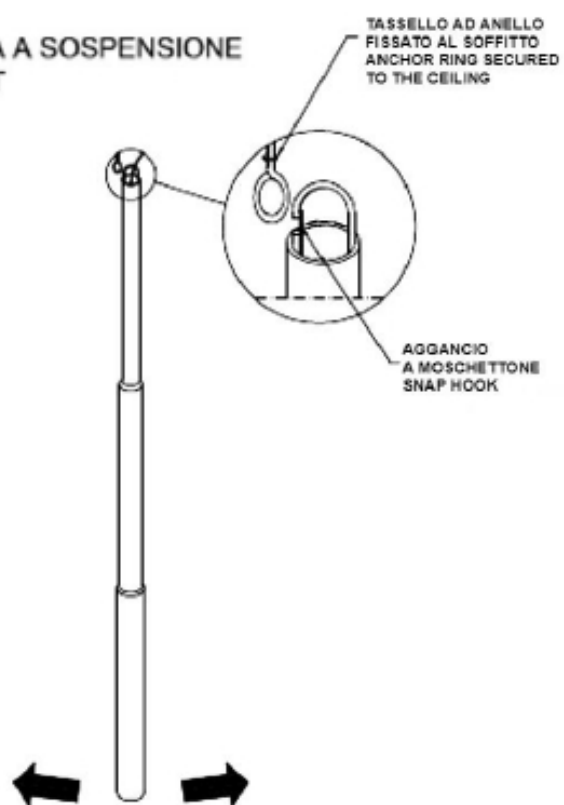
LAMPADA A SOSPENSIONE
PENDANT

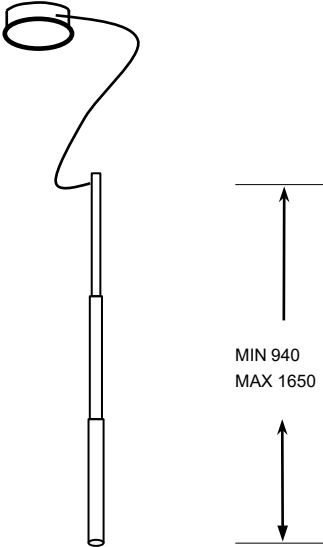

lampade / lamps

Nome Name	Diffusore Lampshade	Codice Code	EURO
MICRO TELESCOPIC COMPOSIZIONE 1.3 COMPOSITION 1.3			
	Alluminio verniciato Lacquered aluminium		
	bianco opaco matt white	MTS.C3.WH	710
	nero opaco matt black	MTS.C3.BK	710
	nichel nickel	MTS.C3.NK	880
	COMPOSIZIONE: 1 lampada a 3 elementi 1 rosone per 1 lampada	COMPOSITION: 1 lamp with 3 elements 1 ceiling plate for 1 lamp	
	Lampadina consigliata: 1 LED max 9W GU10	Suggested light bulb: 1 LED max 9W GU10	

MICRO TELESCOPIC COMPOSIZIONE 1.4 COMPOSITION 1.4

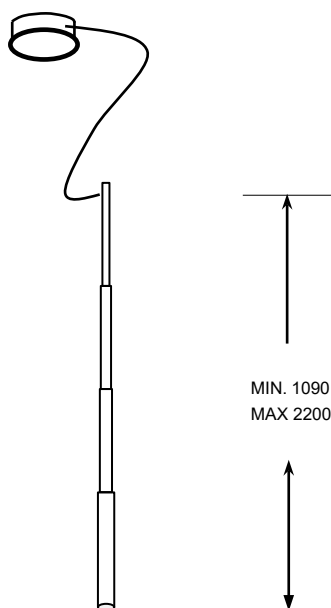

Alluminio verniciato
Lacquered aluminium

bianco opaco
matt white

MTS.C4.WH

775

nero opaco
matt black

MTS.C4.BK

775

nichel
nickel

MTS.C4.NK

970

COMPOSIZIONE:
1 lampada a 4 elementi
1 rosone per 1 lampada

COMPOSITION:
1 lamp with 4 elements
1 ceiling plate for 1 lamp



Lampadina consigliata:
1 LED max 9W GU10

Suggested light bulb:
1 LED max 9W GU10

lampade / lamps

Nome Name	Diffusore Lampshade	Codice Code	EURO
MICRO TELESCOPIC COMPOSIZIONE 2.3 COMPOSITION 2.3			
	Alluminio verniciato Lacquered aluminium		
	bianco opaco matt white	MTS.C33.WH	1.370
	nero opaco matt black	MTS.C33.BK	1.370
	nicel nickel	MTS.C33.NK	1.705
	COMPOSIZIONE: 2 lampade a 3 elementi 1 rosone per 2 lampade	COMPOSITION: 2 lamps with 3 elements 1 ceiling plate for 2 lamps	



Lampadine consigliate:
2 LED max 9W GU10

Suggested light bulbs:
2 LED max 9W GU10

MICRO TELESCOPIC

COMPOSIZIONE 2.4

COMPOSITION 2.4



	Alluminio verniciato Lacquered aluminium		
	bianco opaco matt white	MTS.C44.WH	1.495
	nero opaco matt black	MTS.C44.BK	1.495
	nicel nickel	MTS.C44.NK	1.885
	COMPOSIZIONE: 2 lampade a 4 elementi 1 rosone per 2 lampade	COMPOSITION: 2 lamps with 4 elements 1 ceiling plate for 2 lamps	



Lampadine consigliate:
2 LED max 9W GU10

Suggested light bulbs:
2 LED max 9W GU10

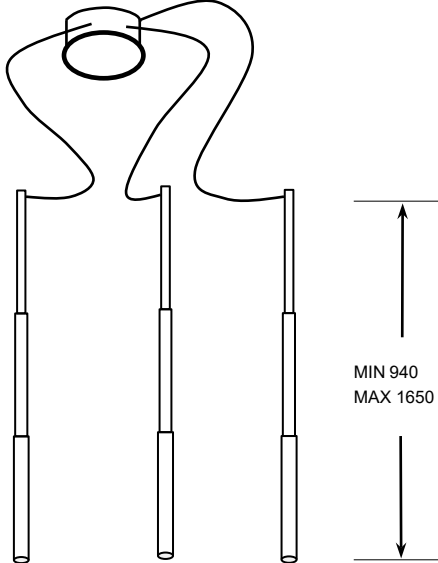
lampade / lamps

Nome Name	Diffusore Lampshade	Codice Code	EURO
MICRO TELESCOPIC COMPOSIZIONE 3.3 COMPOSITION 3.3			
	Alluminio verniciato Lacquered aluminium		
	bianco opaco matt white	MTS.C333.WH	2.030
	nero opaco matt black	MTS.C333.BK	2.030
	nichel nickel	MTS.C333.NK	2.530
	COMPOSIZIONE: 3 lampade a 3 elementi 1 rosone per 3 lampade	COMPOSITION: 3 lamps with 3 elements 1 ceiling plate for 3 lamps	
	Lampadine consigliate: 3 LED max 9W GU10	Suggested light bulbs: 3 LED max 9W GU10	

MICRO TELESCOPIC

COMPOSIZIONE 3.4

COMPOSITION 3.4

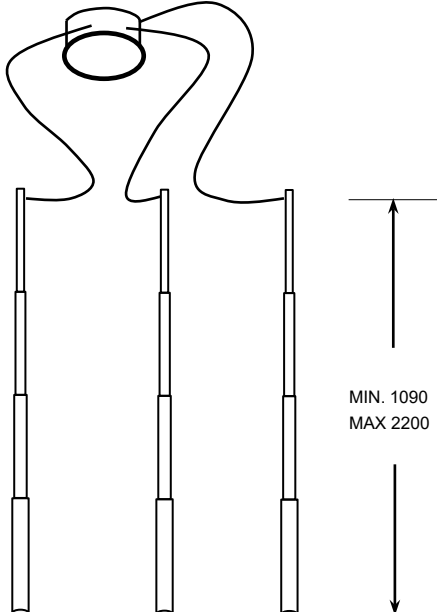
	Alluminio verniciato Lacquered aluminium		
	bianco opaco matt white	MTS.C444.WH	2.220
	nero opaco matt black	MTS.C444.BK	2.220
	nichel nickel	MTS.C444.NK	2.780
	COMPOSIZIONE: 3 lampade a 4 elementi 1 rosone per 3 lampade	COMPOSITION: 3 lamps with 4 elements 1 ceiling plate for 3 lamps	

CE

Lampadine consigliate:
3 LED max 9W GU10

Suggested light bulbs:
3 LED max 9W GU10

lampade / lamps

Nome Name	Diffusore Lampshade	Codice Code	EURO
--------------	------------------------	----------------	------

MICRO TELESCOPIC TERRA FLOOR

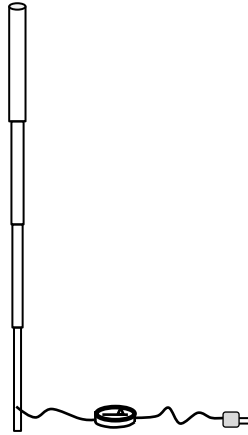
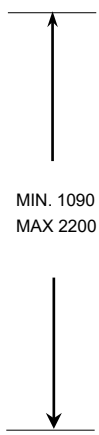

Alluminio verniciato
Lacquered aluminium

bianco opaco
matt white

MTS.T4.WH

1000

nero opaco
matt black

MTS.T4.BK

1000

nichel
nickel

MTS.T4.NK

1200



Lampadina consigliata:
1 LED max 9W GU10 dimmerabile

Suggested light bulb:
1 LED max 9W GU10 dimmable

MICRO TELESCOPIC BASE

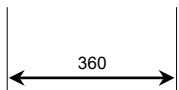
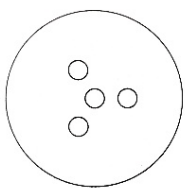
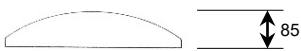





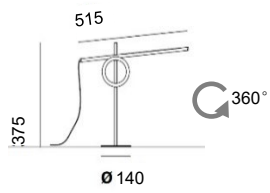

base in ghisa
cast iron base

MTS.B4.100

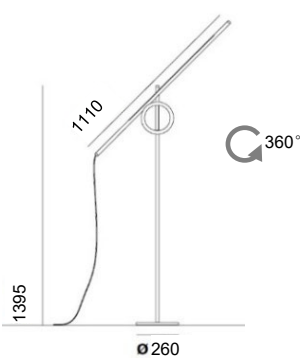
205

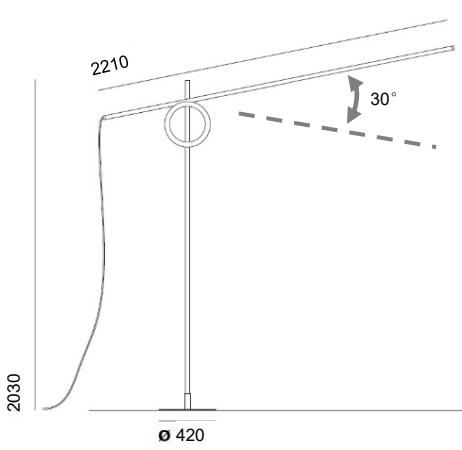
lampade / lamps

Nome Name	Struttura Frame	Diffusore Diffuser	Codice Code	EURO
TANGENT MINI				
	nero/black	nero/black	TNG038.BK	620
	bianco/white	bianco/white	TNG038.WH	620
 <p>H MAX: 650</p>				
	Strip LED 4,8W – light source 24V 2,5W Flusso luminoso: 1080 lm/mt IP20 dimmerabile		Strip LED 4,8W – light source 24V 2,5W Luminous flux: 1080 lm/mt IP20 dimmable	
TANGENT MEDIA				
	nero/black	nero/black	TNG141.BK	980
	bianco/white	bianco/white	TNG141.WH	980
 <p>H MAX: 2020</p>				
	Strip LED 14W – light source 24V 11W Flusso luminoso: 2150 lm/mt IP20 dimmerabile		Strip LED 14W – light source 24V 11W Luminous flux: 2150 lm/mt IP20 dimmable	
TANGENT XL				
	nero/black	nero/black	TNG203.BK	2.020
	bianco/white	bianco/white	TNG203.WH	2.020
				
	Strip LED 23W – light source 24V 19W Flusso luminoso: 2150 lm/mt IP20 dimmerabile		Strip LED 23W – light source 24V 19W Luminous flux: 2150 lm/mt IP20 dimmable	

lampade / lamps

Nome Name	Struttura Frame	Diffusore Diffuser	Codice Code	EURO
--------------	--------------------	-----------------------	----------------	------

TOTEM 60

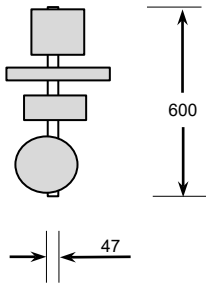

nero
black

**Combinato con/
Combined with:**

- purple red / rosso porpora
- blue green / ottanio
- black / nero
- gold / oro

TTM06.CA

600

* Lampada disponibile anche nella versione interamente bianca o bianca con un cerchio oro. Struttura nera.

* Available also in total white or white with one gold circle. Black frame.

CE

Strip LED
23W – light source 24V 18W
Flusso luminoso: 1960 lm/mt - 140 lm/W
IP20

Strip LED
23W – light source 24V 18W
Luminous flux: 1960 lm/mt - 140 lm/W
IP20

TOTEM 90

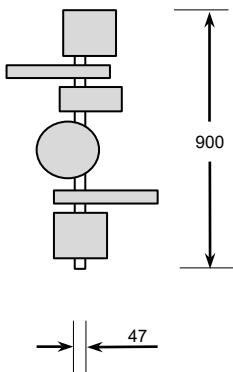

nero
black

**Combinato con/
Combined with:**

- purple red / rosso porpora
- rosa / pink
- blue green / ottanio
- black / nero
- gold / oro
- aquemarine / acquamarina

TTM09.CA

760

* Lampada disponibile anche nella versione interamente bianca o bianca con un cerchio oro. Struttura nera.

* Available also in total white or white with one gold circle. Black frame.

CE

Strip LED
33W – light source 24V 31,4W
Flusso luminoso: 1960 lm/mt - 140 lm/W
IP20

Strip LED
33W – light source 24V 31,4W
Luminous flux: 1960 lm/mt - 140 lm/W
IP20

lampade / lamps

Nome Name	Struttura Frame	Diffusore Diffuser	Codice Code	EURO
--------------	--------------------	-----------------------	----------------	------

TOTEM 120

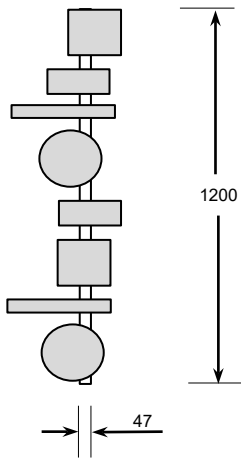

nero
black

Combinato con/ Combined with:

- purple red / rosso porpora
- rosa / pink
- blue green / ottanio
- black / nero
- gold / oro
- aquemarine / acquamarina
- purple red / rosso porpora
- blue green / ottanio

TTM12.CA

960

* Lampada disponibile anche nella versione interamente bianca o bianca con un cerchio oro. Struttura nera.

* Available also in total white or white with one gold circle. Black frame.

CE

Strip LED
45W – light source 24V 34W
Flusso luminoso: 1960 lm/mt - 140 lm/W
IP20

Strip LED
45W – light source 24V 34W
Luminous flux: 1960 lm/mt - 140 lm/W
IP20

TOTEM 200

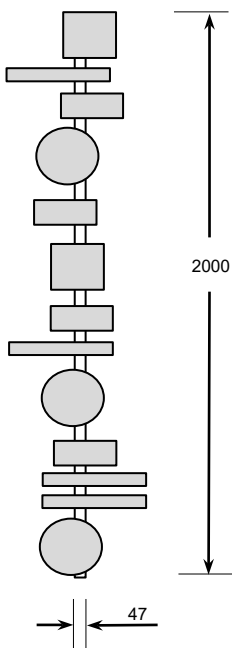

nero
black

Combinato con/ Combined with:

- purple red / rosso porpora
- rosa / pink
- blue green / ottanio
- black / nero
- gold / oro
- aquemarine / acquamarina
- purple red / rosso porpora
- blue green / ottanio
- aquemarine / acquamarina
- rosa / pink
- blue green / ottanio
- purple red / rosso porpora
- gold / oro

TTM20.CA

1.440

* Lampada disponibile anche nella versione interamente bianca o bianca con un cerchio oro. Struttura nera.

* Available also in total white or white with one gold circle. Black frame.

CE

Strip LED
58W – light source 24V 53,8W
Flusso luminoso: 1960 lm/mt - 140 lm/W
IP20

Strip LED
58W – light source 24V 53,8W
Luminous flux: 1960 lm/mt - 140 lm/W
IP20

lampade / lamps

Nome Name	Struttura Frame	Codice Code	EURO
--------------	--------------------	----------------	------

PERSONALIZZA LA TUA LAMPADA / CUSTOMIZE YOUR LAMP

TOTEM STRUTTURA DA 60

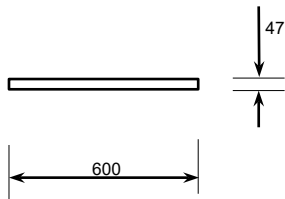

nero
black

TTMS.06.BK

471

CE

Strip LED
23W – light source 24V 18W
Flusso luminoso: 1960 lm/mt - 140 lm/W
IP20

Strip LED
23W – light source 24V 18W
Luminous flux: 1960 lm/mt - 140 lm/W
IP20

TOTEM STRUTTURA DA 90

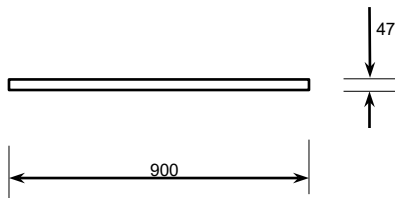

nero
black

TTMS.09.BK

576

CE

Strip LED
33W – light source 24V 31,4W
Flusso luminoso: 1960 lm/mt - 140 lm/W
IP20

Strip LED
33W – light source 24V 31,4W
Luminous flux: 1960 lm/mt - 140 lm/W
IP20

TOTEM STRUTTURA DA 120

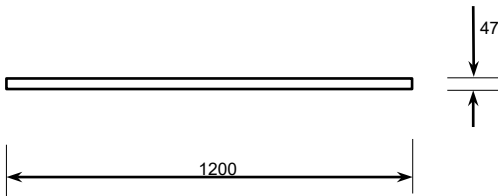

nero
black

TTMS.12.BK

719

CE

Strip LED
45W – light source 24V 34W
Flusso luminoso: 1960 lm/mt - 140 lm/W
IP20

Strip LED
45W – light source 24V 34W
Luminous flux: 1960 lm/mt - 140 lm/W
IP20

TOTEM STRUTTURA DA 200

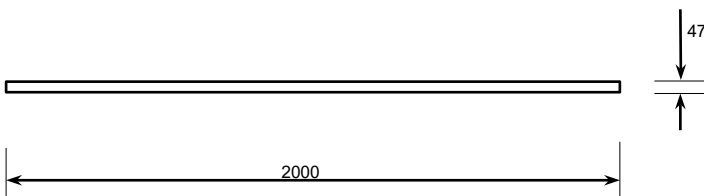

nero
black

TTMS.20.BK

1.031

CE

Strip LED
58W – light source 24V 53,8W
Flusso luminoso: 1960 lm/mt - 140 lm/W
IP20

Strip LED
58W – light source 24V 53,8W
Luminous flux: 1960 lm/mt - 140 lm/W
IP20

lampade / lamps

Nome Name	Struttura Frame	Codice Code	EURO
--------------	--------------------	----------------	------

TOTEM COMPONENTE QUADRATO SQUARE COMPONENT

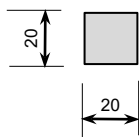

rosa / pink	TTMP.QPK	30
porpora / purple	TTMP.QPU	30

TOTEM COMPONENTE RETTANGOLARE RECTANGULAR COMPONENT

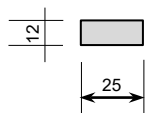

aquamarina / acquamarine	TTMP.RAM	30
ottanio / blue green	TTMP.RBG	30
rosa / pink	TTMP.RPK	30
porpora / purple	TTMP.RPU	30

TOTEM COMPONENTE LINEARE LINEAR COMPONENT

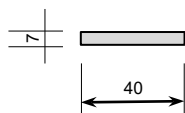

nero / black	TTMP.LBK	17
ottanio / blue green	TTMP.LBG	28
oro / gold	TTMP.LGD	50
porpora / purple	TTMP.LPU	28

TOTEM COMPONENTE CIRCOLARE CIRCULAR COMPONENT

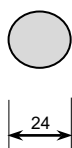

aquamarina / acquamarine	TTMP.CAM	27
ottanio / blue green	TTMP.CBG	27
oro / gold	TTMP.CGD	52

lampade / lamps

Nome Name	Diffusore Diffuser	Codice Code	EURO
--------------	-----------------------	----------------	------

TUBE 2.0

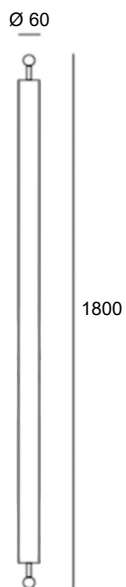

metacrilato
metacrylic

TUBT18.WH

825



Strip LED
27,5W – light source 24V 22W
Flusso luminoso: 730 lm/mt - 140 lm/W
IP20 dimmerabile

Strip LED
27,5W – light source 24V 22W
Luminous flux: 730 lm/mt - 140 lm/W
IP20 dimmable

indice
index

contenitori
container cabinets

Next Basic

pag. 47

librerie
bookcases

Continua

pag. 48

contenitori / containers

Nome Name	Codice Code	EURO
--------------	----------------	------

NEXT BASIC

Mobile contenitore, con struttura laccata opaca, nei colori bianco e grigio. Ante rivestite esternamente in lamiera di acciaio inox satinato. Schiena e interno delle ante nello stesso colore dell'esterno. 3 piedini in alluminio. Ogni mobile è completo di una maniglia in alluminio dotata di magnete. Ripiani interni (optional) in vetro trasparente temperato.

Storage unit with lacquered structure in the matt colors white and grey. Doors are externally finished in satined stainless steel. Back panel and internal of the doors are lacquered in the same colors as the external structure. Each container is equipped with 3 aluminium feet and a magnetic knob. Internal shelves (optional) are in tempered transparent glass.

NEXT BASIC A TRE ANTE THREE DOORS

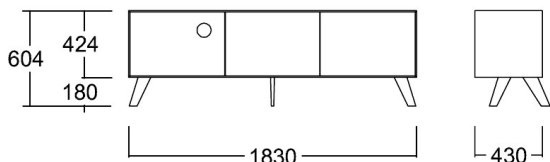

* BA2003W	laccato bianco opaco matt lacquered white	3.670
* BA2003G	laccato grigio opaco matt lacquered grey	3.670

NEXT BASIC A QUATTRO ANTE FOUR DOORS

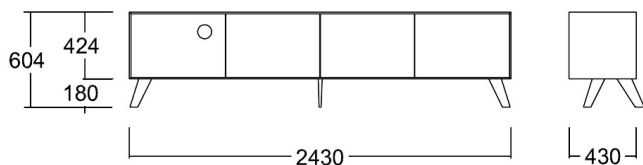

* BA2004W	laccato bianco opaco matt lacquered white	4.680
* BA2004G	laccato grigio opaco matt lacquered grey	4.680

NEXT BASIC RIPIANO INTERNO INTERNAL SHELF

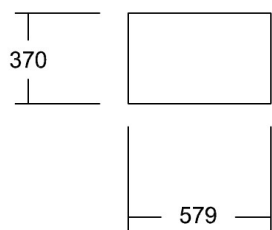

* RIBA2001	vetro trasparente temperato tempered clear glass	55
------------	---	----

NEXT BASIC MANIGLIA CON MAGNETE MAGNETIC KNOB

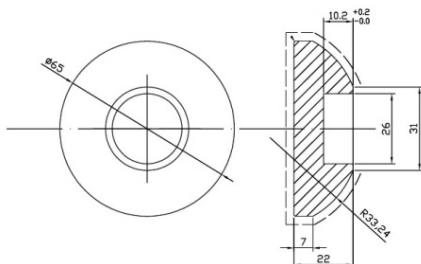

* MABA2001	maniglia in alluminio dotata di magnete magnetic knob	100
------------	--	-----

librerie / bookcases

Assonometria Versione Piani Alluminio / Axonometric view of the version with aluminium shelves

CONTINUA

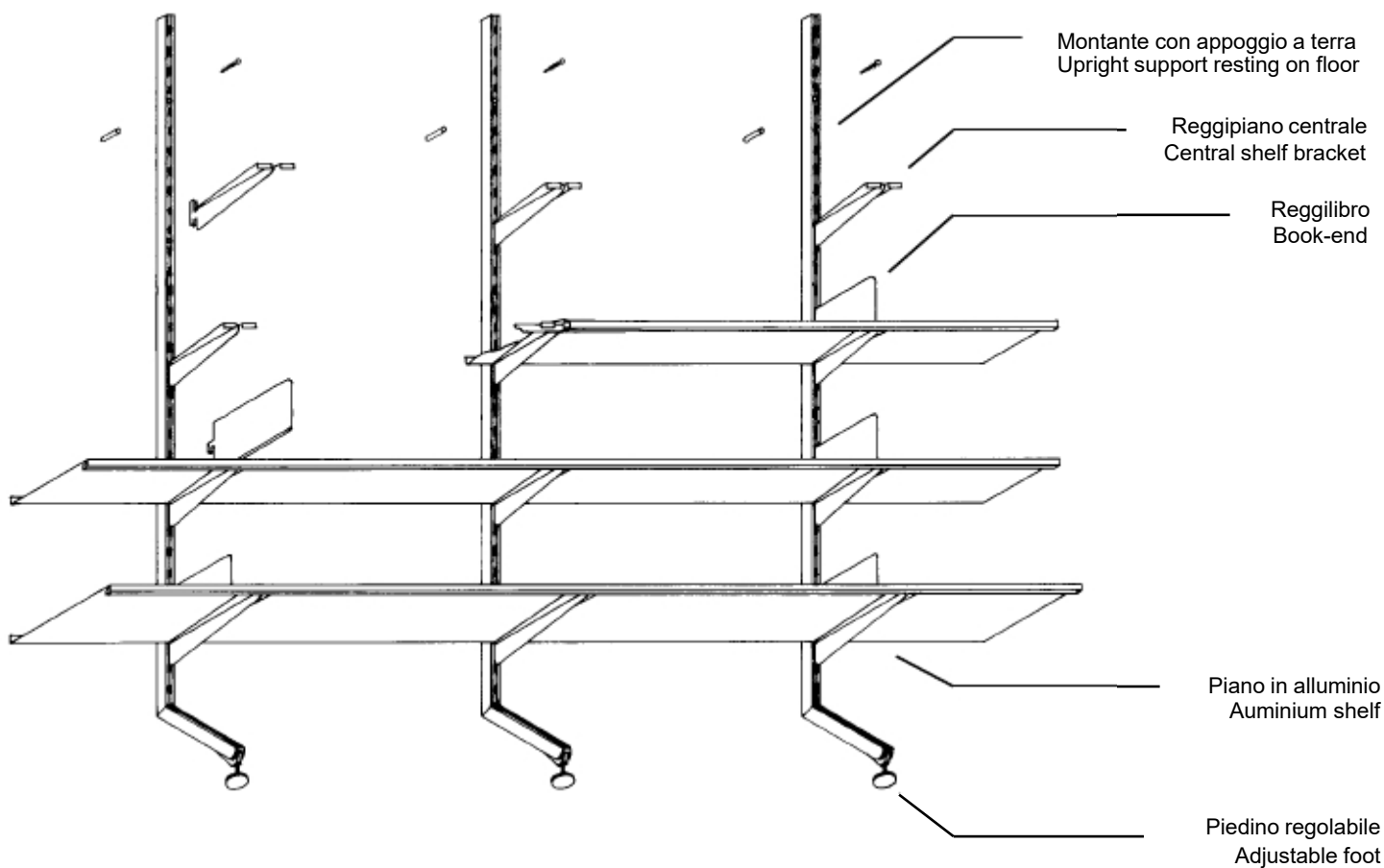

La libreria "CONTINUA" ha la struttura composta da: montanti, reggipiani, reggilibri e piani in alluminio sempre verniciati opaco nei colori argento, bianco e nero.

È consigliabile, per evitare errori, unire all'ordine anche grafico della composizione con l'elenco dei singoli componenti.

Il montante consente il posizionamento dei piani ogni 55 mm.

L'interasse massimo tra i montanti non deve superare i 900 mm.

Per le composizioni a sbalzo è consigliabile non superare un interasse di 300 mm.

Portata consigliata per piani alluminio prof. 260/360/460 con interasse 900 mm.: Kg. 40.

Portata consigliata per piani alluminio prof. 260/360/460 con interasse 750 mm.: Kg. 60.

librerie / bookcases

Assonometria Versione Piani Alluminio / Axonometric view of the version with aluminium shelves

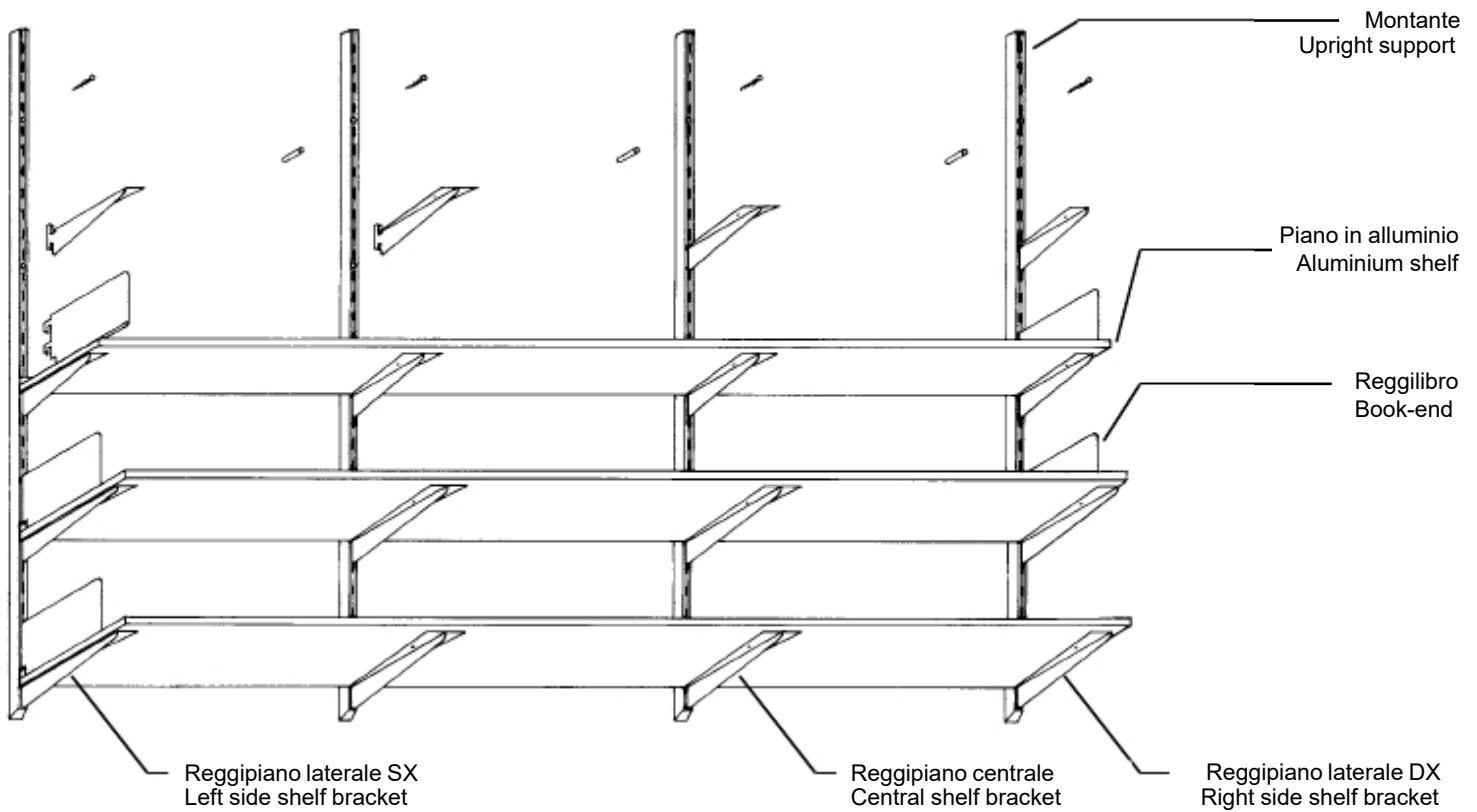

The "CONTINUA" bookcase has a structure composed of wall upright supports, shelf brackets, book-ends and aluminium shelf profiles, all matt lacquered in silver, white and black.

To avoid mistakes, it is advisable to enclose with your order a sketch of the composition and a list of the individual components.

The wall upright support allows the shelves to be positioned every 55 mm.

The maximum centre distance between uprights must not exceed 900 mm.

For end compositions, where shelves over-hang from wall upright, the recommended distance is 300 mm.

Maximum recommended carrying weight for aluminium shelves, depth 260/360/460, with centre distance of 900 mm. between wall upright supports: Kg. 40

Maximum recommended carrying weight for aluminium shelves, depth 260/360/460, with centre distance of 750 mm. between wall upright supports: Kg. 60

CONTINUA CENTRE

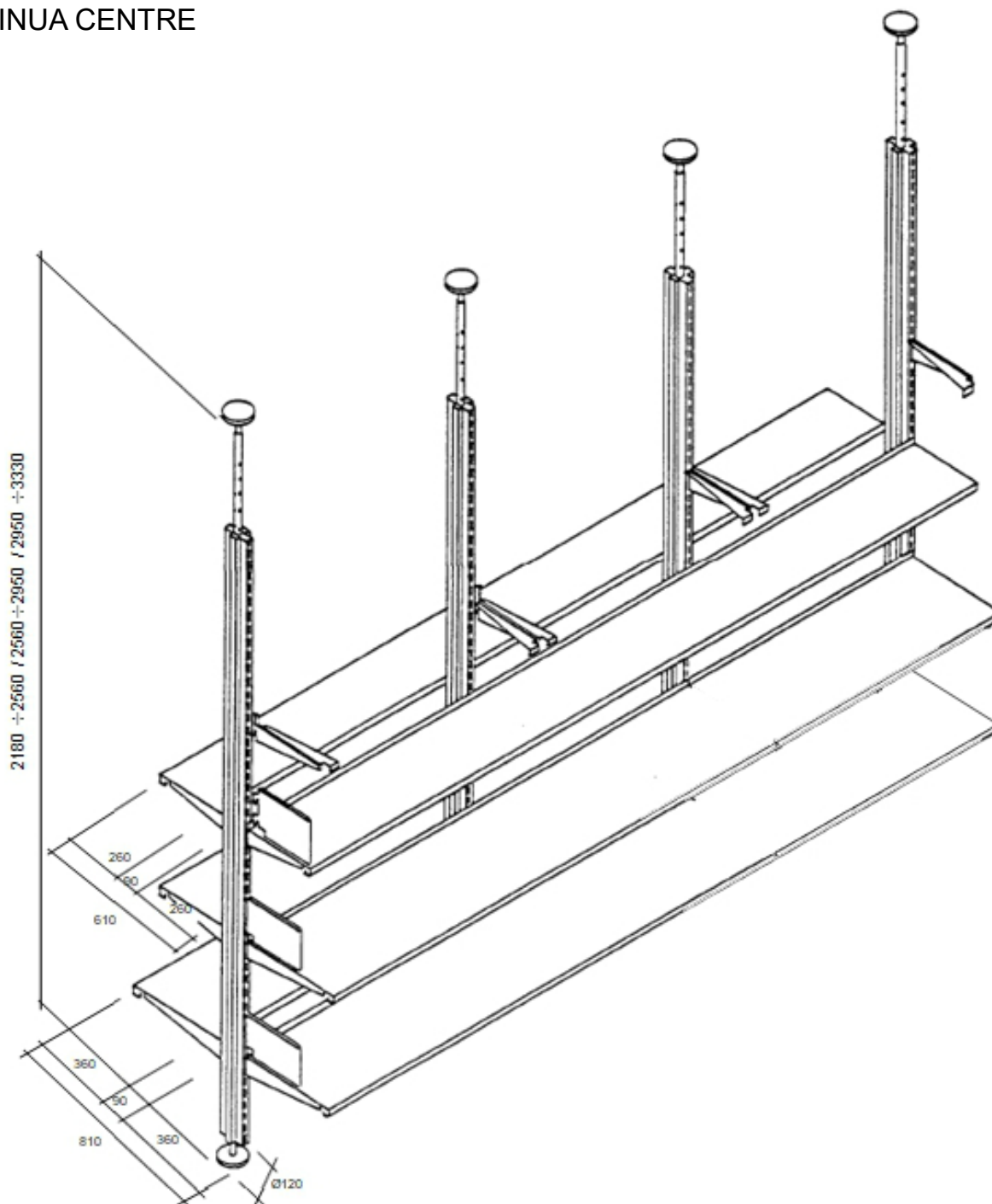

La libreria "CONTINUA centre" ha la struttura composta da montanti centrali con fissaggio a soffitto per mezzo di spintore regolabile telescopico con un'escursione massima di 385 mm, verniciati a polveri epossidiche nei colori argento, bianco e nero.

Piede e spintore, diametro 120 mm, sono sempre nella finitura argento.

I piani, i reggipiani e i reggilibri sono gli stessi che si utilizzano per la libreria Continua a muro.

Il montante Centre permette la composizione di librerie mono e bifacciali.

L'interasse massimo tra i montanti non deve superare i 900 mm.

Per le composizioni a sbalzo è consigliabile non superare lo sbalzo di 300 mm.

Portata consigliata per piani alluminio prof. 260/360/460 con interasse 900 mm.: Kg. 40.

Portata consigliata per piani alluminio prof. 260/360/460 con interasse 750 mm.: Kg. 60.

È necessario, dopo avere caricato la libreria, controllare il serraggio degli spintori del montante

CONTINUA CENTRE

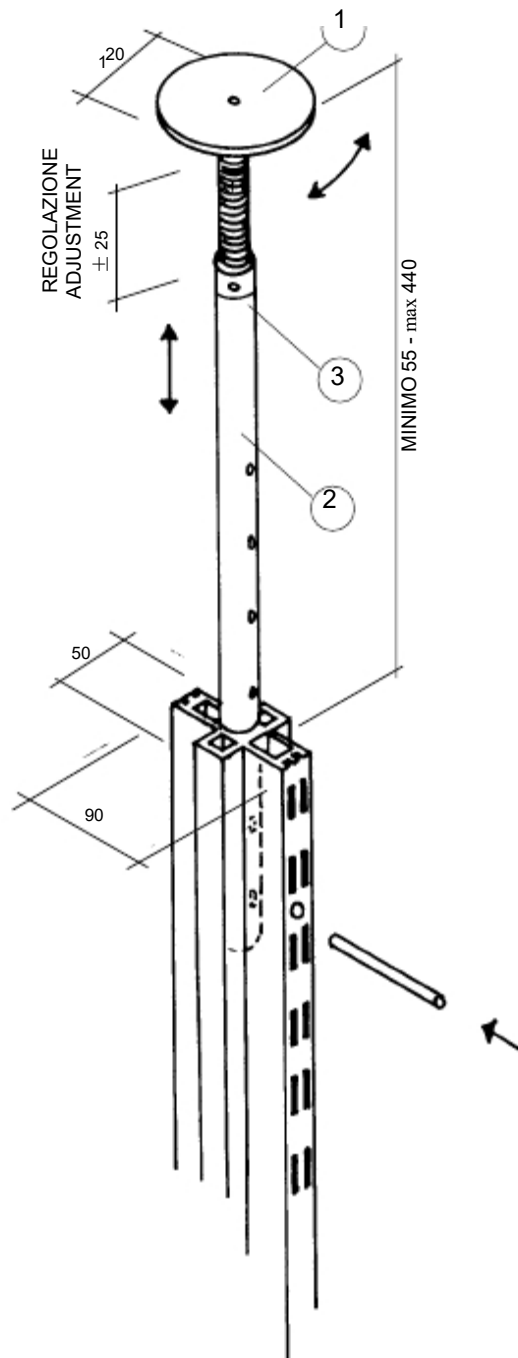

The "CONTINUA CENTRE" bookcase has a structure composed of: central uprights with an adjusting telescopic pusher for fixing to ceiling with a maximal excursion of 385 mm, painted with epoxy powders colours silver, white and black.

Foot and pusher, diameter 120 mm, are always silver colour.

Shelves, shelf brackets and book-ends are the same utilised for "CONTINUA" wall bookcase.

"Centre" upright allows for one side and two side bookcase compositions.

The maximum centre distance between uprights must not exceed 900 mm.



For end compositions, where shelves over-hang from wall upright, the recommended distance is 300 mm.

Maximum recommended carrying weight for aluminium shelves, depth 260/360/460, with centre distance of 900 mm. between wall upright supports: Kg. 40

Maximum recommended carrying weight for aluminium shelves, depth 260/360/460, with centre distance of 750 mm. between wall upright supports: Kg. 60

After loading the bookcase, it is necessary to check the telescopic pusher of the uprights.

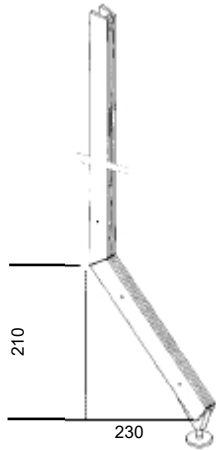

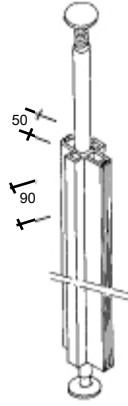
librerie / bookcases

Nome Name	Codice Code	Altezza (mm.) Height (mm.)	EURO
		H (mm.) x P (mm.) 32	
	MON 100	650	65
	MON 101	1035	90
	MON 102	1420	110
	MON 103	1805	130
	MON 104	2190	160
	MON 105	2575	185
		Taglio a misura/Extra cost for cut to size	80
<p>Montante a parete in alluminio verniciato opaco nei colori argento, bianco e nero.</p> <p>Wall upright support made of aluminium, matt lacquered in silver, white and black.</p>			
		H (mm.) x P (mm.) 32	
	MON 106	970	170
	MON 107	1355	185
	MON 108	1740	215
	MON 109	2125	245
	MON 110	2510	275
	MON 111	2895	310
		Taglio a misura/Extra cost for cut to size	80
<p>Montante a parete in alluminio, con appoggio a terra e piedino regolabile, verniciato opaco nei colori argento, bianco e nero.</p> <p>Wall upright support made of aluminium, resting on the floor with adjustable foot, matt lacquered in silver, white and black.</p>			
		H (mm.) x P (mm.) 32	
	MON 112	470	65
	MON 113	855	95
			Taglio a misura/Extra cost for cut to size
<p>Montante a parete in alluminio, Verniciato opaco nei colori argento, bianco e nero per composizioni con due o tre piani.</p> <p>Wall upright support made of aluminium, matt lacquered in silver, white and black. For compositions with two or three shelves.</p>			
		H (mm.) x P (mm.) 90	
	MON 114	2180/2560	620
	MON 115	2560/2950	715
	MON 116	2950/3330	780
<p>Montante centrale con fissaggio a soffitto per mezzo di spintore regolabile, telescopico, con un'escursione massima di mm. 385, verniciato a polveri epossidiche nei colori argento, bianco e nero. Piede e spintore, diametro mm 120, sempre nella finitura argento.</p> <p>Central upright to be fixed to the ceiling with adjustable spindle with a maximal excursion of 385 mm epoxy powders colour silver, white and black. Feet and spindler, diameter 120 mm are always silver colour.</p>			

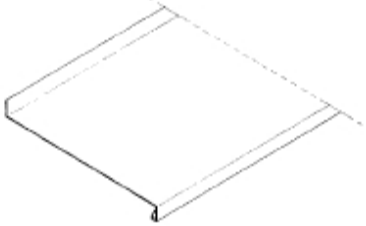
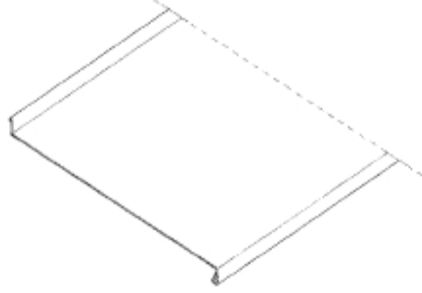
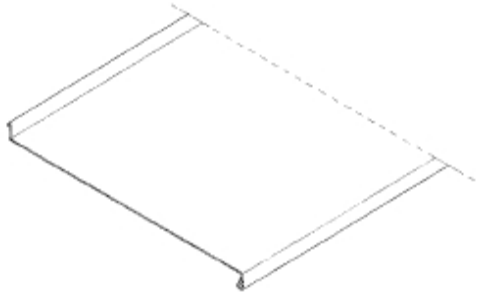
librerie / bookcases

Nome Name	Codice Code	Lunghezza (mm.) Lenght (mm.)	EURO
PIANI ALLUMINIO PROF. 260 mm. SP. 22 mm.			
ALUMINIUM SHELVES DEPTH 260 mm. TH. 22 mm.			
	PIA 100	750	110
	PIA 101	900	125
	PIA 102	1500	180
	PIA 103	1800	200
	PIA 104	2250	210
	PIA 105	2700	260
	PIA 106	3000	275
		Taglio a misura/Extra cost for cut to size	80
	Piano in alluminio verniciato opaco nei colori argento, bianco e nero.	Aluminium shelf, matt lacquered in silver, white and black.	
PIANI ALLUMINIO PROF. 360 mm. SP.22 mm.			
ALUMINIUM SHELVES DEPTH 360 mm. TH. 22 mm.			
	PIA 107	750	130
	PIA 108	900	150
	PIA 109	1500	230
	PIA 110	1800	245
	PIA 111	2250	280
	PIA 112	2700	320
	PIA 113	3000	350
		Taglio a misura/Extra cost for cut to size	80
	Piano in alluminio verniciato opaco nei colori argento, bianco e nero.	Aluminium shelf, matt lacquered in silver, white and black.	
PIANI ALLUMINIO PROF. 460 mm. SP.22 mm.			
ALUMINIUM SHELVES DEPTH 460 mm. TH. 22 mm.			
	PIA 150	750	200
	PIA 151	900	245
	PIA 152	1500	290
	PIA 153	1800	320
	PIA 154	2250	370
	PIA 155	2700	450
	PIA 156	3000	480
		Taglio a misura/Extra cost for cut to size	80
	Piano in alluminio verniciato opaco nei colori argento, bianco e nero.	Aluminium shelf, matt lacquered in silver, white and black.	

librerie / bookcases

Nome Name	Codice Code	Profondità (mm.) Depth (mm.)	EURO
REGGIPIANI PER PIANI ALLUMINIO			
BRACKETS FOR ALUMINIUM SHELVES			
	REP 101/0	260 DX	40
	REP 102/0	360 DX	43
	REP 106/0	460 DX	50
	REP 101/1	260 SX	40
	REP 102/1	360 SX	43
	REP 106/1	460 SX	50
	REP 103/0	260 CX	45
	REP 104/0	360 CX	47
	REP 107/0	460 CX	60
		Reggipiano per piani in alluminio destro, sinistro e centrale in acciaio stampato e verniciato opaco nei colori argento, bianco e nero.	Right side / left side / central shelf bracket for aluminium shelves made of moulded steel, matt lacquered in silver, white and black for steel shelves.

REGGILIBRI PER PIANI ALLUMINIO

BOOKENDS FOR ALUMINIUM SHELVES

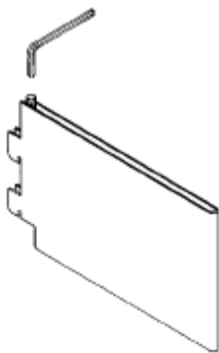

	P (mm.) x H (mm.)	EURO
REL 101/0	240 x 142	50

Reggilibro con bloccaggio in acciaio stampato verniciato nei colori argento, bianco e nero per piani in alluminio, versione unica per prof. 260/360/460.

Book-end with blockage made of moulded steel, matt lacquered in silver, white and black for aluminium shelves, depth 260/360/460.

ESEMPI DI COMPOSIZIONE

EXAMPLES OF COMPOSITION

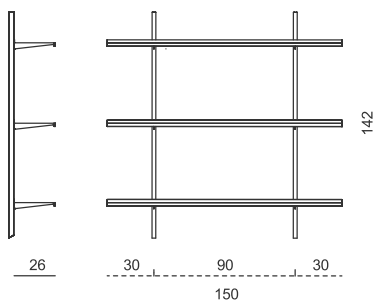

CC005	Piani da 260, montanti a parete da 1420 / Shelves 260, wall uprights 1420	1030
-------	---	------

librerie / bookcases

Nome Name	Codice Code	EURO
--------------	----------------	------

ESEMPI DI COMPOSIZIONE EXAMPLES OF COMPOSITION

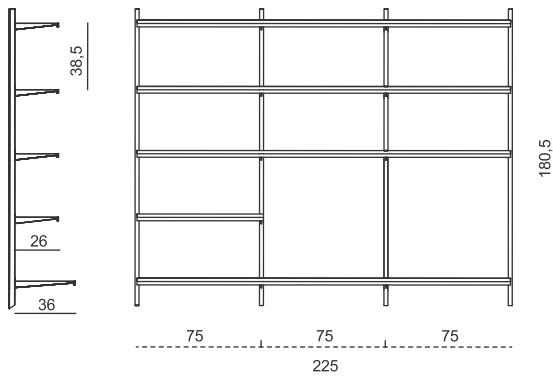

CC010 Piani da 260 e 360, montanti a parete da 1805
Shelves 260 & 360, wall uprights 1805 2.311

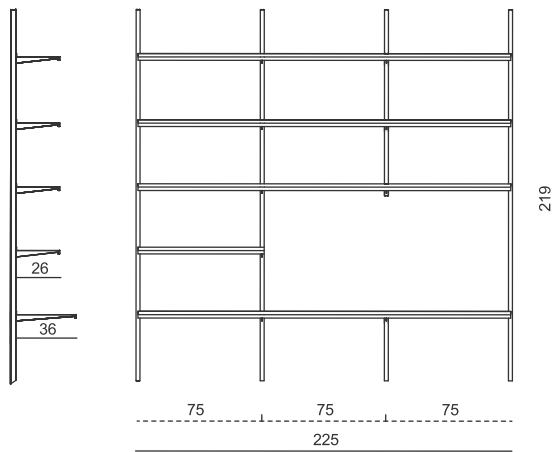

CC011 Piani da 260 e 360, a parete da 2190
Shelves 260 & 360, wall uprights 2190 2.425

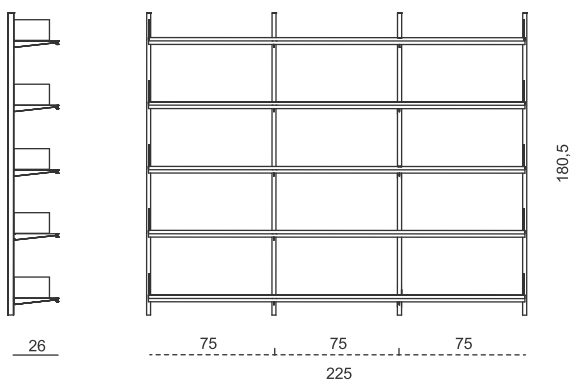

CC031 Piani da 260, montanti a parete da 1805
Shelves 260, wall uprights 1805 2.920

librerie / bookcases

Nome Name	Codice Code	EURO
--------------	----------------	------

ESEMPI DI COMPOSIZIONE EXAMPLES OF COMPOSITION

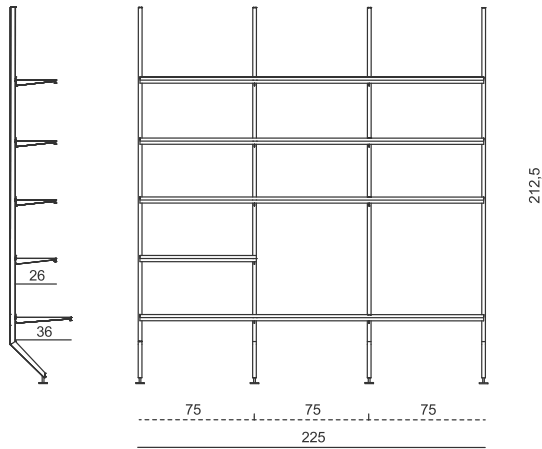

CC012 Piani da 260 e 360, montanti con appoggio a terra da 2125
Shelves 260 & 360 uprights with foot 2125 2.770

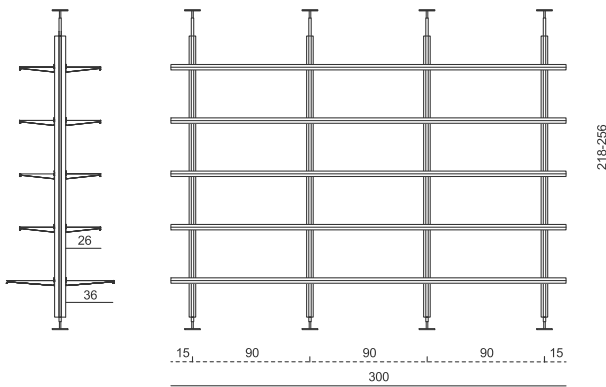

CC300 Piani da 260 e 360, bifacciale
Two side shelves 260 & 360 7.156

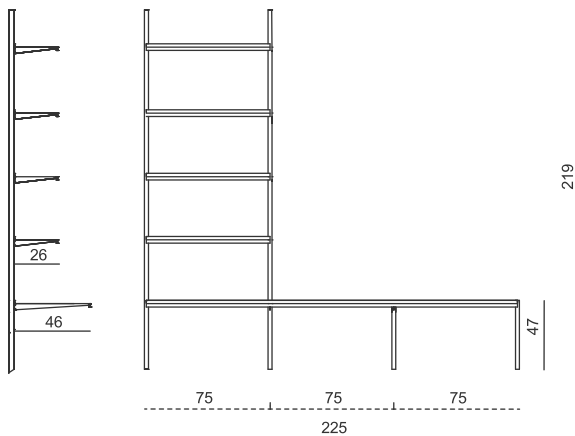

CC040 Piani da 260 e 460, montanti a parete da 2190 e 470
Shelves 260 & 460, wall uprights 2190 & 470 1.800

Nome Name	Codice Code	EURO
--------------	----------------	------

ESEMPI DI COMPOSIZIONE
EXAMPLES OF COMPOSITION

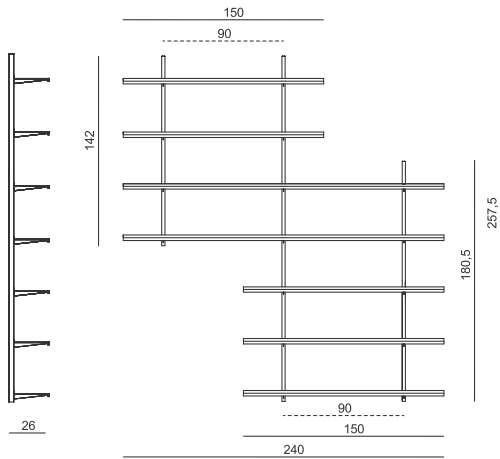

CC050 Piani da 260 montanti a parete da 1420, 2575 e 1805
Shelves 260, wall uprights 1420, 2575 & 1805 2.725

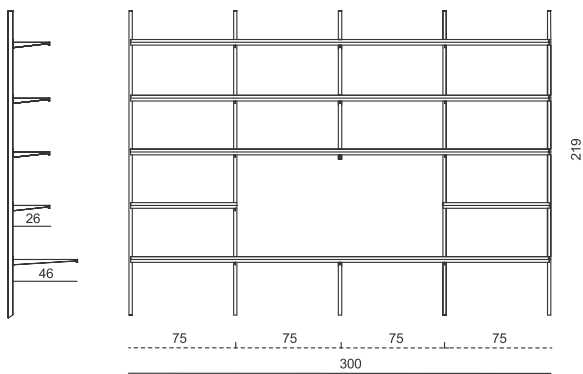

CC060 Piani da 260 e 460, montanti a parete da 2190
Shelves 260 & 460, wall uprights 2190 3.345

indice
index

accessori
accessories

Albero	pag.	60
LaGronda	pag.	61

complementi - forniture

Nome Name	Struttura Frame	Ripiano Shelf	Codice Code	EURO
--------------	--------------------	------------------	----------------	------

ALBERO

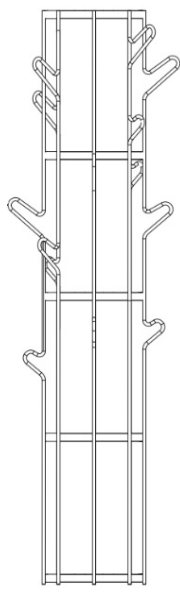

ø 320

1770

metallo verniciato
lacquered metal

rosso
red

legno naturale
natural wood

ALB17732.RD.WD.NA

1.350

antracite
anthracite

legno naturale
natural wood

ALB17732.AN.WD.NA

1.350

bianco
white

legno naturale
natural wood

ALB17732.WH.WD.NA

1.350

complementi - forniture

Nome Name	Struttura Frame	Specchio Mirror	Codice Code	EURO
--------------	--------------------	--------------------	----------------	------

LAGRONDA

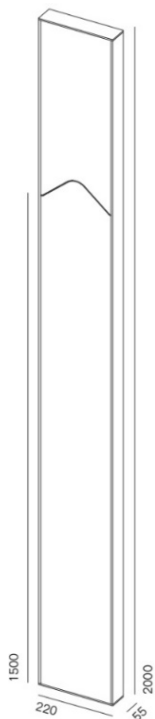

alluminio anodizzato
anodized aluminium

argento
silver

chiaro
clear

LGR20022.AG.NT

430

nero
black

fumè
smoked

LGR20022.BK.FU

430

bronzo perlato
pearly bronze

bronzo
bronze

LGR20022.BP.BR

430

pesi e volumi - weight and volumes

MODELLO MODEL	KG. PESO LORDO GROSS WEIGHT	KG. PESO NETTO NET WEIGHT	MC CBM	mm. LARGHEZZA WIDTH	mm. ALTEZZA HEIGHT	mm. PROFONDITÀ DEPTH	COLLI CRTS
FORTUNY							
CAVALLETTO / STEM	7	6	0,04	1215	195	195	1
PARABOLA / SHADE	17,5	11	0,64	905	585	905	1
FORTUNY PETITE							
CAVALLETTO / STEM	5	4	0,04	1215	195	195	1
PARABOLA / SHADE	12,5	9	0,31	745	475	745	1
PAPIRO H. 220 CM LED							
	15	13	0,14	250	1110	460	1
PAPIRO H. 270 CM LED							
	16	14	0,16	250	1380	460	1
GILDA TERRA/FLOOR							
CAVALLETTO / STEM	3	2	0,01	120	800	120	1
PARALUME / SHADE	10	9	0,39	750	720	730	1
BABY GILDA							
CAVALLETTO / STEM	1,5	1	0,02	170	540	170	1
PARALUME / SHADE	2,6	1,3	0,13	550	420	550	1
FARO NEXT							
STRUTTURA / STRUCTURE	3	2	0,02	100	1670	120	1
PARABOLA / SHADE	7	6	0,19	600	530	600	1
PARABOLA LED / LED SHADE	8	7	0,19	600	530	600	1
GLOW SOSPENSIONE 1 / PENDANT 1							
DIFFUSORE / SHADE	6	4	0,21	800	460	580	1
BARRA / METAL TRACK	2	1	0,01	240	220	210	1
GLOW SOSPENSIONE 2 / PENDANT 2							
DIFFUSORE / SHADE	6	4	0,21	800	460	580	2
BARRA / METAL TRACK	5	3,5	0,03	700	210	200	1
FOLD SOSPENSIONE MEDIA / MEDIUM PENDANT							
	12	9	0,18	1020	430	410	1
FOLD SOSPENSIONE GRANDE / BIG PENDANT							
	19	17	0,20	1020	430	410	1
FOLD APPLIQUE PICCOLA / SMALL WALL							
	3	4	0,08	1020	430	410	1

pesi e volumi - weight and volumes

MODELLO MODEL	KG. PESO LORDO GROSS WEIGHT	KG. PESO NETTO NET WEIGHT	MC CBM	mm. LARGHEZZA WIDTH	mm. ALTEZZA HEIGHT	mm. PROFONDITÀ DEPTH	COLLI CRTS
CORAL TERRA / FLOOR MM.600							
DIFFUSORE / SHADE	12,5	7	0,60	830	870	830	1
STRUTTURA / STRUCTURE	22	20	0,35	480	1540	480	1
CORAL SOSPENSIONE / PENDANT MM.600							
	14	8	0,60	830	870	830	1
CORAL TERRA - TAVOLO / FLOOR - TABLE MM.600							
DIFFUSORE / SHADE	12,5	7	0,60	830	870	830	1
BASE / BASE	10	8	0,11	460	490	480	1
CRINOLINA SOSPENSIONE / PENDANT MM.550							
DIFFUSORE / SHADE	7	1	0,22	600	600	600	1
STRUTTURA / STRUCTURE	2	1,5	0,01	220	280	220	1
EGG TAVOLO / TABLE							
	10	8	0,18	570	530	610	1
EGG SOSPENSIONE / PENDANT							
	10	8	0,18	570	530	610	1
ROCK GARDEN							
STRUTTURA / FRAME 1250	6	5	0,06	1340	110	430	1
STRUTTURA / FRAME 1550	8	6	0,08	1610	110	430	1
SPOT / PENDANT SPOT	3	2	0,11	480	510	430	1
1 PIRAMIDE / 1 PYRAMID single	2	1	0,08	400	470	430	1
ALEXANDRA							
SOSPENSIONE 1 / PENDANT 1	8	4	0,24	1260	230	840	1
SOSPENSIONE 3 / PENDANT 3	20	6	0,45	1900	230	1030	1
LONG SOSPENSIONE 1 / LONG PENDANT 1	8	4	0,24	1260	230	840	1
LONG SOSPENSIONE 3 / LONG PENDANT 3	20	6	0,45	1900	230	1030	1
RING 600							
	5	4	0,07	520	270	520	1
RING 800							
	8	7	0,14	720	270	720	1
RING 800 MIX							
	9	8	0,25	650	600	650	1
RING SPHERE							
	5	3	0,10	500	500	400	1
GRID							
SOSPENSIONE 300 / PENDANT 300	4	3	0,04	360	360	300	1
SOSPENSIONE 600 / PENDANT 600	9	7	0,19	660	660	430	1
TERRA/TAVOLO 300 / FLOOR/TABLE 300	7	6	0,05	360	360	400	1

pesi e volumi - weight and volumes

MODELLO MODEL	KG. PESO LORDO GROSS WEIGHT	KG. PESO NETTO NET WEIGHT	MC CBM	mm. LARGHEZZA WIDTH	mm. ALTEZZA HEIGHT	mm. PROFONDITÀ DEPTH	COLLI CRTS
GRAFFITI							
SOSPENSIONE/PENDANT 1800	6	5	0,07	2200		Ø100	1
SOSPENSIONE/PENDANT 2400	8	7	0,09	2800		Ø100	1
APPLIQUE 900	4	3	0,02	70	1000	250	1
APPLIQUE 1200	5	4	0,02	70	1300	250	1
RANY DAY							
	6	5	0,07	560	210	580	1
CALLA							
PICCOLA / SMALL	11	10	0,37	480	1600	480	1
GRANDE / BIG	11	10	0,37	480	1600	480	1
MICRO TELESCOPIC COMPOSIZIONE/COMPOSITION 1.3							
DIFFUSER / LAMPSHADE	4	3,5	0,03	160	1200	140	1
ROSONE / CEILING PLATE	1,4	1	0,01	200	180	200	1
MICRO TELESCOPIC COMPOSIZIONE/COMPOSITION 1.4							
DIFFUSER / LAMPSHADE	4,5	4	0,03	160	1200	140	1
ROSONE / CEILING PLATE	1,4	1	0,01	200	180	200	1
MICRO TELESCOPIC COMPOSIZIONE/COMPOSITION 2.3							
DIFFUSER / LAMPSHADE	4	3,5	0,03	160	1200	140	2
ROSONE / CEILING PLATE	1,4	1	0,01	200	180	200	1
MICRO TELESCOPIC COMPOSIZIONE/COMPOSITION 2.4							
DIFFUSER / LAMPSHADE	4,5	4	0,03	160	1200	140	2
ROSONE / CEILING PLATE	1,4	1	0,01	200	180	200	1
MICRO TELESCOPIC COMPOSIZIONE/COMPOSITION 3.3							
DIFFUSER / LAMPSHADE	4	3,5	0,03	160	1200	140	3
ROSONE / CEILING PLATE	1,4	1	0,01	200	180	200	1
MICRO TELESCOPIC COMPOSIZIONE/COMPOSITION 3.4							
DIFFUSER / LAMPSHADE	4,5	4	0,03	160	1200	140	3
ROSONE / CEILING PLATE	1,4	1	0,01	200	180	200	1
MICRO TELESCOPIC TERRA/FLOOR							
DIFFUSER / LAMPSHADE	4,5	4	0,03	160	1200	140	1
BASE	15	14	0,03	480	150	480	1

pesi e volumi - weight and volumes

MODELLO MODEL	KG. PESO LORDO GROSS WEIGHT	KG. PESO NETTO NET WEIGHT	MC CBM	mm. LARGHEZZA WIDTH	mm. ALTEZZA HEIGHT	mm. PROFONDITÀ DEPTH	COLLI CRTS
TANGENT							
MINI	2	1	0,02	610	220	140	1
MEDIA	12	10	0,08	320	1610	160	1
DIFFUSORE XL / XL SHADE	15	12	0,22	420	2350	220	1
STRUTTURA XL / XL STRUCTURE	29	26	0,05	530	170	530	1
TOTEM							
STRUTTURA 60 / STRUCTURE 60	2	1,8	0,01	700		Ø100	1
STRUTTURA 90 / STRUCTURE 90	3	2,6	0,01	1000		Ø100	1
STRUTTURA 120 / STRUCTURE 120	4	3,5	0,01	1300		Ø100	1
STRUTTURA 200 / STRUCTURE 200	6,5	5,8	0,02	2100		Ø100	1
COMPONENTS	2~5	1~4	0,01	430	100	280	1
TUBE 2.0							
	4	2,5	0,02	2000		Ø100	1

Export sales conditions

Delivery terms

Delivery terms are reported in the order confirmation and should be considered as just an indication of the date in which goods are ready to be collected by the forwarding agents or transporters.

We do not accept penalties and / or cancellation of the order due to delay in delivery.

Complaints

Claims for any sort of manufacturing damage and / or manufacturing defect are accepted only if duly advised by the Client and through registered letter within and not later than 8 days from the delivery date.

Transport claims

Claim for transport damages will be accepted only if noted in the form and sent to Pallucco s.a.s. di Lando Lino & C. in writing within 7 days from delivery.

Returns

Returns are not accepted unless previously authorized by our company.

Guarantee

All our products are guaranteed up to 12 months from delivery date in the event of manufacturing defects, after such date we will no longer be responsible for any repairs. Guarantee does not include damages caused by improper use.

Failure to pay

Unpaid invoices will entitle Pallucco s.a.s. di Lando Lino & C. to claim interests from date when payment falls due, until date of full settlement.

Modifications

Pallucco s.a.s. di Lando Lino & C. reserves the right to modify and improve models either technically or esthetically without warning.

We reserve the right to alter prices and or specification without prior notice.

Tolerance

Colours used for materials, paints etc. are only indicative as it is not possible to technically or esthetically ensure a constant colouring over a period of time. It is assumed that the customer agrees to accept colour tolerance when orders are placed.

Competence

In the event of any controversy the competent authority will be exclusively the Law Court of Venice, Italy.

Transportation costs

Unless otherwise stated, shipping is ex works. Goods are collected from Pallucco s.a.s. di Lando Lino & C. headquarters, freight, customs and handling charges are at purchaser's expense.

The consignee must verify the weight of the goods, number of pieces and state of packaging before signing for acceptance and if necessary communicate complaints to the carrier or shipper, since the latter are responsible for damage or loss which may in no way be blamed on the supplier.

Transport Austria, Belgium, Germany, France, Holland, Switzerland, Spain (islands excl.)

The goods will be delivered without any freight expenses for minimum order net of Euro 700 - Otherwise 45 Euro are charged as freight costs. Weight, number of packages and condition of the goods must be checked before acceptance. In case of damages you have to put a reserve note on the shipping document.

Transport Great Britain, Portugal

The goods will be delivered without any freight expenses for minimum order net of Euro 1.200 - Otherwise 85 Euro are charged as freight costs. Weight, number of packages and condition of the goods must be checked before acceptance. In case of damages you have to put a reserve note on the shipping document.

Transport to islands to be quoted.

Images ad company logo Pallucco can be used on the web only after authorization by Pallucco s.a.s.

di Lando Lino & C. Pallucco deserves to confirm possible orders within 60 days from receipt.

In case no confirmation is sent within a.b. terms, the order shall be considered as non accepted.

legenda



Prodotto rispondente ai requisiti previsti dalle norme europee EN 60598
Product complies to CE norms and regulations



CLASSE II Apparecchio in cui la protezione contro la scossa elettrica si basa unicamente sul doppio isolamento e/o isolamento rinforzato in ogni parte e senza dispositivo di messa a terra.
Light fittings whose safety is guaranteed only by the double and/ or reinforced insulation of all parts, with no earth.

Condizioni generali di vendita ITALIA

Listino prezzi al pubblico iva esclusa.

Termini di consegna

I termini di consegna esposti nelle conferme d'ordine hanno unicamente valore indicativo ed in ogni caso si riferiscono alla data di consegna allo spedizioniere o vettore. Non si accettano penalità né responsabilità per ritardata consegna.

Trasporti

La merce viaggia franco magazzino del cliente solo per ordini superiori a EURO 700 + IVA.
Porto assegnato con addebito del trasporto in fattura per ordini inferiori alle cifre sopraindicate per categoria di EURO 35 + IVA. Spetta al destinatario verificare il peso della merce, il numero dei colli e lo stato dell'imballaggio prima del ritiro e fare dovute riserve al vettore o allo spedizioniere, essendo questi ultimi responsabili di mancanze o avarie, che non potranno in alcun modo e per nessuna ragione essere imputate alla fornitrice.

Reclami

Si accettano reclami per eventuali danneggiamenti di trasporto o difetti di fabbricazione solo se comunicati a mezzo lettera raccomandata entro 8 giorni dalla data di ricevimento della merce o apponendo riserva direttamente sulla bolla se l'imballo è danneggiato visibilmente.

Resi

Non si accettano resi se non preventivamente concordati ed autorizzati dalla nostra società.

Garanzia

Tutti i prodotti sono garantiti, per eventuali difetti di fabbricazione, fino a 1 anno dalla data di consegna, oltre tale data, qualsiasi riparazione sarà a carico del cliente. Sono automaticamente esclusi dalla garanzia tutti i prodotti che siano stati:

- manomessi
- usati impropriamente.

Pagamento

Ricevuta bancaria 60 gg. fm.
Altri pagamenti da concordare.

Insoluti

Il ritorno di R.B. insolute dà luogo all'addebito delle spese di ritorno e degli interessi bancari per il ritardato pagamento, nonché alla immediata sospensione delle spedizioni in corso.

Modifiche

La Pallucco s.a.s. di Lando Lino & C. si riserva la facoltà di apportare modifiche e migliorie di carattere tecnico o estetico ai modelli senza preavviso.

Tolleranza

I colori delle verniciature, ecc. sono soltanto indicativi, non essendo possibile tecnicamente assicurare la costanza di tinta a distanza di tempo. Il committente, conferendo ordini, accetta tali tolleranze di colore.

Competenze

Per qualsiasi controversia sarà competente unicamente il Foro di Venezia.

Le immagini e il logo aziendale possono essere utilizzati sul web solo previa autorizzazione da parte di Pallucco s.a.s. di Lando Lino & C.

La Pallucco s.a.s. di Lando Lino & C. si riserva di confermare eventuali ordini entro 60 giorni dalla ricezione.

In caso di mancata accettazione espressa entro il suddetto termine, l'ordine si riterrà rifiutato.

Images ad company logo can be used on the web only after authorization by Pallucco s.a.s. di Lando Lino & C.

Pallucco s.a.s. di Lando Lino & C. deserves to confirm possible orders within 60 days from receipt.

In case no confirmation is sent within a.b. terms, the order shall be considered as non accepted.

Note

Note

Note

Note

Pallucco s.a.s. di Lando Lino & C.

Registered Office
San Marco – N°4670
30124 Venezia, Italy

Headquarters
Via Meucci – N°4
31022 Preganziol
Treviso, Italy

Commerciale Italia
T +39 0422 43 86 00
F +39 0422 43 85 55

International Sales Department
T +39 0422 43 86 22
F +39 0422 43 85 55

info@pallucco.com
www.pallucco.com