

PRICELIST 2021 – 2022

Harco Loor Design has been founded in the early 80's as a result of growing interest and significance of design in the international field of interior lighting.

Each design is hand crafted and carries the personal signature of the designer Harco Loor.

All our lighting are designed and manufactured in our own factory in Haarlem, The Netherlands.

Only high quality materials, such as stainless steel and crystal are used. Now, innovative energy saving solutions are integrated into our designs.

On request modifications or other measurements are possible.

HARCO LOOR DESIGN OFFICE

Tappersweg 81-83
2031 ET Haarlem
The Netherlands

P.O. Box 6145
2001 HC Haarlem
The Netherlands

+31 (0)23 538 81 17
info@harcoloor.com
www.harcoloor.com

SHOWROOM

Gedempte Oude Gracht 74
2011 GT Haarlem
+31 (0)23 538 81 17

SUSPENSION

6 BALLOON/BALLOON CABLE
8 BIG BUBBLES
BIG BUBBLES KITE
BIG BUBBLES LONG
BIG BUBBLES OVAL
14 BREEZE
BREEZE OVAL
18 BUBBLES
BUBBLES KITE
BUBBLES LONG
BUBBLES OVAL
24 CLUSTER/CLUSTER CABLE
CLUSTER OVAL
CLUSTER CROWN
CLUSTER CROWN OVAL
CLUSTER WHEEL
32 CROSSFIRE/CROSSFIRE CABLE
CROSSFIRE LARGE
CROSSFIRE OVAL LARGE
CROSSFIRE WHEEL LARGE
36 CRYSTAL
38 FLAG
FLAG OVAL

40 FLOWER
FLOWER LARGE
40 JELLY
46 JEWEL
JEWEL CHANDELIER
JEWEL CHANDELIER OVAL
JEWEL OVAL
JEWEL KITE
54 METEOR LARGE
METEOR LARGE OVAL
56 MURRINI
MURRINI OVAL
58 SNOWBALL
SNOWBALL OVAL
64 STRAWBERRY
STRAWBERRY OVAL
68 SWEET
SWEET OVAL
74 TIARA
TIARA CHANDELIER
TIARA OVAL
TIARA KITE

CEILING/WALL

6 BALLOON
8 BIG BUBBLES
14 BREEZE
16 BUBBLES
24 CLUSTER
CLUSTER OVAL
CLUSTER CROWN
CLUSTER WHEEL
32 CROSSFIRE
CROSSFIRE LARGE
CROSSFIRE OVAL LARGE
CROSSFIRE WHEEL LARGE
36 CRYSTAL
38 FLAG
FLAG OVAL

FLOOR

46 JEWEL
JEWEL LONG
52 METEOR
METEOR LARGE
METEOR WHEEL
56 MURRINI
MURRINI LONG
58 SNOWBALL
64 STRAWBERRY
68 SWEET
SWEET LONG
72 TARGET
74 TIARA
TIARA OVAL
TIARA LONG

8 BIG BUBBLES
14 BREEZE
16 BUBBLES
BUBBLES LONG
BUBBLES SP.
24 CLUSTER
40 FLOWER
FLOWER LARGE
40 HOOD
40 JELLY
52 METEOR
56 MURRINI
32 PENNE
58 SNOWBALL
64 STRAWBERRY
68 SWEET
82 TREE BREEZE
TREE FLAG
WING

TABLE

14 BREEZE
16 BUBBLES SP.
24 CLUSTER
40 FLOWER
FLOWER LARGE
40 HOOD
40 JELLY
46 JEWEL
52 METEOR
56 MURRINI
58 SNOWBALL
64 STRAWBERRY
68 SWEET



BALLOON CABLE

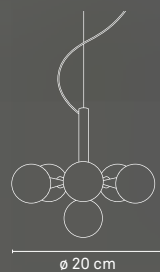

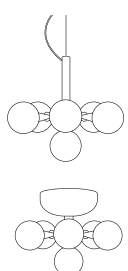
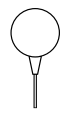
DESIGNS	TYPE	TECHN. LED BULB				DIMENSION		PARTS	PRICE
	HL 6	12 V	1W LED	130LM	2700K	G4	↓ ** cm		€ 399
	HL 13	12 V	1W LED	130LM	2700K	G4	↓ ** cm		€ 749
	PL 6	12 V	1W LED	130LM	2700K	G4	↓ 20 cm	GBA	€ 399
	PL 9	12 V	1W LED	130LM	2700K	G4	↓ 42 cm		€ 599
						3 mm - inox			

cable ↓
var. st. 200 cm

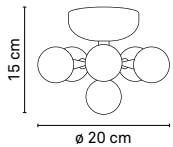

HARCO LOOR DESIGN

8

HL 35

BIG BUBBLES



ø 280 cm



BIG BUBBLES

HARCO LOOR DESIGN

10







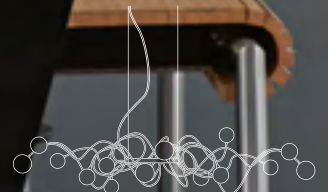

HL 14



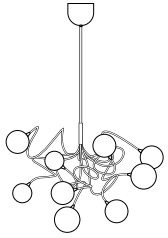
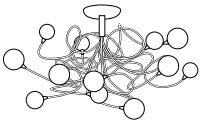

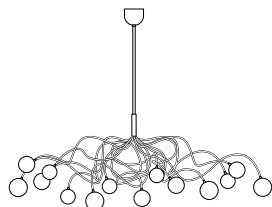

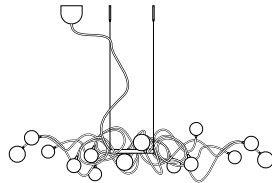

BIG BUBBLES KITE

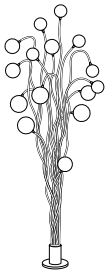

160 x 45 cm

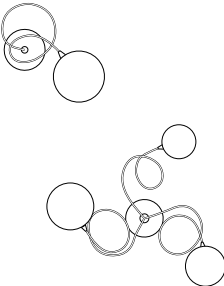
DESIGNS	TYPE	TECHN. LED BULB	DIMENSION	PARTS	PRICE		
BIG BUBBLES  	HL 10	12 V 1W LED 130LM 2700K G4	100 ↓ ** cm	 GBU-M+L	€ 950		
	HL 14	12 V 1W LED 130LM 2700K G4	110 ↓ ** cm		€ 1290		
	HL 20	12 V 1W LED 130LM 2700K G4	150 ↓ ** cm		€ 1995		
	HL 24	12 V 1W LED 130LM 2700K G4	190 ↓ ** cm		€ 2390		
	HL 30	12 V 1W LED 130LM 2700K G4	250 ↓ ** cm		€ 2880		
	HL 35	12 V 1W LED 130LM 2700K G4	280 ↓ ** cm		€ 3200		
	PL 10	12 V 1W LED 130LM 2700K G4	100 ↓ 30 cm		€ 950		
	PL 14	12 V 1W LED 130LM 2700K G4	110 ↓ 40 cm		€ 1290		
	PL 20	12 V 1W LED 130LM 2700K G4	150 ↓ 50 cm		€ 1995		
	PL 24	12 V 1W LED 130LM 2700K G4	190 ↓ 50 cm		€ 2390		
	PL 30	12 V 1W LED 130LM 2700K G4	250 ↓ 50 cm		€ 2880		
	PL 35	12 V 1W LED 130LM 2700K G4	280 ↓ 50 cm		€ 3200		
					6 mm - inox		
	BIG BUBBLES OVAL 	HL 10	12 V 1W LED 130LM 2700K G4		110 x 50 cm	 GBU-M+L	€ 950
HL 14		12 V 1W LED 130LM 2700K G4	140 x 50 cm	€ 1290			
HL 20		12 V 1W LED 130LM 2700K G4	170 x 70 cm	€ 1995			
HL 24		12 V 1W LED 130LM 2700K G4	180 x 70 cm	€ 2390			
HL 30		12 V 1W LED 130LM 2700K G4	200 x 70 cm	€ 2880			
HL 35		12 V 1W LED 130LM 2700K G4	250 x 100 cm	€ 3200			
			6 mm - inox				
BIG BUBBLES KITE 	HL 10	12 V 1W LED 130LM 2700K G4	130 x 40 cm	 GBU-M+L	€ 999		
	HL 14	12 V 1W LED 130LM 2700K G4	160 x 45 cm		€ 1295		
	HL 18	12 V 1W LED 130LM 2700K G4	180 x 45 cm		€ 1695		
			‡ var. st. 200 cm				
			6 mm - inox				

DESIGNS	TYPE	TECHN. LED BULB	DIMENSION	PARTS	PRICE
BIG BUBBLES 	FL 7 FL 10 FL 15	12 V 1W LED 130LM 2700K G4 12 V 1W LED 130LM 2700K G4 12 V 1W LED 130LM 2700K G4	† 170 cm † 175 cm † 195 cm	 6 mm - inox GBU-M+L	€ 995 € 1269 € 1599
BIG BUBBLES LONG 	HL 20	12 V 1W LED 130LM 2700K G4	∅ 50 † 200 cm	 6 mm - inox GBU-M+L	€ 1995
BIG BUBBLES 	PL/WL 1 PL/WL 3 PL/WL 5	12 V 1.5W LED 200LM 2700K G4 12 V 1.5W LED 200LM 2700K G4 12 V 1W LED 130LM 2700K G4	∅ 30 ↔ 25 cm ∅ 40 ↔ 25 cm ∅ 50 ↔ 25 cm	 3 mm - inox GBU-M+L	€ 179 € 345 € 499

12



13

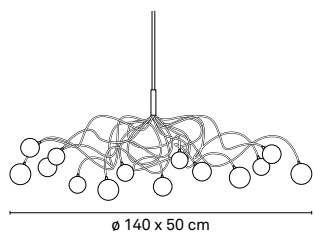

HL 14

BIG BUBBLES OVAL

HARCO LOOR DESIGN

14

FL 9



BREEZE



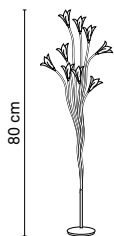

15

FL 9

BREEZE

DESIGN HARCO LOOR







16

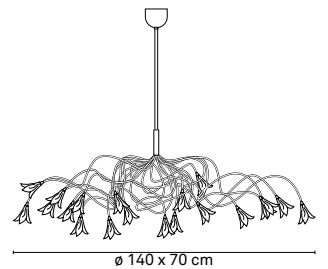

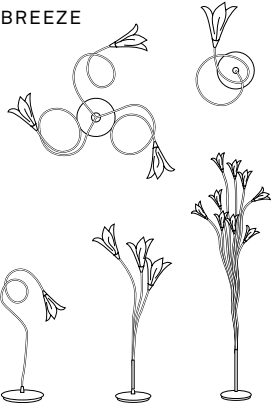

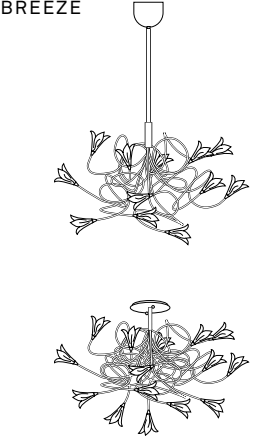

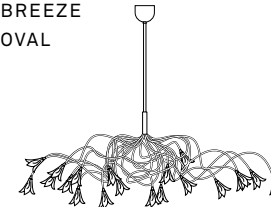

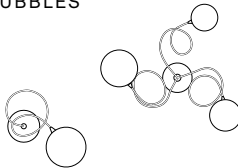

HL 20

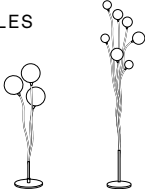
BREEZE OVAL

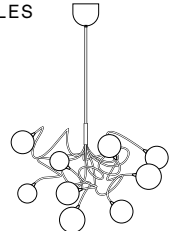
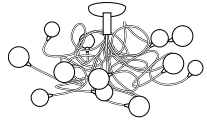

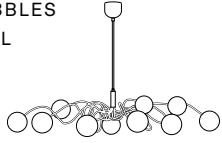
DESIGNS	TYPE	TECHN. LED BULB	DIMENSION	PARTS	PRICE	
BREEZE 	WL/PL 1	12 V 1.5W LED 200LM 2700K G4	∅ 20 ⇄ 20 cm	 BRM	€ 149	
	WL/PL 3	12 V 1.5W LED 200LM 2700K G4	∅ 30 ⇄ 20 cm		€ 299	
	WL/PL 5	12 V 1W LED 130LM 2700K G4	∅ 40 ⇄ 25 cm		€ 399	
					3 mm - inox	
	TL 1	12 V 1W LED 130LM 2700K G4	↓ 45 cm		€ 159	
	TL 3	12 V 1W LED 130LM 2700K G4	↓ 60 cm		€ 299	
	TL 6	12 V 1W LED 130LM 2700K G4	↓ 80 cm		€ 499	
	FL 9	12 V 1W LED 130LM 2700K G4	↓ 175 cm		€ 799	
	FL 12	12 V 1W LED 130LM 2700K G4	↓ 195 cm		€ 999	
					3 mm - inox	
BREEZE 	HL 7	12 V 1W LED 130LM 2700K G4	∅ 70 ↓ ** cm	 BRM	€ 569	
	HL 9	12 V 1W LED 130LM 2700K G4	∅ 80 ↓ ** cm		€ 699	
	HL 12	12 V 1W LED 130LM 2700K G4	∅ 90 ↓ ** cm		€ 899	
	HL 15	12 V 1W LED 130LM 2700K G4	∅ 120 ↓ ** cm		€ 1299	
	HL 20	12 V 1W LED 130LM 2700K G4	∅ 140 ↓ ** cm		€ 1795	
	PL 7	12 V 1W LED 130LM 2700K G4	∅ 60 ↓ 30 cm		€ 569	
	PL 9	12 V 1W LED 130LM 2700K G4	∅ 70 ↓ 30 cm		€ 699	
	PL 12	12 V 1W LED 130LM 2700K G4	∅ 80 ↓ 30 cm		€ 899	
	PL 15	12 V 1W LED 130LM 2700K G4	∅ 120 ↓ 40 cm		€ 1299	
	PL 20	12 V 1W LED 130LM 2700K G4	∅ 140 ↓ 40 cm		€ 1795	
			3 mm - inox			
BREEZE OVAL 	HL 12	12 V 1W LED 130LM 2700K G4	∅ 120 x 50 cm	 BRM	€ 899	
	HL 15	12 V 1W LED 130LM 2700K G4	∅ 130 x 60 cm		€ 1249	
	HL 20	12 V 1W LED 130LM 2700K G4	∅ 140 x 70 cm		€ 1795	
					3 mm - inox	

DESIGNS	TYPE	TECHN. LED BULB	DIMENSION	PARTS	PRICE
BUBBLES 	WL/PL 1 WL/PL 3 WL/PL 5	12 V 1.5W LED 200LM 2700K G4 12 V 1.5W LED 200LM 2700K G4 12 V 1W LED 130LM 2700K G4	∅ 20 ⇨ 25 cm ∅ 40 ⇨ 25 cm ∅ 50 ⇨ 35-50 cm 3 mm - inox	 GBU-S+M	€ 159 € 299 € 399
BUBBLES SP. 	TL 3 TL 6 FL 7	12 V 1.5W LED 200LM 2700K G4 12 V 1W LED 130LM 2700K G4 12 V 1W LED 130LM 2700K G4	‡ 65 cm ‡ 85 cm ‡ 170 cm 3 mm - inox	 GBU-S+M	€ 369 € 499 € 799
BUBBLES  	HL 7 HL 9 HL 12 HL 15 HL 20 PL 7 PL 9 PL 12 PL 15 PL 20	12 V 1W LED 130LM 2700K G4 12 V 1W LED 130LM 2700K G4 12 V 1W LED 130LM 2700K G4 12 V 1W LED 130LM 2700K G4 12 V 1W LED 130LM 2700K G4 12 V 1W LED 130LM 2700K G4 12 V 1W LED 130LM 2700K G4 12 V 1W LED 130LM 2700K G4 12 V 1W LED 130LM 2700K G4 12 V 1W LED 130LM 2700K G4	∅ 65 ↓ ** cm ∅ 70 † ** cm ∅ 80 † ** cm ∅ 100 † ** cm ∅ 120 † ** cm ∅ 65 ↓ 30 cm ∅ 70 ↓ 30 cm ∅ 80 ↓ 30 cm ∅ 100 ↓ 40 cm ∅ 120 ↓ 40 cm 3 mm - inox	 GBU-S+M	€ 569 € 699 € 879 € 1249 € 1795 € 569 € 699 € 879 € 1249 € 1795
BUBBLES OVAL 	HL 12 HL 15	12 V 1W LED 130LM 2700K G4 12 V 1W LED 130LM 2700K G4	∅ 130 x 40 cm ∅ 160 x 70 cm 3 mm - inox	 GBU-S+M	€ 879 € 1249

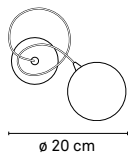
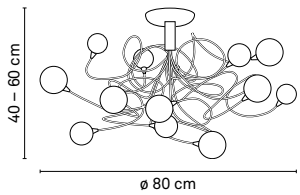

BUBBLES

BUBBLES LONG

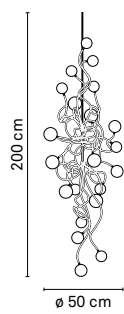



21

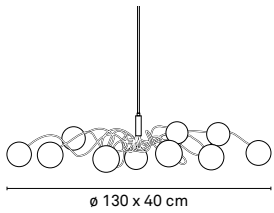

HL 12







BUBBLES OVAL

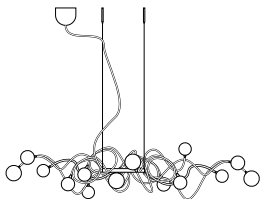

BUBBLES KITE

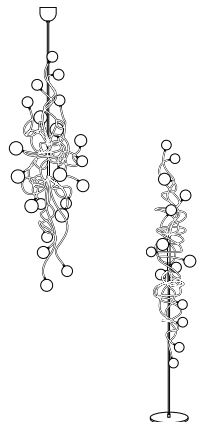

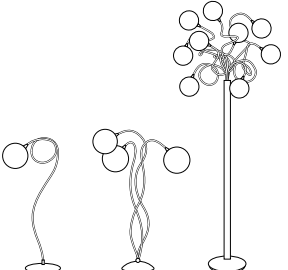
ø 125 x 25 cm

DESIGNS	TYPE	TECHN. LED BULB	DIMENSION	PARTS	PRICE
BUBBLES KITE 	HL 10	12 V 1W LED 130LM 2700K G4	↔ 100 x 20 cm	 GBU-S+M	€ 999
	HL 14	12 V 1W LED 130LM 2700K G4	↔ 125 x 25 cm		€ 1220
	HL 18	12 V 1W LED 130LM 2700K G4	↔ 150 x 30 cm		€ 1795
			‡ var. st. 200 cm		
			3 mm - inox		
BUBBLES LONG 	HL 14	12 V 1W LED 130LM 2700K G4	∅ 30 ‡ 125 cm	 GBU-S+M	€ 1299
	HL 18	12 V 1W LED 130LM 2700K G4	∅ 35 ‡ 150 cm		€ 1749
	HL 24	12 V 1W LED 130LM 2700K G4	∅ 50 ‡ 200 cm		€ 2195
			‡ on order		
			3 mm - inox		
BUBBLES 	TL 1	12 V 1.5W LED 130LM 2700K G4	‡ 55 cm	 GBU-S+M	€ 185
	TL 3	12 V 1.5W LED 130LM 2700K G4	‡ 70 cm		€ 390
	TL 5	12 V 1W LED 130LM 2700K G4	‡ 75 cm		€ 460
	FL 7	12 V 1W LED 130LM 2700K G4	‡ 170 cm		€ 799
	FL 9	12 V 1W LED 130LM 2700K G4	‡ 175 cm		€ 999
			3 mm - inox		



CLUSTER

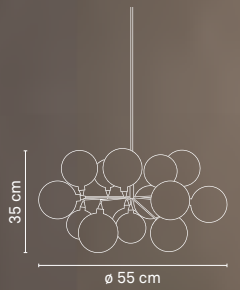



25

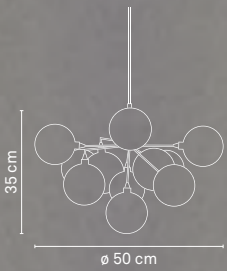





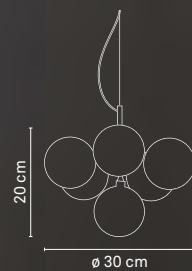

HL 11

CLUSTER

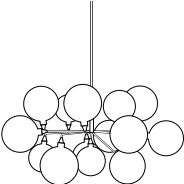

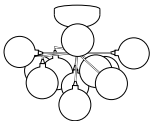
CLUSTER CABLE

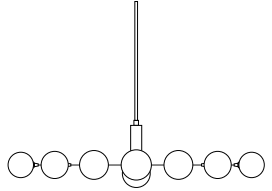

DESIGNS	TYPE	TECHN. LED BULB	DIMENSION	PARTS	PRICE
CLUSTER / CLUSTER CABLE 	HL 4	12 V 1W LED 130LM 2700K G4	∅ 30 † ** cm	 GBU-L	€ 325
	HL 6	12 V 1W LED 130LM 2700K G4	∅ 30 † ** cm		€ 499
	HL 11	12 V 1W LED 130LM 2700K G4	∅ 50 † ** cm		€ 879
	HL 16	12 V 1W LED 130LM 2700K G4	∅ 55 † ** cm		€ 1299
CLUSTER 	WL/PL 4	12 V 1W LED 130LM 2700K G4	∅ 30 † 20 cm	 GBU-L	€ 325
	WL/PL 6	12 V 1W LED 130LM 2700K G4	∅ 30 † 20 cm		€ 499
	PL 11	12 V 1W LED 130LM 2700K G4	∅ 50 † 35 cm		€ 879
CLUSTER OVAL 	HL 13	12 V 1W LED 130LM 2700K G4	∅ 120 x 50 cm	 GBU-L	€ 1250
	HL 17	12 V 1W LED 130LM 2700K G4	∅ 155 x 55 cm		€ 1595
	PL 13	12 V 1W LED 130LM 2700K G4	∅ 120 x 50 cm		€ 1250
	PL 17	12 V 1W LED 130LM 2700K G4	∅ 155 x 55 cm		€ 1595
			6 mm - inox		

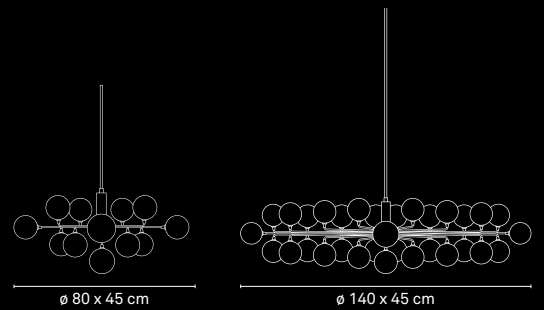

CLUSTER CROWN



29

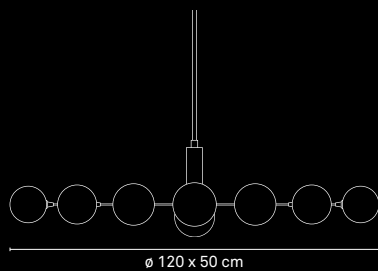

ø 120 x 50 cm







HL 13

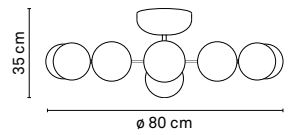

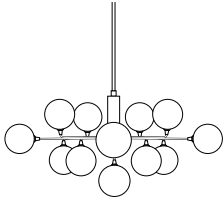

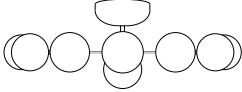
CLUSTER OVAL

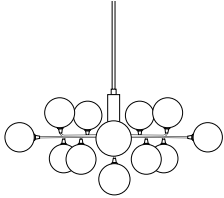

CLUSTER WHEEL

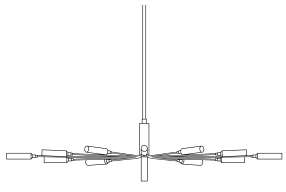
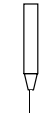
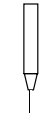
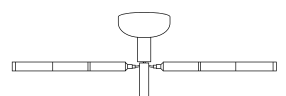
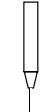
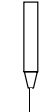
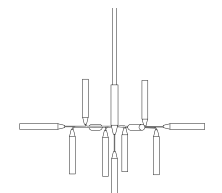

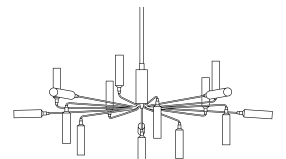
DESIGNS	TYPE	TECHN. LED BULB	DIMENSION	PARTS	PRICE
CLUSTER CROWN 	HL 9	12 V 1W LED 130LM 2700K G4	∅ 70 † 40 cm	 GBU-L	€ 955
	HL 13	12 V 1W LED 130LM 2700K G4	∅ 80 † 45 cm		€ 1340
	HL 16	12 V 1W LED 130LM 2700K G4	∅ 95 † 45 cm		€ 1660
	HL 33	12 V 1W LED 130LM 2700K G4	∅ 140 † 45 cm		€ 3500
	PL 9	12 V 1W LED 130LM 2700K G4	∅ 70 † 40 cm		€ 955
			6 mm - inox		
CLUSTER WHEEL 	HL 9	12 V 1W LED 130LM 2700K G4	∅ 70 † 25 cm	 GBU-L	€ 955
	HL 13	12 V 1W LED 130LM 2700K G4	∅ 80 † 30 cm		€ 1340
	HL 16	12 V 1W LED 130LM 2700K G4	∅ 95 † 30 cm		€ 1660
	PL 9	12 V 1W LED 130LM 2700K G4	∅ 70 † 30 cm		€ 955
	PL 13	12 V 1W LED 130LM 2700K G4	∅ 80 † 35 cm		€ 1340
PL 16	12 V 1W LED 130LM 2700K G4	∅ 95 † 35 cm	€ 1660		
			6 mm - inox		
CLUSTER CROWN OVAL 	HL 13	12 V 1W LED 130LM 2700K G4	∅ 120 x 50 cm † ** cm	 GBU-L	€ 1340
			6 mm - inox		

DESIGNS	TYPE	TECHN. LED BULB	DIMENSION	PARTS	PRICE
CROSSFIRE OVAL LARGE 	HL 13	12 V 1W LED 130LM 2700K G4	Ø 120 x 46 cm		€ 995
	HL 17	12 V 1W LED 130LM 2700K G4	Ø 150 x 51 cm		€ 1349
	PL 13	12 V 1W LED 130LM 2700K G4	Ø 120 x 46 cm		€ 995
	PL 17	12 V 1W LED 130LM 2700K G4	Ø 150 x 51 cm		€ 1349
			6 mm - inox	GCR-L	
CROSSFIRE WHEEL LARGE 	HL 13	12 V 1W LED 130LM 2700K G4	Ø 75 † 30 cm		€ 995
	HL 16	12 V 1W LED 130LM 2700K G4	Ø 95 † 30 cm		€ 1295
	PL 13	12 V 1W LED 130LM 2700K G4	Ø 75 † 30 cm		€ 995
	PL 16	12 V 1W LED 130LM 2700K G4	Ø 95 † 30 cm		€ 1295
			6 mm - inox	GCR-L	
CROSSFIRE / CROSSFIRE CABLE 	HL 6	12 V 1W LED 130LM 2700K G4	Ø 30 † ** cm		€ 399
	HL 13	12 V 1W LED 130LM 2700K G4	Ø 52 † ** cm		€ 799
	PL 6	12 V 1W LED 130LM 2700K G4	Ø 30 † 20 cm		€ 399
	PL 9	12 V 1W LED 130LM 2700K G4	Ø 52 † 35 cm		€ 599
			3 mm - inox	GCR	
CROSSFIRE LARGE 	HL 13	12 V 1W LED 130LM 2700K G4	Ø 75 † 45 cm		€ 995
	HL 16	12 V 1W LED 130LM 2700K G4	Ø 95 † 45 cm		€ 1295
	HL 33	12 V 1W LED 130LM 2700K G4	Ø 136 † 45 cm		€ 2840
	PL 9	12 V 1W LED 130LM 2700K G4	Ø 65 † 35 cm		€ 699
			6 mm - inox	GCR-L	



33

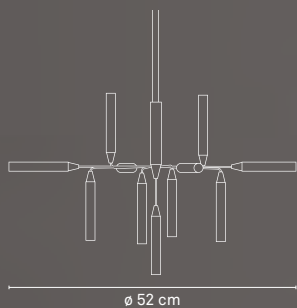

HL 13

CROSSFIRE



CROSSFIRE CABLE

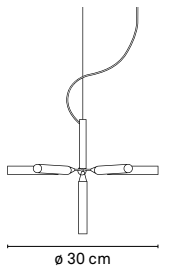





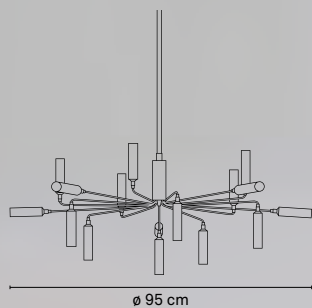

35



ø 95 cm

HL 16

CROSSFIRE LARGE

DESIGNS	TYPE	TECHN. LED BULB				DIMENSION		PARTS	PRICE	
<p>CRYSTAL</p>    	HL 9	12 V	1W LED	130LM	2700K	G4	∅ 80 ↓ ** cm		€ 790	
	HL 12	12 V	1W LED	130LM	2700K	G4	∅ 90 ↓ ** cm		€ 995	
	HL 14	12 V	1W LED	130LM	2700K	G4	∅ 110 ↓ ** cm		€ 1275	
	PL 9	12 V	1W LED	130LM	2700K	G4	∅ 80 ↓ 55 cm		€ 790	
	PL 12	12 V	1W LED	130LM	2700K	G4	∅ 90 ↓ 70 cm		€ 995	
	PL 14	12 V	1W LED	130LM	2700K	G4	∅ 110 ↓ 85 cm		€ 1275	
								4 mm - inox		
		WL/PL 1	12 V	1.5W LED	200LM	2700K	G4	∅ 20 → 20 cm		€ 159
		WL/PL 3	12 V	1.5W LED	200LM	2700K	G4	∅ 30 → 20 cm		€ 340
		WL/PL 5	12 V	1W LED	130LM	2700K	G4	∅ 40 → 25 cm		€ 475
								3 mm - inox	GCY multicol. transp. 2 3 4 5 7 10 15 18 22	

CRYSTAL COLORS – GCY/DTJ





37

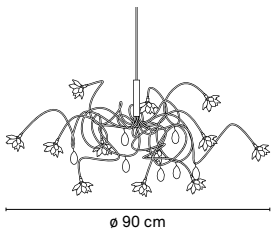





HL 12

CRYSTAL

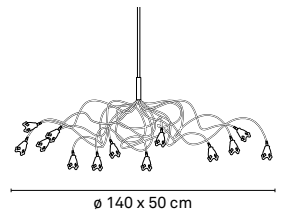

FLAG OVAL

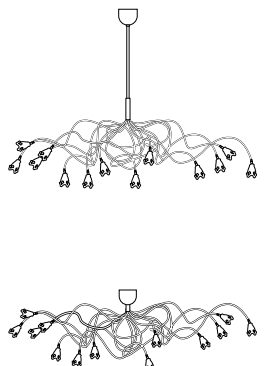

DESIGNS	TYPE	TECHN. LED BULB	DIMENSION	PARTS	PRICE	
<p>FLAG</p> 	HL 10	12 V 1W LED 130LM 2700K G4	Ø 90 ↓ ** cm	 GFL	€ 999	
	HL 14	12 V 1W LED 130LM 2700K G4	Ø 100 ↓ ** cm		€ 1299	
	HL 20	12 V 1W LED 130LM 2700K G4	Ø 170 ↓ ** cm		€ 1999	
	HL 24	12 V 1W LED 130LM 2700K G4	Ø 180 ↓ ** cm		€ 2399	
	HL 30	12 V 1W LED 130LM 2700K G4	Ø 200 ↓ ** cm		€ 2749	
	HL 35	12 V 1W LED 130LM 2700K G4	Ø 280 ↓ ** cm		€ 2995	
					6 mm - inox	
	PL 10	12 V 1W LED 130LM 2700K G4	Ø 90 ↓ 30 cm		€ 999	
	PL 14	12 V 1W LED 130LM 2700K G4	Ø 100 ↓ 40 cm		€ 1299	
	PL 20	12 V 1W LED 130LM 2700K G4	Ø 170 ↓ 50 cm		€ 1999	
	PL 24	12 V 1W LED 130LM 2700K G4	Ø 180 ↓ 50 cm		€ 2399	
	PL 30	12 V 1W LED 130LM 2700K G4	Ø 200 ↓ 50 cm		€ 2749	
	PL 35	12 V 1W LED 130LM 2700K G4	Ø 250 ↓ 50 cm		€ 2995	
					6 mm - inox	
<p>FLAG OVAL</p> 	HL 10	12 V 1W LED 130LM 2700K G4	Ø 110 x 50 cm	 GFL	€ 999	
	HL 14	12 V 1W LED 130LM 2700K G4	Ø 140 x 50 cm		€ 1299	
	HL 20	12 V 1W LED 130LM 2700K G4	Ø 170 x 60 cm		€ 1999	
	HL 24	12 V 1W LED 130LM 2700K G4	Ø 180 x 70 cm		€ 2399	
	HL 30	12 V 1W LED 130LM 2700K G4	Ø 200 x 70 cm		€ 2749	
	HL 35	12 V 1W LED 130LM 2700K G4	Ø 250 x 80 cm		€ 2995	
	PL 10	12 V 1W LED 130LM 2700K G4	Ø 110 x 50 cm		€ 999	
	PL 14	12 V 1W LED 130LM 2700K G4	Ø 145 x 65 cm		€ 1299	
	PL 20	12 V 1W LED 130LM 2700K G4	Ø 170 x 70 cm		€ 1999	
	PL 24	12 V 1W LED 130LM 2700K G4	Ø 180 x 70 cm		€ 2399	
	PL 30	12 V 1W LED 130LM 2700K G4	Ø 200 x 70 cm		€ 2749	
	PL 35	12 V 1W LED 130LM 2700K G4	Ø 250 x 80 cm		€ 2995	
					6 mm - inox	

HARCO LOOR DESIGN

40

HL 1

JELLY

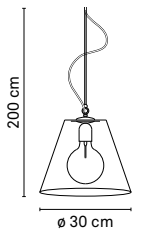



41

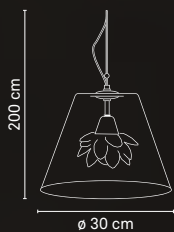

HL 1

FLOWER LARGE

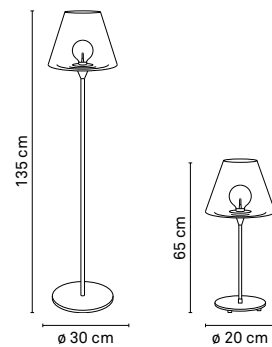

JELLY







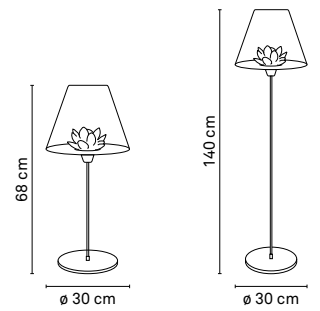

43



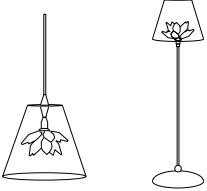

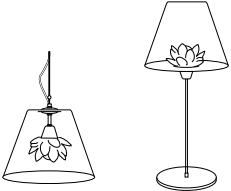

TL 1

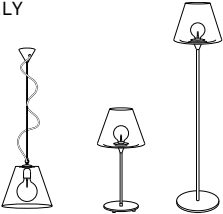
FLOWER

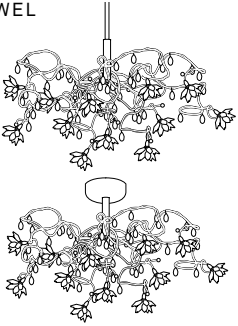

FLOWER LARGE

DESIGNS	TYPE	TECHN. LED BULB	DIMENSION	PARTS	PRICE
FLOWER 	HL 1	12 V 1.5W LED 130LM 2700K G4	Ø15 † var. st. 200 cm	 GCY 2 3 4 5 7 10 15 18 22	€ 325
	TL 1	12 V 1.5W LED 130LM 2700K G4	Ø 15 † 57 cm		€ 350
	FL 1	12 V 1.5W LED 130LM 2700K G4	Ø 15 † 127 cm		inox
FLOWER LARGE 	HL 1	12 V 1.5W LED 130LM 2700K G4	Ø30 † var. st. 200 cm	 GBF 2 5 15 18 22	€ 495
	TL 1	12 V 1.5W LED 130LM 2700K G4	Ø 30 † 68 cm		€ 550
	FL 1	12 V 1.5W LED 130LM 2700K G4	Ø 30 † 140 cm		inox
HOOD 	TL 1	12 V 1.5W LED 130LM 2700K G4	Ø 11 † 52 cm	 GHO	€ 199
	FL 1	12 V 1.5W LED 130LM 2700K G4	Ø 11 † 140 cm		3 mm - inox
JELLY 	HL 1	12 V 1.5W LED 130LM 2700K G4	Ø30 † var. st. 200 cm	inox	€ 385
	TL 1	12 V 1.5W LED 130LM 2700K G4	Ø 30 † 65 cm		€ 495
	FL 1	12 V 1.5W LED 130LM 2700K G4	Ø 30 † 135 cm		€ 595

DESIGNS	TYPE	TECHN. LED BULB	DIMENSION	PARTS	PRICE	
<p>JEWEL</p> 	HL 9	12 V 1W LED 130LM 2700K G4	∅ 50 † ** cm	 GCY/DTJ multicol. transp. 2 3 4 5 7 10 15 18 22	€ 1195	
	HL 12	12 V 1W LED 130LM 2700K G4	∅ 60 † ** cm		€ 1590	
	HL 15	12 V 1W LED 130LM 2700K G4	∅ 80 † ** cm		€ 1950	
	HL 24	12 V 1W LED 130LM 2700K G4	∅ 120 † ** cm		€ 3625	
	PL 9	12 V 1W LED 130LM 2700K G4	∅ 50 † 30 cm		€ 1195	
	PL 12	12 V 1W LED 130LM 2700K G4	∅ 60 † 30 cm		€ 1590	
	PL 15	12 V 1W LED 130LM 2700K G4	∅ 80 † 35 cm		€ 1950	
	PL 24	12 V 1W LED 130LM 2700K G4	∅ 120 † 35 cm		€ 3625	
					2 x 3 mm - inox	
	<p>JEWEL</p> 	TL 1	12 V 1.5W LED 130LM 2700K G4		† 50 cm	 GCY/DTJ multicol. transp. 2 3 4 5 7 10 14 15 18 22
TL 3		12 V 1.5W LED 130LM 2700K G4	† 60 cm	€ 445		
<p>JEWEL LONG</p> 	WL 5	12 V 1W LED 130LM 2700K G4	† 70 ↔ 30 cm ↔ 20 cm	 GCY/DTJ multicol. transp. 2 3 4 5 7 10 15 18 22	€ 695	
	WL 9	12 V 1W LED 130LM 2700K G4	† 110 ↔ 35 cm ↔ 20 cm		€ 1295	
			2 x 3 mm - inox			

46

JEWEL COLORS – GCY/DTJ



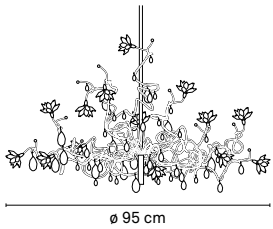

JEWEL CHANDELIER

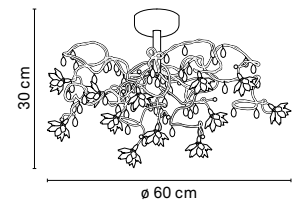
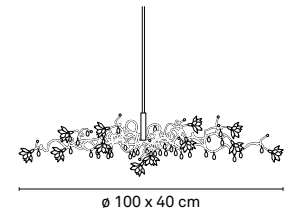

JEWEL OVAL - JEWEL



49

WL 5



70 cm

30 cm

JEWEL LONG

HARCO LOOR DESIGN





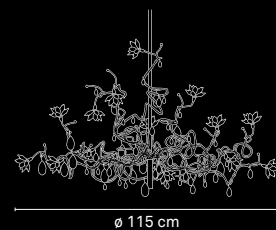

50

HL24









JEWEL CHANDELIER

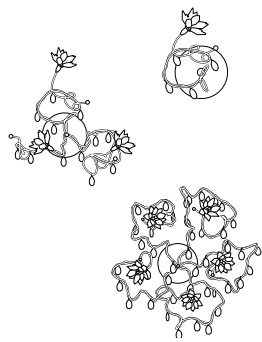

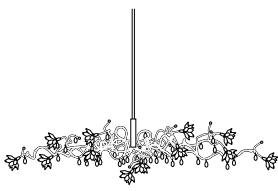
DESIGNS	TYPE	TECHN. LED BULB	DIMENSION	PARTS	PRICE
JEWEL CHANDELIER 	HL 12	12 V 1W LED 130LM 2700K G4	∅ 75 ↓ ** cm	  GCY/DTJ multicol. transp. 2 3 4 5 7 10 15 18 22	€ 1590
	HL 15	12 V 1W LED 130LM 2700K G4	∅ 95 ↓ ** cm		€ 1950
	HL 24	12 V 1W LED 130LM 2700K G4	∅ 115 ↓ ** cm		€ 3625
JEWEL CHANDELIER OVAL 	HL 12	12 V 1W LED 130LM 2700K G4	∅ 125 x 40 cm	  GCY/DTJ multicol. transp. 2 3 4 5 7 10 15 18 22	€ 1590
	HL 15	12 V 1W LED 130LM 2700K G4	∅ 135 x 55 cm		€ 1950
	HL 24	12 V 1W LED 130LM 2700K G4	∅ 145 x 65 cm		€ 3625
			2 x 3 mm - inox		

JEWEL COLORS – GCY/DTJ

DESIGNS	TYPE	TECHN. LED BULB	DIMENSION	PARTS	PRICE
JEWEL 	WL/PL 1 WL/PL 3 WL/PL 5	12 V 1.5W LED 200LM 2700K G4 12 V 1.5W LED 200LM 2700K G4 12 V 1W LED 130LM 2700K G4	Ø 20 → 15 cm Ø 30 → 15 cm Ø 45 → 20 cm 2 x 3 mm - inox	 GCY/DTJ multicol. transp. 2 3 4 5 7 10 15 18 22	€ 199 € 399 € 625
JEWEL OVAL 	HL 9 HL 12 HL 15 HL 24	12 V 1W LED 130LM 2700K G4 12 V 1W LED 130LM 2700K G4 12 V 1W LED 130LM 2700K G4 12 V 1W LED 130LM 2700K G4	Ø 90 x 35 cm Ø 100 x 40 cm Ø 120 x 45 cm Ø 145 x 45 cm 2 x 3 mm - inox	 GCY/DTJ multicol. transp. 2 3 4 5 7 10 15 18 22	€ 1275 € 1650 € 2150 € 3800
JEWEL KITE 	HL 12 HL 18 HL 30	12 V 1W LED 130LM 2700K G4 12 V 1W LED 130LM 2700K G4 12 V 1W LED 130LM 2700K G4	↔ 110 x 30 cm ↔ 140 x 40 cm ↔ 180 x 40 cm ‡ var. st. 200 cm 2 x 3 mm - inox	 GCY/DTJ multicol. transp. 2 3 4 5 7 10 15 18 22	€ 1799 € 2500 € 4290

52

JEWEL COLORS – GCY/DTJ









JEWEL KITE

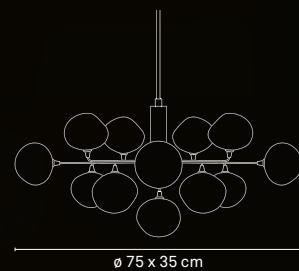



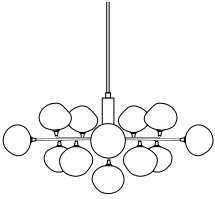

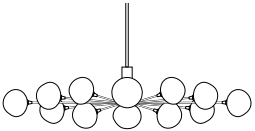

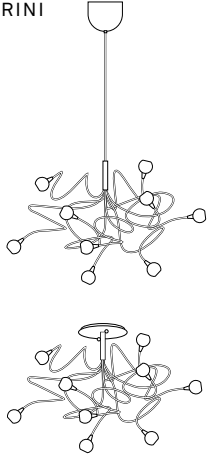

METEOR LARGE

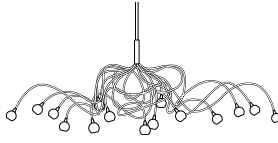

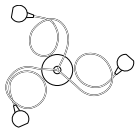
ø 75 x 35 cm

DESIGNS	TYPE	TECHN. LED BULB	DIMENSION	PARTS	PRICE
<p>METEOR LARGE</p> 	HL 9	12 V 1W LED 130LM 2700K G4	∅ 65 ± 30 cm	 GME	€ 995
	HL 13	12 V 1W LED 130LM 2700K G4	∅ 75 ± 35 cm ↓ ** cm		€ 1395
	PL 9	12 V 1W LED 130LM 2700K G4	∅ 65 ± 35 cm 6 mm - inox		€ 995
<p>METEOR LARGE OVAL</p> 	HL 13	12 V 1W LED 130LM 2700K G4	∅ 115 x 45 cm ± 25 cm ↓ ** cm 6 mm - inox	 GME	€ 1395

DESIGNS	TYPE	TECHN. LED BULB	DIMENSION	PARTS	PRICE	
MURRINI 	HL 7	12 V 1W LED 130LM 2700K G4	∅ 70 ↓ ** cm	 GMU	€ 650	
	HL 9	12 V 1W LED 130LM 2700K G4	∅ 80 ↓ ** cm		€ 795	
	HL 12	12 V 1W LED 130LM 2700K G4	∅ 90 ↓ ** cm		€ 960	
	HL 15	12 V 1W LED 130LM 2700K G4	∅ 120 ↓ ** cm		€ 1325	
	HL 20	12 V 1W LED 130LM 2700K G4	∅ 140 ↓ ** cm		€ 1935	
	PL 7	12 V 1W LED 130LM 2700K G4	∅ 60 ↓ 30 cm		€ 650	
	PL 9	12 V 1W LED 130LM 2700K G4	∅ 60 ↓ 30 cm		€ 795	
	PL 12	12 V 1W LED 130LM 2700K G4	∅ 80 ↓ 30 cm		€ 960	
	PL 15	12 V 1W LED 130LM 2700K G4	∅ 120 ↓ 40 cm		€ 1325	
	PL 20	12 V 1W LED 130LM 2700K G4	∅ 140 ↓ 40 cm		€ 1935	
					3 mm - inox	
	MURRINI OVAL 	HL 12	12 V 1W LED 130LM 2700K G4		∅ 120 x 50 cm	 GMU
HL 15		12 V 1W LED 130LM 2700K G4	∅ 130 x 60 cm	€ 1325		
HL 20		12 V 1W LED 130LM 2700K G4	∅ 140 x 70 cm	€ 1935		
			↓ ** cm			
			3 mm - inox			
MURRINI 	WL/PL 1	12 V 1.5W LED 200LM 2700K G4	∅ 20 ↗ 20 cm	 GMU	€ 149	
	WL/PL 3	12 V 1.5W LED 200LM 2700K G4	∅ 30 ↗ 20 cm		€ 315	
	WL/PL 5	12 V 1W LED 130LM 2700K G4	∅ 30 ↗ 25 cm		€ 485	
					3 mm - inox	
MURRINI 	TL 1	12 V 1.5W LED 200LM 2700K G4	↓ 50 cm	 GMU	€ 175	
	TL 2	12 V 1.5W LED 200LM 2700K G4	↓ 50 cm		€ 250	
	TL 3	12 V 1.5W LED 200LM 2700K G4	↓ 50 cm		€ 325	
	TL 5	12 V 1W LED 130LM 2700K G4	↓ 70 cm		€ 495	
	FL 7	12 V 1W LED 130LM 2700K G4	↓ 160 cm		€ 750	
	FL 9	12 V 1W LED 130LM 2700K G4	↓ 170 cm		€ 925	
					3 mm - inox	



57

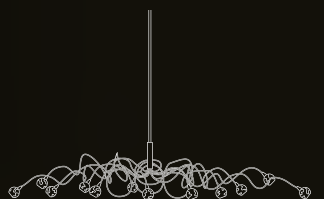







ø 120 x 50 cm

MURRINI OVAL

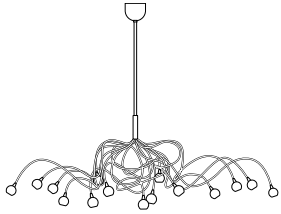

SNOWBALL OVAL

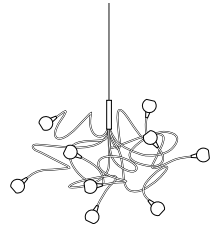
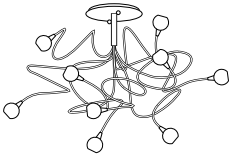

DESIGNS	TYPE	TECHN. LED BULB	DIMENSION	PARTS	PRICE	
PENNE 	TL 3	12 V 1.5W LED 130LM 2700K G4	‡ 70 cm	 GPE	€ 399	
	TL 5	12 V 1W LED 130LM 2700K G4	‡ 80 cm		€ 549	
	FL 5	12 V 1W LED 130LM 2700K G4	‡ 185 cm		€ 599	
	FL 7	12 V 1W LED 130LM 2700K G4	‡ 195 cm		€ 750	
					6 mm - inox	
SNOWBALL OVAL 	HL 12	12 V 1W LED 130LM 2700K G4	∅ 120 x 50 cm	 GSN	€ 779	
	HL 15	12 V 1W LED 130LM 2700K G4	∅ 130 x 60 cm		€ 1095	
	HL 20	12 V 1W LED 130LM 2700K G4	∅ 140 x 70 cm		€ 1595	
SNOWBALL  	HL 7	12 V 1W LED 130LM 2700K G4	∅ 70 ‡ ** cm	 GSN	€ 499	
	HL 9	12 V 1W LED 130LM 2700K G4	∅ 80 ‡ ** cm		€ 599	
	HL 12	12 V 1W LED 130LM 2700K G4	∅ 90 ‡ ** cm		€ 779	
	HL 15	12 V 1W LED 130LM 2700K G4	∅ 120 ‡ ** cm		€ 1095	
	HL 20	12 V 1W LED 130LM 2700K G4	∅ 140 ‡ ** cm		€ 1595	
	PL 7	12 V 1W LED 130LM 2700K G4	∅ 60 ‡ 30 cm		€ 499	
	PL 9	12 V 1W LED 130LM 2700K G4	∅ 60 ‡ 30 cm		€ 599	
	PL 12	12 V 1W LED 130LM 2700K G4	∅ 80 ‡ 30 cm		€ 779	
	PL 15	12 V 1W LED 130LM 2700K G4	∅ 120 ‡ 40 cm		€ 1095	
	PL 20	12 V 1W LED 130LM 2700K G4	∅ 140 ‡ 40 cm		€ 1595	
					6 mm - inox	
					3 mm - inox	

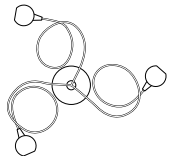

ø 30 cm

SNOWBALL



61

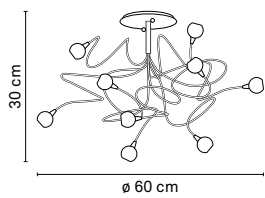

PL 9

SNOWBALL





HARCO LOOR DESIGN

62

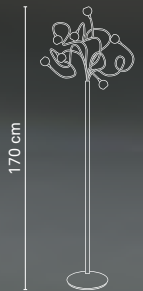
FL 9

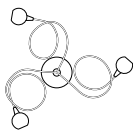

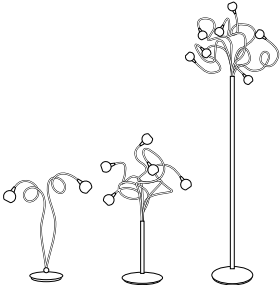

SNOWBALL

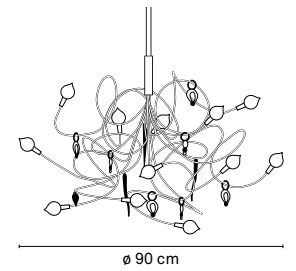



DESIGNS	TYPE	TECHN. LED BULB	DIMENSION	PARTS	PRICE
SNOWBALL 	WL/PL 1	12 V 1.5W LED 200LM 2700K G4	∅ 20 ⇄ 20 cm	 GSN	€ 130
	WL/PL 3	12 V 1.5W LED 200LM 2700K G4	∅ 30 ⇄ 20 cm		€ 270
	WL/PL 5	12 V 1W LED 130LM 2700K G4	∅ 30 ⇄ 25 cm		€ 395
3 mm - inox					
SNOWBALL 	TL 1	12 V 1.5W LED 200LM 2700K G4	‡ 50 cm	 GSN	€ 149
	TL 2	12 V 1.5W LED 200LM 2700K G4	‡ 50 cm		€ 225
	TL 3	12 V 1.5W LED 200LM 2700K G4	‡ 50 cm		€ 290
	TL 5	12 V 1W LED 130LM 2700K G4	‡ 70 cm		€ 449
	FL 7	12 V 1W LED 130LM 2700K G4	‡ 160 cm		€ 650
	FL 9	12 V 1W LED 130LM 2700K G4	‡ 170 cm		€ 790
					3 mm - inox

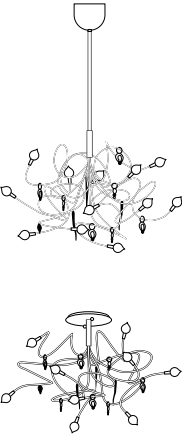

STRAWBERRY

DESIGNS	TYPE	TECHN. LED BULB	DIMENSION	PARTS	PRICE
STRAWBERRY OVAL 	HL 12 HL 15 HL 20	12 V 1W LED 130LM 2700K G4 12 V 1W LED 130LM 2700K G4 12 V 1W LED 130LM 2700K G4	Ø 120 x 50 cm Ø 130 x 60 cm Ø 140 x 70 cm	 GSW multicol. 2 4 5 7 8 9 10 15	€ 995 € 1369 € 1900
STRAWBERRY 	WL/PL 1 WL/PL 3 WL/PL 5	12 V 1.5W LED 200LM 2700K G4 12 V 1.5W LED 200LM 2700K G4 12 V 1W LED 130LM 2700K G4	Ø 20 ↔ 20 cm Ø 30 ↔ 20 cm Ø 40 ↔ 25 cm	 GSW multicol. 2 4 5 7 8 9 10 15	€ 149 € 299 € 425
STRAWBERRY 	HL 7 HL 9 HL 12 HL 15 HL 20 PL 7 PL 9 PL 12 PL 15 PL 20	12 V 1W LED 130LM 2700K G4 12 V 1W LED 130LM 2700K G4 12 V 1W LED 130LM 2700K G4 12 V 1W LED 130LM 2700K G4 12 V 1W LED 130LM 2700K G4 12 V 1W LED 130LM 2700K G4 12 V 1W LED 130LM 2700K G4 12 V 1W LED 130LM 2700K G4 12 V 1W LED 130LM 2700K G4 12 V 1W LED 130LM 2700K G4	Ø 70 † ** cm Ø 80 † ** cm Ø 90 † ** cm Ø 120 † ** cm Ø 140 † ** cm Ø 50 † 30 cm Ø 60 † 30 cm Ø 80 † 30 cm Ø 120 † 40 cm Ø 140 † 40 cm	 GSW multicol. 2 4 5 7 8 9 10 15	€ 599 € 700 € 995 € 1369 € 1900 € 599 € 700 € 995 € 1369 € 1900

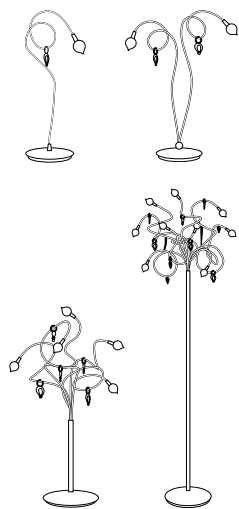
STRAWBERRY COLORS – GSW

DESIGNS	TYPE	TECHN. LED BULB	DIMENSION	PARTS	PRICE	
<p>STRAWBERRY</p> 	TL 1	12 V 1.5W LED 200LM 2700K G4	‡ 50 cm		€ 195	
	TL 2	12 V 1.5W LED 200LM 2700K G4	‡ 50 cm		€ 250	
	TL 3	12 V 1.5W LED 200LM 2700K G4	‡ 50 cm		€ 350	
	TL 5	12 V 1W LED 130LM 2700K G4	‡ 70 cm		€ 490	
	FL 7	12 V 1.5W LED 200LM 2700K G4	‡ 160 cm	 GSW multicol. 2 4 5 7 8 9 10 15	€ 795	
	FL 9	12 V 1W LED 130LM 2700K G4	‡ 170 cm		€ 960	
				3 mm - inox		

STRAWBERRY COLORS – GSW



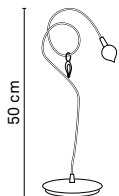

STRAWBERRY

HARCO LOOR DESIGN









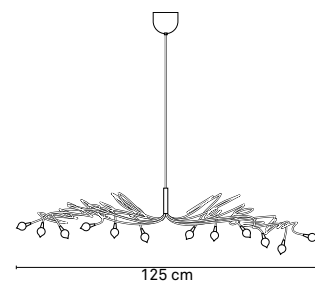

68

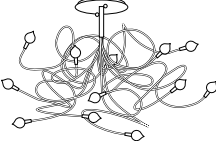

HL9

SWEET LONG







DESIGNS	TYPE	TECHN. LED BULB	DIMENSION	PARTS	PRICE
<p>SWEET</p>   	HL 7	12 V 1W LED 130LM 2700K G4	∅ 70 ↓ ** cm	 <p>GWS multicol. 2 4 5 7 8 9 10 15</p>	€ 529
	HL 9	12 V 1W LED 130LM 2700K G4	∅ 80 ↓ ** cm		€ 669
	HL 12	12 V 1W LED 130LM 2700K G4	∅ 90 ↓ ** cm		€ 899
	HL 15	12 V 1W LED 130LM 2700K G4	∅ 120 ↓ ** cm		€ 1149
	HL 20	12 V 1W LED 130LM 2700K G4	∅ 140 ↓ ** cm		€ 1699
	PL 7	12 V 1W LED 130LM 2700K G4	∅ 60 ↓ 30 cm		€ 529
	PL 9	12 V 1W LED 130LM 2700K G4	∅ 70 ↓ 30 cm		€ 669
	PL 12	12 V 1W LED 130LM 2700K G4	∅ 80 ↓ 30 cm		€ 899
	PL 15	12 V 1W LED 130LM 2700K G4	∅ 120 ↓ 40 cm		€ 1149
	PL 20	12 V 1W LED 130LM 2700K G4	∅ 140 ↓ 40 cm		€ 1699
<p>SWEET OVAL</p>  	HL 12	12 V 1W LED 130LM 2700K G4	∅ 120 x 50 cm	 <p>GWS multicol. 2 4 5 7 8 9 10 15</p>	€ 899
	HL 15	12 V 1W LED 130LM 2700K G4	∅ 130 x 60 cm		€ 1149
	HL 20	12 V 1W LED 130LM 2700K G4	∅ 140 x 70 cm		€ 1699
			↓ ** cm		
<p>SWEET LONG</p>  	HL 12	12 V 1W LED 130LM 2700K G4	↔ 125 ↓ ** cm	 <p>GWS multicol. 2 4 5 7 8 9 10 15</p>	€ 899
	HL 15	12 V 1W LED 130LM 2700K G4	↔ 140 ↓ ** cm		€ 1149
			3 mm - inox		

69

SWEET COLORS – GSW

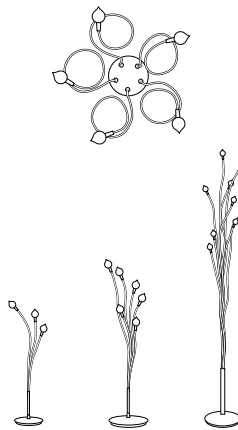

DESIGNS	TYPE	TECHN. LED BULB	DIMENSION	PARTS	PRICE
SWEET LONG 	WL 5	12 V 1W LED 200LM 2700K G4	‡ 50 ↔ 30 cm	 GSW multicol. 2 4 5 7 8 9 10 15	€ 426
	WL 7	12 V 1W LED 200LM 2700K G4	‡ 70 ↔ 35 cm		€ 569
	WL 9	12 V 1W LED 200LM 2700K G4	‡ 120 ↔ 40 cm		€ 727
	WL 12	12 V 1W LED 130LM 2700K G4	‡ 120 ↔ 40 cm		€ 940
			↔ 25 cm		
			3 mm - inox		
SWEET 	WL/PL 1	12 V 1.5W LED 200LM 2700K G4	∅ 20 ↔ 20 cm	 GSW multicol. 2 4 5 7 8 9 10 15	€ 137
	WL/PL 3	12 V 1.5W LED 200LM 2700K G4	∅ 30 ↔ 20 cm		€ 275
	WL/PL 5	12 V 1W LED 130LM 2700K G4	∅ 40 ↔ 25 cm		€ 417
	TL 3	12 V 1.5W LED 200LM 2700K G4	‡ 60 cm		€ 299
	TL 6	12 V 1W LED 200LM 2700K G4	‡ 80 cm		€ 479
	FL 9	12 V 1W LED 200LM 2700K G4	‡ 175 cm		€ 849
			3 mm - inox		

70

SWEET COLORS – GSW

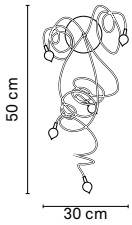
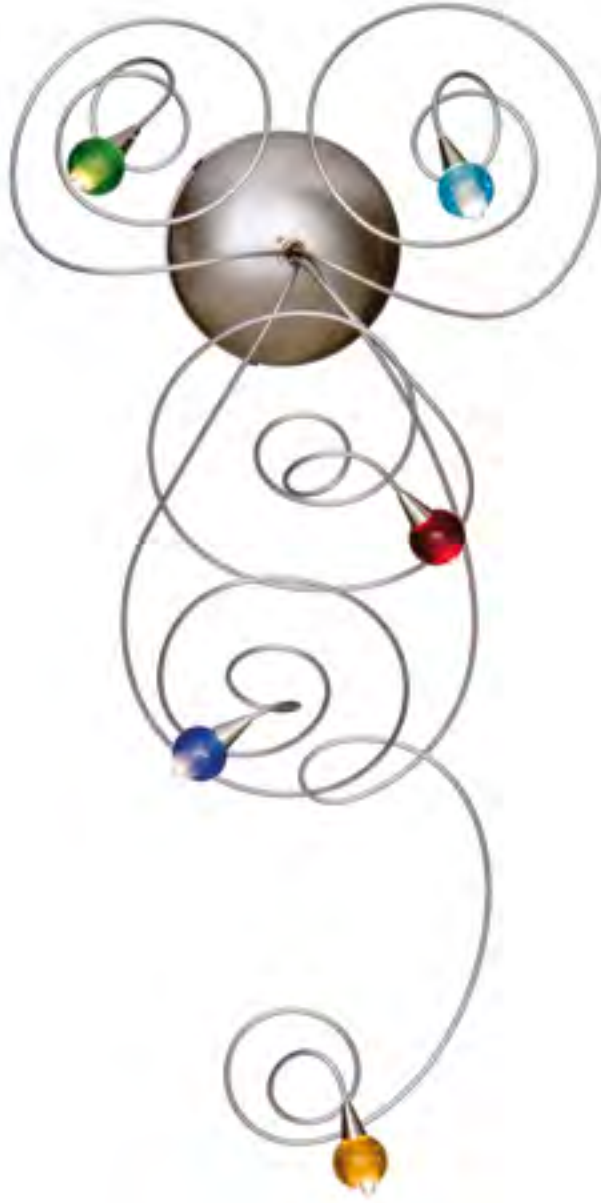
TARGET



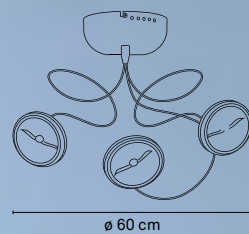

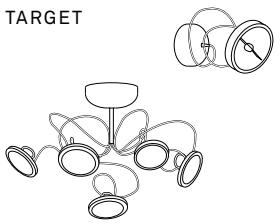

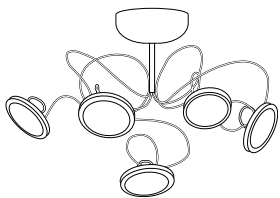

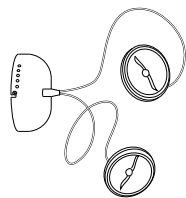
DESIGNS	TYPE	TECHN. LED BULB	DIMENSION	PARTS	PRICE
TARGET 	WL/PL 1	12 V 10W 675LM 2700K QR111	∅ 15 cm		€ 225
	WL/PL 2	12 V 10W 675LM 2700K QR111	∅ 40 cm		€ 350
	WL/PL 3	12 V 10W 675LM 2700K QR111	∅ 60 cm		€ 480
	WL/PL 5	12 V 10W 675LM 2700K QR111	∅ 65 cm		€ 795
			3 mm - inox		

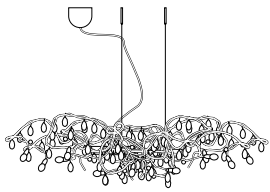

∅ 65 cm

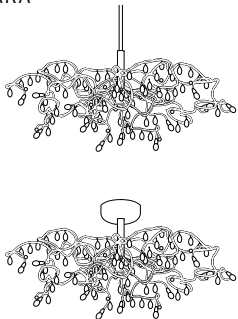

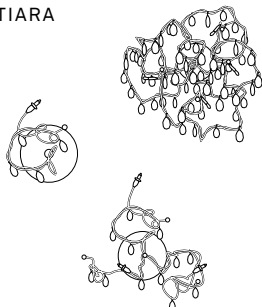
∅ 40 cm

DESIGNS	TYPE	TECHN. LED BULB	DIMENSION	PARTS	PRICE
TIARA KITE 	HL 12 HL 18 HL 30	12 V 1W LED 130LM 2700K G4 12 V 1W LED 130LM 2700K G4 12 V 1W LED 130LM 2700K G4	↔ 110 x 30 cm ↔ 140 x 40 cm ↔ 180 x 40 cm ‡ var. st. 200 cm 2 x 3 mm - inox	 DTJ multicol. transp. 2 3 4 5 7 8 9 10 14 15 18 22 23	€ 1495 € 1995 € 3650
TIARA 	HL 9 HL 12 HL 15 HL 24 PL 9 PL 12 PL 15 PL 24	12 V 1W LED 130LM 2700K G4 12 V 1W LED 130LM 2700K G4 12 V 1W LED 130LM 2700K G4 12 V 1W LED 130LM 2700K G4 12 V 1W LED 130LM 2700K G4 12 V 1W LED 130LM 2700K G4 12 V 1W LED 130LM 2700K G4 12 V 1W LED 130LM 2700K G4	Ø 50 † ** cm Ø 60 † ** cm Ø 70 † ** cm Ø 120 † ** cm Ø 50 † 20 cm Ø 60 † 25 cm Ø 70 † 35 cm Ø 120 † 35 cm 2 x 3 mm - inox	 DTJ multicol. transp. 2 3 4 5 7 8 9 10 14 15 18 22 23	€ 995 € 1250 € 1600 € 2850 € 995 € 1250 € 1600 € 2850
TIARA 	WL/PL 1 WL/PL 3 WL/PL 5	12 V 1.5W LED 200LM 2700K G4 12 V 1.5W LED 200LM 2700K G4 12 V 1W LED 130LM 2700K G4	Ø 20 ↔ 20 cm Ø 30 ↔ 25 cm Ø 45 ↔ 25 cm 2 x 3 mm - inox	 DTJ multicol. transp. 2 3 4 5 7 8 9 10 14 15 18 22 23	€ 180 € 370 € 499

74

TIARA COLORS – DTJ

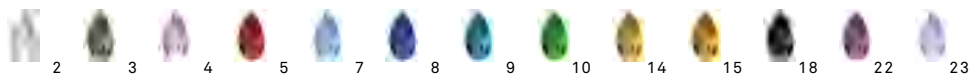



75

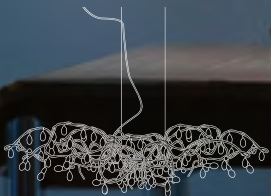

110 x 30 cm

HL 12

TIARA KITE



TIARA

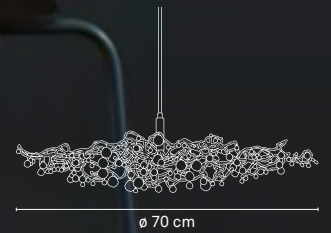



77

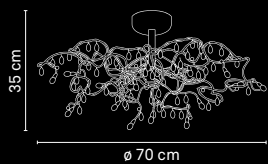

35 cm

ø 70 cm

PL 15

TIARA





HARCO LOOR DESIGN

78

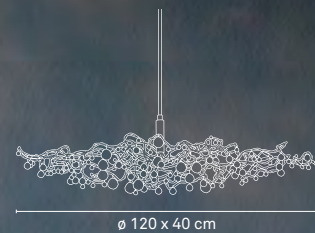
HL 15

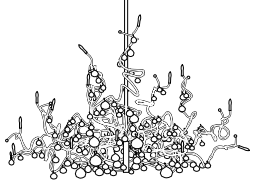



TIARA OVAL

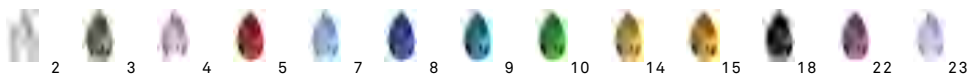

DESIGNS	TYPE	TECHN. LED BULB	DIMENSION	PARTS	PRICE
TIARA CHANDELIER 	HL 12	12 V 1W LED 130LM 2700K G4	∅ 75 ↓ ** cm	 DTJ multicol. transp. 2 3 4 5 7 8 9 10 14 15 18 22 23	€ 1395
	HL 15	12 V 1W LED 130LM 2700K G4	∅ 95 ↓ ** cm		€ 1650
	HL 24	12 V 1W LED 130LM 2700K G4	∅ 125 ↓ ** cm		€ 2949
					2 x 3 mm - inox
TIARA OVAL 	HL 9	12 V 1W LED 130LM 2700K G4	∅ 80 x 35 cm	 DTJ multicol. transp. 2 3 4 5 7 8 9 10 14 15 18 22 23	€ 1200
	HL 12	12 V 1W LED 130LM 2700K G4	∅ 90 x 35 cm		€ 1400
	HL 15	12 V 1W LED 130LM 2700K G4	∅ 120 x 40 cm		€ 1750
	HL 24	12 V 1W LED 130LM 2700K G4	∅ 145 x 45 cm		€ 2990
			2 x 3 mm - inox		

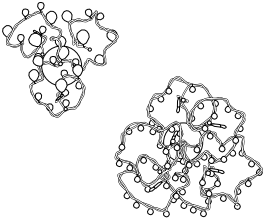
TIARA COLORS – DTJ



DESIGNS	TYPE	TECHN. LED BULB	DIMENSION	PARTS	PRICE
TIARA 	WL/PL 1 WL/PL 3 WL/PL 5	12 V 1.5W LED 200LM 2700K G4 12 V 1.5W LED 200LM 2700K G4 12 V 1W LED 130LM 2700K G4	Ø 20 ↔ 20 cm Ø 30 ↔ 25 cm Ø 45 ↔ 25 cm 2 x 3 mm - inox	 DTJ multicol. transp. 2 3 4 5 7 8 9 10 14 15 18 22 23	€ 195 € 395 € 595
TIARA LONG 	WL 5 WL 9	12 V 1W LED 130LM 2700K G4 12 V 1W LED 130LM 2700K G4	† 70 ↔ 35 cm † 110 ↔ 35 cm 2 x 3 mm - inox	 DTJ multicol. transp. 2 3 4 5 7 8 9 10 14 15 18 22 23	€ 595 € 995

TIARA COLORS – DTJ

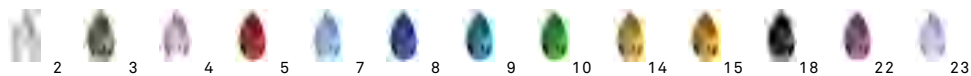







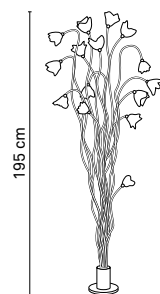

TIARA LONG

TREE BREEZE



DESIGNS	TYPE	TECHN. LED BULB	DIMENSION	PARTS	PRICE
<p>TREE BREEZE</p> 	<p>FL 10 FL 15</p>	<p>12 V 1W LED 130LM 2700K G4 12 V 1W LED 130LM 2700K G4</p>	<p>‡ 175 cm ‡ 195 cm</p> <p>6 mm - inox</p>	 <p>TRM</p>	<p>€ 1295 € 1595</p>
<p>TREE FLAG</p> 	<p>FL 10 FL 15</p>	<p>12 V 1W LED 130LM 2700K G4 12 V 1W LED 130LM 2700K G4</p>	<p>‡ 175 cm ‡ 195 cm</p> <p>6 mm - inox</p>	 <p>GFL</p>	<p>€ 1395 € 1695</p>
<p>WING</p> 	<p>FL 7</p>	<p>12 V 1W LED 130LM 2700K G4</p>	<p>‡ 180 cm</p> <p>6 mm - inox</p>	 <p>GWI</p>	<p>€ 795</p>

TOELICHTING / EXPLANATION / ERKLÄRUNG / EXPLICATION

HL Hanglamp / Hanging lamp / Pendelleuchte / Suspension
 PL Plafondlamp / Ceiling lamp / Deckenleuchte / Plafonnier
 TL Tafellamp / Table lamp / Tischleuchte / Lampe à poser
 FL Vloerlamp / Floor lamp / Stehleuchte / Lampadaire
 WL Wandlamp / Wall lamp / Wandleuchte / Applique
 ☼ Gaaskapje / Shade of mesh / Netzschirm / Résille inox
 🗋 Geperforeerde kap / Perforated shade / Perforierter Schirm / Abat-jour perforé

∅ Max. doorsnede / Max. diameter / Max. Durchmesser / Max. diamètre
 ⚓ Hoogte Corpus / Corpus Height / Korpus-Höhe / Hauteur du corps
 ↔ Breedte / Width / Breite / Largeur
 → Afstand van muur/plafond / Distance from wall/ceiling / Distanz vom Wand/Decke / Distance de mur/plafond
 ↓ (Maximum) hoogte / (Maximum) height / (Maximal-) Höhe / Hauteur (maximum)

↑**CM St. totale hoogte met pendel HL = 110cm, andere hoogte bij bestelling opgeven.

↑**CM St. total height with rod HL = 110cm, other desired heights to be stated by ordering.

↑**CM St. Gesamtlänge mit Rohr HL=110cm, andere Höhe beim Auftrag angeben.

↑**CM Hauteur st. avec tige HL = 110cm, autre indiquer à commande.

⚓ var. st. 200 cm kabel wordt meegeleverd / var. st. 200 cable is included / var. st. 200 cm Kabel inbegripen / var. st. 200 cm câble est inclus.

HALO. Lamp in halogeen uitvoering, dimbaar/Halogen version, dimmable/Halogenausführung, Dimbar/Version halogène, dimmable

LED Lamp in LED uitvoering / LED version / LED Ausführung / Version LED

84

LED SPECIFICATION







Voltage	12V/AC/DC	Intensity	130 Lumen
Power	1 WATT	Color temperature	2700K (warm white)
Fitting	G4 LED	D10*31mm	
Dimmer	PWM	Pulse Width Modulation	1 tot 25 WATT VA







COLORS / KLEUREN / FARBEN / COULEURS







1 Wit / White / Weiss / Blanc	10 Groen / Green / Grün / Vert
2 Transparant / Transparent / Transparent / Transparent	14 Geel / Yellow / Gelb / Jaune
3 Rook / Smoke / Rauch / Fumée	15 Amber / Amber / Amber / Ambre
4 Roze / Pink / Rosa / Rose	18 Zwart / Black / Schwarz / Noir
5 Rood / Red / Rot / Rouge	22 Amethyst / Amethyst / Amethyst/ AméthysteDoré
7 Lichtblauw / Light blue / Hellblau / Bleu clair	23 Lila /Lilac / Lila /Lilas
8 Donkerblauw / Dark blue / Dunkelblau / Blue foncé	
9 Turquoise / Turquoise / Tuerkis / Turquoise	

EXPLANATION

ONDERDELEN / SPARE PARTS / ERSATZTEILE / ACCESSOIRES

HOOD (Ø 11)	PENNE	BALLOON (Ø 50)	FLAG	GUIRLANDE	WING	MURRINI
 € 35	 € 20	 € 20	 € 40	 € 30	 € 30	 € 40
GHO	GPE	GBA	GFL	GGU	GWI	GMU





SNOWBALL	METEOR	CRYSTAL JEWEL	SWEET STRAWBERRY	FLOWER-L	TREE BREEZE
 € 20	 € 50	 € 40	 € 25	 € 60	 € 26
GSN	GME	GCY	GSW	GBF	TRM
		2 3 4 5 7 10 15 18 22	2 4 5 7 8 9 10 15	2 4 5 7 15 18 22	2 5 15 18 22

BREEZE	CROSSFIRE	BUBBLES
 € 21	 € 20	 € 20
	 € 20	 € 25
		 € 30
		 € 35
BRM	GCR-L	GCR
		GBU-2 XS=Ø 6CM S=Ø 8CM M=Ø 10CM L=Ø12CM

85

ONDERDELEN / SPARE PARTS / ERSATZTEILE / ACCESSOIRES

DECORATIONS

<p>Electr. Dimmer for TL / FL </p> <p>60 VA € 40 150 VA € 60</p>	<p>Electr. Transformer for HL / WL / PL </p> <p>150 VA € 60 210 VA € 70 300 VA € 80</p>	<p>Electr. Transformer LED</p> <p>50 VA € 40 70 VA € 45 105 VA € 50</p>	<p>Gewricht / Ball joint / Kugelgelenk / Joint à rotule </p> <p>Ø 10 mm € 20 Ø 13 mm € 40</p>	<p>Deco Strawberry € 25</p> <p>Deco Tiara/Jewel  36 mm € 3 63 mm € 5</p>
<p>Electr. Dimmer LED for TL / FL</p> <p>1 tot 25W VA € 60</p>				

ARTIKEL 1 - TOEPASSELIJKHEID

- 1.1 Alle aanbiedingen, leveringen, diensten en verkopen zijn onderhevig aan deze verkoopvoorwaarden.

ARTIKEL 2 - AANBIEDINGEN/PRIJS

- 2.1 Alle aanbiedingen zijn vrijblijvend.
- 2.2 De opgegeven prijzen zijn gebaseerd op franco levering binnen Nederland en levering af fabriek buiten Nederland.
- 2.3 Indien na de datum van aanbieding één of meer der kostprijsfactoren een verhoging ondergaan - ook al geschiedt dit ingevolge voorzienbare omstandigheden - is Harco Loor gerechtigd de overeengekomen prijs dienovereenkomstig te verhogen.
- 2.4 Kleinordertoeslagen en administratiekosten staan op de prijslijst vermeld.

ARTIKEL 3 - BESTELLINGEN

- 3.1 Bestellingen, hoe dan ook genaamd, komen pas tot stand na uitdrukkelijke aanvaarding door Harco Loor. Deze uitdrukkelijke aanvaarding blijkt uit de schriftelijke bevestiging van Harco Loor, dan wel uit het feit dat zij uitvoering geeft aan de bestelling.
- 3.2 Mondelinge toezeggingen door en afspraken met ondergeschikten personeelsleden van Harco Loor binden deze laatste niet, dan nadat en voor zover zij door hem schriftelijk zijn bevestigd.

ARTIKEL 4 - INTELLECTUELE EIGENDOM/TEKENINGEN, MODELLEN, ONTWERPEN E.D.

- 4.1 In catalogussen, afbeeldingen, tekeningen e.d. vermelde gegevens zijn niet bindend, behalve voor zover deze uitdrukkelijk zijn opgenomen in een door Harco Loor ondertekende opdrachtbevestiging.
- 4.2 Harco Loor behoudt zich het auteursrecht en eigendomsrecht voor van bij de offerte verstrekte ontwerpen, afbeeldingen, monsters, stalen, modellen en alle andere zaken en mogen zonder haar schriftelijke toestemming noch geheel noch gedeeltelijk worden gekopieerd of aan enige derde ter hand gesteld.
- 4.3 Indien een aan Harco Loor gevraagde offerte niet wordt gevolgd door een overeenkomst, is de opdrachtgever aan wie wordt geoffreerd verplicht de offerte compleet met al het in het vorige lid genoemde binnen acht dagen aan Harco Loor te retourneren, bij gebreke waarvan Harco Loor zich het recht voorbehoudt om te dier zaken gemaakte kosten volledig door te berekenen, onverminderd het recht om van de opdrachtgever de kosten, schade en interesten voortvloeiende uit de inbreuk op genoemd auteurs- en eigendomsrecht op de opdrachtgever te verhalen.

ARTIKEL 5 - LEVERING

- 5.1 Alle leveringen geschieden franco binnen Nederland en af fabriek buiten Nederland. Af fabriek wil zeggen aflevering van de bestelde goederen aan de vervoerder of expediteur. Vanaf het moment dat de voor levering gereed zijnde zaken aldaar zijn geplaatst, staan en reizen zij voor risico van de opdrachtgever.
- 5.2 Alle zendingen geschieden per vervoermiddel van de keuze van Harco Loor en voor rekening en risico van opdrachtgever. Het aannemen van zaken door de vervoerder of expediteur zonder opmerking op de vrachtbrief of andere vervoersdocumenten geldt dan bewijs dat de zaken uiterlijk in goede staat verkeren.

ARTIKEL 6 - LEVERTIJD/RETOURZENDINGEN

- 6.1 De met opdrachtgever overeengekomen levertijd zijn nimmer als fataal aan te merken, tenzij uitdrukkelijk schriftelijk overeengekomen. De leveringstermijn gaat in op de dag van totstandkoming van de overeenkomst.
- 6.2 Indien vertraging ontstaat doordat voor de uitvoering van het werk tijdig bestelde materialen niet tijdig worden geleverd, wordt de levertijd zodanig verlengd als, alle omstandigheden in aanmerking genomen, redelijk is.
- 6.3 Overschrijding van de levertijd, door welke oorzaak ook, geeft de opdrachtgever geen recht op niet nakoming van enige jegens Harco Loor aangegane verplichting.
- 6.4 Retourzendingen moeten franco geschieden en zijn slechts na mondelinge c.q. schriftelijke toestemming van Harco Loor toegestaan. Het risico van de retourzendingen is voor opdrachtgever.

ARTIKEL 7 - GARANTIE/RECLAMES

- 7.1 Harco Loor staat in voor de deugdelijkheid en kwaliteit van de door hem geleverde goederen.
- 7.2 Opdrachtgever dient te allen tijde Harco Loor de gelegenheid te bieden een eventueel gebrek te herstellen. Gebreken ontstaan door normale slijtage, onoordeelkundige behandeling of onoordeelkundig of onjuist gebruik of die welke zich voordoen na wijziging door of namens opdrachtgever zelf of door derden aangebracht, blijven buiten de garantie.
- 7.3 Ten aanzien van gebreken, die geheel of ten dele het gevolg zijn enig overheidsvoorschrift inzake de aard of de kwaliteit der toegepaste materialen, wordt geen garantie gegeven.
- 7.4 Reclamering ter zake van uitwendig waarneembare gebreken of uitvoering van de bestelling dient te geschieden binnen 8 dagen na ontvangst van de goederen door de opdrachtgever, bij overschrijding van welk termijn elke aanspraak tegen Harco Loor terzake van die gebreken vervalt.

- 7.5 Indien een reclame resulteert in de vaststelling van fabricage- of montagefouten aan de zaken zal Harco Loor deze ter hare keuze kosteloos repareren of vervangen.
- 7.6 Het indienen van een reclame geeft geen recht tot uitstel van betaling.
- 7.7 De garantie geldt slechts indien opdrachtgever aan al zijn verplichtingen jegens Harco Loor (zowel financieel als anderszins) heeft voldaan.

ARTIKEL 8 - EIGENDOMSVOORBEHOUD

- 8.1 De goederen blijven uitsluitende eigendom van Harco Loor tot de volledige betaling van de factuur.
- 8.2 Ingeval opdrachtgever de betalingsverplichting jegens Harco Loor niet nakomt, is deze zonder ingebrekestelling gerechtigd de geleverde goederen terug te nemen. Opdrachtgever machtigt Harco Loor de plaats te betreden waar de goederen zich bevinden.

ARTIKEL 9 - AANSPRAKELIJKHEID

- 9.1 Harco Loor is niet aansprakelijk voor bedrijfsschade of andere indirecte schade met betrekking tot de geleverde goederen.
- 9.2 De aansprakelijkheid zal in ieder geval niet het betreffende factuurbedrag overschrijden.
- 9.3 Harco Loor is niet aansprakelijk voor schaden als gevolg van overmacht Onder overmacht wordt in ieder geval verstaan oorlog, oorlogsgevaar, burgeroorlog, rebellie, revolutie, oproer, werkstaking, transportmoeilijkheden, brand en andere ernstige storingen in het bedrijf van Harco Loor of dienst leveranciers en meer in het algemeen elke oorzaak die niet aan Harco Loor kan worden toegerekend.

ARTIKEL 10 - BETALINGSVOORWAARDEN

- 10.1 De facturen zijn betaalbaar onder aftrek van 3 % korting bij betaling binnen 8 dagen na factuurdatum of binnen 30 dagen na factuurdatum netto, tenzij anders nadrukkelijk schriftelijk overeengekomen.
- 10.2 Indien de opdrachtgever niet binnen de overeengekomen termijn betaalt, is Harco Loor gerechtigd na het verstrijken van bedoelde termijn aan opdrachtgever een vergoeding wegens renteverlies in rekening te brengen à 1% per maand of gedeelte van een maand.
- 10.3 De gehele koopprijs is onmiddellijk opeisbaar bij niet stipte betaling van de overeengekomen termijn op de vervaldag, wanneer opdrachtgever in staat van faillissement verkeert, surséance van betaling vraagt of zijn onder curatele stelling is aangevraagd, wanneer enig beslag op de zaak of vorderingen van opdrachtgever wordt gelegd, en wanneer deze overlijdt, in liquidatie treedt of wordt ontbonden.

- 10.4 Harco Loor is voorts gerechtigd naast de hoofdvordering en de rente van opdrachtgever te vorderen alle buitengerechtigde kosten, die door de niet (tijdige) betaling zijn veroorzaakt. Buitengerechtigde kosten zijn door opdrachtgever verschuldigd in ieder geval wanneer Harco Loor zich voor de invordering van de hulp van een derde heeft verzekerd. Zij zullen worden berekend overeenkomstig het incassotarief dat door de Nederlandse Orde van Advocaten wordt geadviseerd. Uit het enkele feit dat Harco Loor zich verzekerd heeft van de hulp van een derde blijkt de grootte van en de gehoudenheid tot betaling van de buitengerechtigde kosten.

ARTIKEL 11 - GESCHILLEN EN TOEPASSELIJK RECHT

- 11.1 Op alle door Harco Loor gesloten overeenkomsten is uitsluitend Nederlands recht van toepassing.
- 11.2 Alle geschillen die voortspruiten of opkomen in verband met de met Harco Loor gesloten overeenkomsten, staan uitsluitend ter kennisneming van de, in eerste instantie bevoegde rechter te Haarlem, of enig andere ter zake bevoegde rechter, indien Harco Loor zulks verkiest.

Deze Algemene Levering- en Betalingsvoorwaarden zijn geregistreerd bij de arrondissementsrechtbank in Haarlem onder akte 54/1999.

ARTICLE 1 - GENERAL

1.1 All offers, deliveries, services and sales are subject to these general sale conditions.

ARTICLE 2 - OFFERS/PRICES

- 2.1 All offers are made without engagement.
- 2.2 Unless explicitly stated otherwise, all prices are quoted for Franco delivery in the Netherlands and ex. Works outside the border.
- 2.3 If one or more of the cost price factors should be raised after quotation date - even though this is due to foreseeable circumstances - Harco Loor will be entitled to increase their price(s) accordingly.
- 2.4 Small order surcharges and administration fees are stated on the current price list.

ARTICLE 3 - ORDERS

- 3.1 Orders are only valid, after explicit acceptance by Harco Loor. This explicit acceptance is evident from a duly signed order confirmation from Harco Loor or actual execution of the order.
- 3.2 Verbal promises by and arrangements with subordinate employees of Harco Loor shall not be binding upon Harco Loor until and insofar as they have been confirmed by the latter in writing.

ARTICLE 4 - DRAWINGS, SAMPLES, DESIGNS

- 4.1 Any data mentioned in catalogues, illustrations, drawings etc. shall not be binding, unless explicitly inserted in a duly signed order confirmation by Harco Loor.
- 4.2 Harco Loor reserve the ownership and copyright with regard to all data provided during offering, such as designs, pictures, photos, samples, models, proto types etc. and it not allowed to copy - neither wholly or partially - and to show anything to third parties without Harco Loor's written permission.
- 4.3 If an offer is not followed by an agreement, the principal is obliged to return the offer with all data as mentioned in § 4.2 to Harco Loor within 8 days. Harco Loor reserve all rights to pass on any costs relating to this case; remaining in full force the right to claim all damages, costs and interests resulting from the violation of mentioned copyright and ownership on the principal.

ARTICLE 5 - DELIVERY

5.1 All deliveries are Franco in and ex. Works outside the Netherlands. Ex. works means delivery of the goods to a forwarding agent or carrier. From that moment on the goods are considered, as being

delivered and consequently purchaser shall bear the risk with regard to any and all direct and indirect damage that may be caused during transport.

5.2 The means of transport for sending the goods will be determined by Harco Loor and the merchandise will be dispatched for account and risk of the purchaser. The acceptance of the goods by a forwarding agent or carrier without any remark on the Bill of Lading or other transport documents proves that the delivered goods are in perfect shape.

ARTICLE 6 - DELIVERY-TIME/RETURN SHIPMENTS

- 6.1 Unless explicitly agreed in writing, delivery-times are not considered as fatal. The delivery period shall run from the date of concluding the agreement.
- 6.2 In case of delay due to a delay in the delivery of materials ordered in time for the execution of the work, the delivery-time shall be extended by such a period, as is reasonable taking all circumstances into account.
- 6.3 Any delay in delivery-time - through any cause or whatsoever - shall not entitle the purchaser not to fulfil any obligation vis-à-vis Harco Loor.
- 6.4 Return shipments are only being allowed after verbal or written approval from Harco Loor and will be done for account and risk of the purchaser.

ARTICLE 7 - GUARANTEE AND CLAIMS

- 7.1 Harco Loor guarantees both the soundness and quality of the goods supplied by him.
- 7.2 The purchaser shall give Harco Loor the opportunity to carry out repairs. Harco Loor shall not be responsible for defects as a result of normal wear, incompetent treatment or incorrect use and defects which occurs after alteration by or on behalf of the purchaser or put on by a third party are also not subject to guarantee.
- 7.3 No guarantee is given in respect of faults that are wholly or partly due to any government regulation with regard to the nature of quality of the materials used.
- 7.4 Any claims in respect of outwardly the purchaser shall make visible defects or execution of the order not later than 8 days after receipt of the goods. Any claims vis-avis Harco Loor in respect of such defects becoming void after expiration of the said term.
- 7.5 Any defects as a consequence of manufacturing and assembly faults will be repaired by Harco Loor free of charge.
- 7.6 Lodging a claim does not give the right to postpone payment.
- 7.7 Guarantee shall only apply if purchaser has fulfilled its obligations against Harco Loor (both financial as otherwise).

ARTICLE 8 - OWNERSHIP

- 8.1 All goods remain property of Harco Loor until the invoice is completely paid.
- 8.2 In case of non-payment by the purchaser, Harco Loor is entitled to undertake any action in regaining the delivered goods. Purchaser authorizes Harco Loor to intrude the place of the purchased goods.

ARTICLE 9 - LIABILITY

- 9.1 Harco Loor shall not be held liable for any claim in respect of operational loss or other indirect loss.
- 9.2 Any claim exceeding the amount of invoice shall be excluded.
- 9.3 Harco Loor cannot be held liable for any and all circumstances beyond their control, such as war, danger of war, civil war, rebellion, revolution, revolt, strikes, transport difficulties, fire and serious interruptions in the business activities of Harco Loor or Harco Loor's suppliers and in general any cause which can not be blamed to Harco Loor.

ARTICLE 10 - TERMS OF PAYMENT

- 10.1 Invoices are payable under deduction of 3% discount when payment is settled within 8 days after date of invoice or within 30 days nett, unless explicitly agreed otherwise in writing.
- 10.2 If the purchaser fails to pay by the agreed date, he shall be deemed ipso jure to be in default, and Harco Loor shall be entitled, without any notice of default being required, to charge interest at a percentage of 1 % per month or a part of the month.
- 10.3 The amount of invoice is immediately demanded when payment is not be settled on the agreed date or when purchaser is in a process of bankruptcy, applies for suspension of payment or curator bonis, attachment on property or requisitions of purchaser and in case of death or liquidation.
- 10.4 Harco Loor is also entitled to requisite in addition all judicial and extra-judicial charges falling on the collection of the debt.

ARTICLE 11 - DISPUTES AND APPLICABLE LAW

- 11.1 For all agreements full or in part the Dutch law will be in force.
- 11.2 Any disputes will exclusively be judged by the country and crown court in Haarlem.

These general conditions of Delivery and Payment are registered with the district court in Haarlem no. 54/1999.

TERMS OF SALE

This price list cancels all the previous ones.

The prices are in EUR without VAT.

The prices are only recommended.

De in deze catalogus afgebeelde kleuren kunnen iets afwijken van de werkelijke kleuren van de verlichtingsarmaturen. Harco Loor Design B.V. behoudt zich het recht voor om haar eigen modellen zonder voorafgaande kennisgeving te wijzigen.

We reserve the right to technical or aesthetic modifications. Please allow for color discrepancies between the illustrations in this catalogue and the actual products. Harco Loor Design B.V. reserves the right to introduce any changes to its own models, without prior notice.

Technische und formale Änderungen vorbehalten. Die in diesem Katalog gedruckten Farben können von den tatsächlichen Farben der Lampen abweichen. Harco Loor Design B.V. behält sich das Recht vor Änderungen vorzunehmen, ohne sofortige Benachrichtigung.

Sous réserve de modifications techniques et de forme. Les couleurs imprimées dans ce catalogue peuvent varier des couleurs réelles des lampes. Harco Loor Design B.V. se réserve le droit d'apporter aux propres modèles, sans aucun préavis, n'importe quel modification qu'il retienne nécessaire.

Al onze designs worden in onze fabriek in Haarlem ontworpen en geproduceerd. Er worden uitsluitend kwalitatief hoogwaardige materialen als roestvaststaal en kristal gebruikt.

All our lighting fixtures are designed and manufactured in our own factory in Haarlem, the Netherlands. Only high quality materials, such as stainless steel and crystals are used.

Alle unsere Beleuchtungskörper werden in unserer Fabrik in Haarlem, Niederlande entworfen und hergestellt. Es wird ausschließlich hochwertiges Material, wie Edelstahl und Kristal, verwendet.

Tous nos appareils sont conçus et fabriqués dans notre usine à Haarlem aux Pays-Bas. Nous utilisons exclusivement des matériaux de grande qualité, comme inox et cristal.

Photography Pieter E. Kamp
Art Direction Pascal Hogerheijde

Edition 2021 - 2022
All rights reserved



HARCO LOOR DESIGN OFFICE

Tappersweg 81-83	P.O. Box 6145	+31 (0)23 538 81 17
2031 ET Haarlem	2001 HC Haarlem	info@harcoloor.com
The Netherlands	The Netherlands	www.harcoloor.com

SHOWROOM

Gedempte Oude Gracht 74
2011 GT Haarlem
+31 (0)23 538 81 17

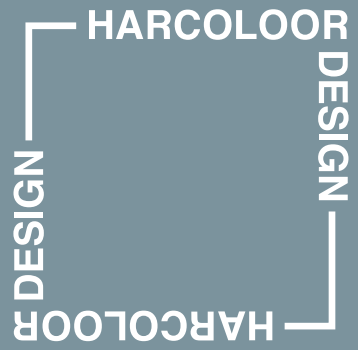

HARCOLOOR.COM