

PRICE LIST / LISTA DE PRECIOS  
2022

EUROS VAT. EXCLUDED  
EUROS IVA NO INCLUIDO

Alle Preise zzgl. ges. MwSt.

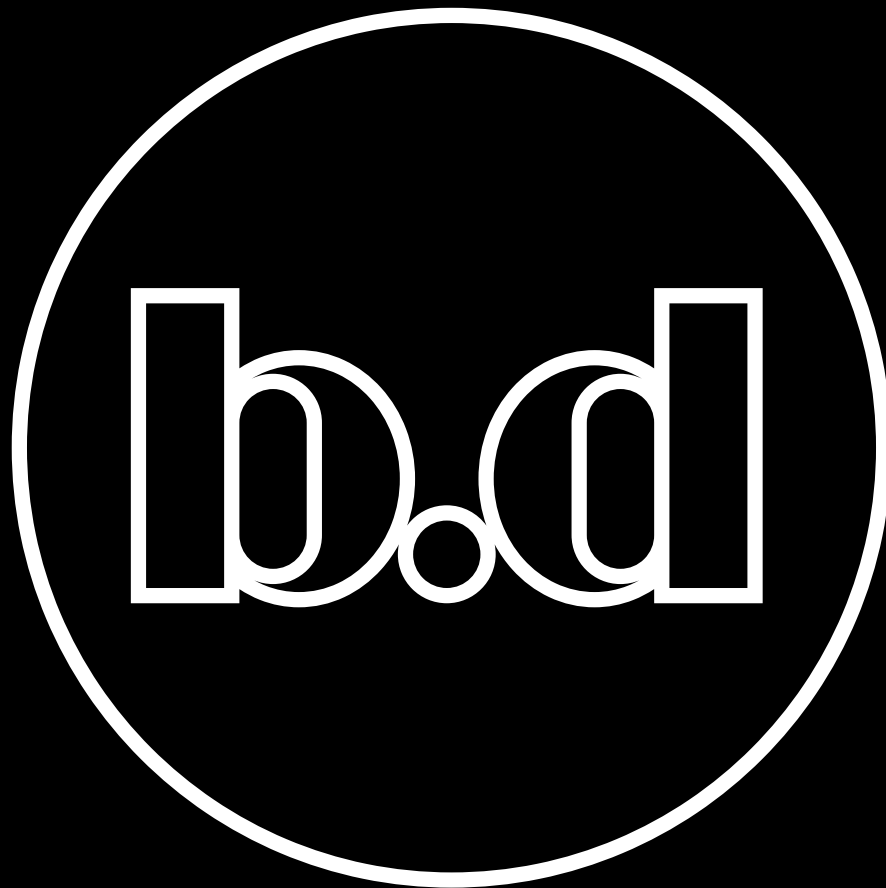



## AWARDS AND RECOGNITIONS / PREMIOS Y RECONOCIMIENTOS

---

### COMPANY AWARDS / PREMIOS A LA EMPRESA

1989	PREMIO NACIONAL DE DISEÑO
1990	EUROPEAN COMMUNITY DESIGN PRIZE

### AWARDS / PREMIOS

1974	DELTA AWARD	ESTANTERÍA HIALINA, Anna Bohigas, Lluís Clotet y Oscar Tusquets
1975	GOLDEN DELTA AWARD	ESPEJO LUMINOSO, Mireia Riera
1976	GOLDEN DELTA AWARD	MESA SEVILLA, Pep Bonet y Cristian Cirici
1979	GOLDEN DELTA AWARD	CAMPANA DIÁFANA, Lluís Clotet y Oscar Tusquets
1980	GOLDEN AND OPINION DELTA AWARD	ESTANTERÍA HYPÓSTILA, Lluís Clotet y Oscar Tusquets
1984	SILVER DELTA AWARD	CENICERO SURCO, Juancho de Mendoza y Maite Oriol
1986	SILVER DELTA AWARD	CATENARIA, Pep Bonet
1986	GOLDEN DELTA AWARD 25 YEARS	ESTANTERÍA HIALINA, Lluís Clotet y Oscar Tusquets
1988	GOLDEN DELTA AWARD	SILLÓN COQUETA, Pete Sans
1991	SILVER DELTA AWARD	PARAGÜERO BARCELONÉS, Pep Bonet
1997	SILVER DELTA AWARD	CAMPANA EXTRACTORA DIÁFANA, Lluís Clotet y Oscar Tusquets
2007	GOLDEN DELTA AWARD	LOS BANCOS SUIZOS, Alfredo Häberli
2009	SILVER DELTA AWARD	TABLE B, Konstantin Grcic
2011	SILVER DELTA AWARD	CHAIR B, Konstantin Grcic
2011	RED DOT DESIGN AWARD	TABLE B, Konstantin Grcic
2013	SILVER DELTA AWARD	BENCH B, Konstantin Grcic
2014	SILVER DELTA AWARD	COLECCIÓN GARDENIAS, Jaime Hayon
2017	ECODISEÑO AWARD	REMIX COLLECTION, Curro Claret y Ramón Úbeda
2019	INTERIOR NYCDESIGN AWARD	BUTACA GRASSO, Stephen Burks
2020	GOLDEN DELTA AWARD	BUTACA GRASSO, Stephen Burks

### ADI-FAD AWARDS SELECTION / PREMIOS ADI-FAD

1971	LÁMPARA JIPI
1972	LÁMPARA FLAMINGO, LÁMPARA CUC, VELÓN, NEGRO
1974	LÁMPARA PIA, SILLA SEVILLA, LÁMPARA SYLVESTRE, CAMPANA CAMPANAE, HARPO, SCALA DE MILAN, BANCO CATALANO
1975	LÁMPARA POSTAL PIRAMIDE, BUZONES SARDINEL, LÁMPARA GALIA
1976	SILLA MOZART, CARRITO VERSÁTIL
1977	SERIE RACOR, EL GERRO
1978	HERRAJES MODERNISTAS, LÁMPARA TALLO, MESA CASINO, TAULETA
1979	CENICERO HOMENAJE A BARRAQUER, SERIE JARDÍN, PERCHA TECLA, LA FIGURA GALA
1980	GALÁN DE BAÑO
1981	CHAISE LONGUE DU CHAMP, GUARDADISCOS
1984	RELOJ SOLAR, BUZÓN 3/4/5, MUEBLE ROBERTO, ESPEJO GALANTE, PAPELERA ESCUADRA, TABURETE DUPLEX-SINGLE, TIRADOR MODULAR
1986	LÁMPARA BIB-LUZ LIBRO, LÁMPARA VAGUE STELLE, MESA MESITA, FAROLA Y APLIQUE TATI, MESA PHIDEA, LÁMPARA ARAÑA, LÁMPARA BIB-LUZ SEMIESFERA
1988	ESTANTERÍA CORNISA, MESA METARRÍGIDA, ALFOMBRA LUNA, APLIQUE TEA, SILLA METALÍSTICA, MESA ORBITA, SERIE ZORAIDA, ALFOMBRA TIERRA, ALFOMBRA LOTZ, ESTANTERÍA TALAYA, MESA COMITÉ, ALFOMBRA PXOCK
1990	MESA ARÁCNIDA, LÁMPARA MITRAL, LÁMPARA BIB LUZ DOBLE
1992	ESPEJO MIRALLMAR, CENICERO ZENIO, ESTANTERÍA AUTÓNOMA, TABURETE TUT ANK AHMON, MESA TORRE LLIMONA, LÁMPARA CÁSTOR, IMHOTEP, ATRIL DE ALEJANDRÍA, SILLÓN LEDA
1993	LÁMPARA PÓLUX, SILLA BIB, SERIE RACOR II
1995	ESTANTERÍA PHANTASMA, CENICERO PAPELERA PALAU, SERIE E.T.
1997	ALFOMBRA VÉRTIGO, LÁMPARA SKYLINE, MESA CHARLES, PARAGÜERO PLEC, LÁMPARA PLOMADA
2001	MESA ROMANA PREMIO DESIGN FOR THE WORLD
2003	BANCO BDLOVE
2005	MAILBOX MAIL ME
2007	SHOWTIME COLLECTION
2009	CABINET TOUT VA BIEN
2012	MESA GAULINO, FREE PORT
2014	CHANDLO
2016	DREAMS CABINET, FANG COLLECTION
2017	REMIX COLLECTION
2018	DALIA CABINET

# INDEX

---

## 7 BD PRODUCT FINISHES / ACABADOS DE PRODUCTO

### STORAGE AND SHELVING / CONTENEDORES Y ESTANTERÍAS

---

- 20 DREAMS CABINET - Cristian Zuzunaga
- 22 COUTURE CABINET - Färg & Blanche
- 22 AQUÁRIO CABINET - Campana Brothers
- 23 SHANTY - Doshi Levien
- 24 MULTILEG SHOWTIME CABINET - Jaime Hayon
- 30 TOUT VA BIEN - Antoine et Manuel
- 33 FREE PORT - Martí Guixé
- 33 HIALINA - Lluís Clotet & Oscar Tusquets
- 34 HYPÓSTILA shelving / estantería - Lluís Clotet & Oscar Tusquets
- 38 CORNISA shelving / estantería - Lluís Clotet & Oscar Tusquets
- 39 ESBELTA shelving / estantería - Lluís Clotet & Oscar Tusquets

### TABLES / MESAS

---

- 40 GAULINO - Oscar Tusquets
- 41 TABLE B - Konstantin Grcic
- 54 EXPLORER DINING TABLE - Jaime Hayon
- 56 MULTILEG LOW TABLE - Jaime Hayon
- 57 MONKEY SIDE TABLE - Jaime Hayon
- 58 SIDE TABLE B - Konstantin Grcic
- 58 2001 SIDE TABLES - Otto Canalda & Ramón Úbeda
- 58 EXPLORER SIDE TABLE - Jaime Hayon

### ARMCHAIRS / BUTACAS

---

- 60 DINO - Jaime Hayon
- 61 GRASSO - Stephen Burks
- 62 LITTLE COUTURE - Färg & Blanche
- 62 COUTURE - Färg & Blanche
- 63 SHOWTIME POLTRONA - Jaime Hayon
- 64 LOUNGER - Jaime Hayon
- 65 LOW LOUNGER - Jaime Hayon
- 66 GARDENIAS COLLECTION OUTDOOR- Jaime Hayon
- 67 GARDENIAS COLLECTION INDOOR- Jaime Hayon
- 68 DALILIPS - Salvador Dalí
- 68 GAULINO EASY CHAIR - Oscar Tusquets

---

## CHAIRS AND STOOLS / SILLAS Y TABURETES

---

- 69 GAULINETTA chair / *silla* - Oscar Tusquets
- 69 GAULINO chair / *silla* - Oscar Tusquets
- 70 CHAIR B chair / *silla* - Konstantin Grcic
- 70 MINIVARIUS chair / *silla* - Oscar Tusquets
- 71 SHOWTIME & SHOWTIME NUDE chair / *silla* - Jaime Hayon
- 84 JAMAICA stool / *taburete* - Pepe Cortés
- 85 BINARIA stool / *taburete* - Jordi Badía & Otto Canalda
- 85 GRASSO stool / *taburete* - Stephen Burks
- 85 JANET stool / *taburete* - Ramón Úbeda & Otto Canalda

---

## ACCESSORIES / ACCESORIOS

---

- 86 MIRALLMAR mirror / *espejo* - Eduard Samsó
- 86 SHOWTIME mirror / *espejo* - Jaime Hayon
- 87 KING KONG mirror / *espejo* - Jaime Hayon
- 87 SHIVA flower vase / *florero* - Ettore Sottsass Jr.
- 87 GARDENIAS vases / *jarrones* - Jaime Hayon
- 88 SHOWTIME vases / *jarrones* - Jaime Hayon
- 89 HAPPY SUSTO vases / *jarrones* - Jaime Hayon
- 89 HAPPY YETI vases / *jarrones* - Jaime Hayon
- 89 EXPLORER vases / *jarrones* - Jaime Hayon
- 90 MONKEY COAT HANGER hanger / *colgador* - Jaime Hayon
- 90 CASA DE FAMILIA bottle / *botella* - Josep Maria Jujol
- 91 HAPPY HOUR trolleys / *carritos* - Alfredo Häberli
- 91 PLEC umbrella stand / *paragüero* - Isabel Gamero & Jordi Pérez
- 92 3-4-5 mailbox / *buzón* - Lluís Clotet & Oscar Tusquets
- 93 DIAFANA extractor / *campana* - Lluís Clotet & Oscar Tusquets

---

## LIGHTING / ILUMINACIÓN

---

- 94 FLAMINGO - Álvaro Siza Vieira
- 94 OLVIDADA - Pepe Cortés

---

## OUTDOOR & PUBLIC SEATING / EXTERIOR Y ASIENTOS PÚBLICOS

---

- 96 EL POETA bench / *banco* - Alfredo Häberli
- 97 BENCH B - Konstantin Grcic
- 98 CATALANO bench / *banco* - Lluís Clotet & Oscar Tusquets
- 98 PERFORANO bench / *banco* - Lluís Clotet & Oscar Tusquets

---









## ART EDITIONS

---

- 101 CALVET hanger / *colgador* - Antoni Gaudí
- 101 CALVET stool / *taburete* - Antoni Gaudí
- 101 CALVET armchair / *sillón* - Antoni Gaudí
- 102 CALVET chair / *silla* - Antoni Gaudí
- 102 CALVET mirror / *espejo* - Antoni Gaudí
- 103 CALVET bench / *banco* - Antoni Gaudí
- 103 BATLLÓ bench / *banco* - Antoni Gaudí
- 103 BATLLÓ chair / *silla* - Antoni Gaudí
- 104 GAUDÍ door knobs / *herrajes* - Antoni Gaudí
- 104 GAUDÍ handles display / *expositor* - Antoni Gaudí
- 105 PORTLLIGAT sunbed / *tumbona* - Salvador Dalí
- 105 VIS-À-VIS DE GALA - Salvador Dalí
- 106 LEDA armchair / *butaca* - Salvador Dalí
- 106 LEDA low table / *mesa baja* - Salvador Dalí
- 107 BRACELLI lamp / *lámpara* - Salvador Dalí
- 107 MULETAS lamp / *lámpara* - Salvador Dalí
- 107 CAJONES lamp / *lámpara* - Salvador Dalí
- 107 RINOCERÓNICO knob / *tirador* - Salvador Dalí
- 108 XAI - Salvador Dalí
- 108 INVISIBLE PERSONAGE / *PERSONAJE INVISIBLE* - Salvador Dalí
- 109 CRISTALLO - Alessandro Mendini
- 109 TIGER GAULINO - Oscar Tusquets
- 109 METTSASS - Ettore Sottsass Jr.
- 110 REmix Vol. 1 candleholder / *candelabro* - Curro Claret
- 110 REmix Vol. 2 CABINET - Ramón Úbeda
- 111 REmix Vol. 5 - Belén Moneo
- 111 REmix Vol. 6 - Las Ánimas
- 112 WALKING HEN candleholder / *candelabro* - Aisha Al Sowaidi
- 112 IS-DHER VASES - Hind Bint Majid Al Qassimi
- 112 TAOLA SIDE TABLE - Gazzaz Brothers
- 113 LUNAR TALE mirror / *espejo* - Loulwa Al Radwan
- 113 TALISMAN CABINET - Maysam Al Nasser
  
- 114 GENERAL CONDITIONS OF SALE / *CONDICIONES GENERALES DE VENTA*











# BD FINISHES / ACABADOS

## LEATHER / PIELES

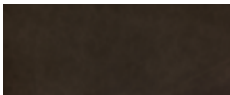
REF	NAME / TIPOLOGÍA	DESCRIPTION / DESCRIPCIÓN	COLOURS / COLORES	
F	<b>Florida</b> (recommended for contract use / recomendado para uso contract)	<b>Composition / Composición</b> Raw hide leather (corrected grain) through dyeing aniline / <i>Piel de vacuno (flor corregida) tintada en anilina</i> <b>Tear resistance / Resistencia al desgarro</b> >20N (UNI EN ISO 3377-1) <b>Crack resistance / Resistencia a la flexión</b> 50.000 Cycles / Ciclos (UNI EN ISO 5402) <b>Dry rub fastness / Solidez del color a frote seco:</b> 1.000 Cycles / Ciclos Vol. >4 Grey scale / Escala de grises (UNI EN ISO 11640) <b>Light fastness / Solidez del color a la luz</b> Vol. >6 Blue scale / Escala de azules (UNI EN ISO 105-B02) <b>Fire test / Tratamiento ignifugo:</b> BS5852 CRib5 (optional / opcional) UNI EN 1021-1 UNI EN 1021-2 NFPA 260/UFAC California TB 117 Section E	Black / Negro – F10 	Yellow / Amarillo – F25 
			Camel – F15 	Dark orange / Teja – F20 
			Charcoal grey / Gris antracita – F27 	
P	<b>Panama</b> (recommended for contract use / recomendado para uso contract)	<b>Composition / Composición</b> Raw hide leather (corrected grain) / <i>Piel de vacuno (flor corregida)</i> <b>Tear resistance / Resistencia del desgarro</b> 20N (EN3377-1) <b>Crack resistance / Solidez a la flexión</b> 50.000 Cycles / Ciclos (EN ISO 5402) <b>Dry rub fastness / Solidez del color a frote seco</b> 1.000 Cycles / Vol. 5 Grey scale / 1.000 Ciclos / Vol. 5 Escala de grises (ISO 11640) <b>Wet rub fastness / Solidez del color a frote húmedo</b> 250 Cycles / Vol. 5 Grey scale / 250 Ciclos / Vol. 5 Escala de grises (ISO 11640) <b>Light fastness / Solidez a la luz</b> 72 h. exposition / Vol. 5 Grey scale / 72 h. de exposición / Vol. 5 Escala de grises (EN ISA 105-B02) <b>Fire test / Tratamiento ignifugo</b> BS5852 CRib5 (optional / opcional) UNI EN 1021-1 UNI EN 1021-2 NFPA 260/UFAC California TB 117 Section E	Sand / Arena – P01 	
			White / Blanco – P04 	
			Black / Negro – P10 	
			Dark brown / Marrón oscuro – P15 	

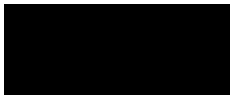
# BD FINISHES / ACABADOS

## LEATHER / PIELES

REF	NAME / TIPOLOGÍA	DESCRIPTION / DESCRIPCIÓN	COLOURS / COLORES	
V	<b>Vintage</b> (recommended for domestic use / recomendado para uso doméstico)	<b>Composition / Composición</b> NABUK: Through dyeing aniline <i>Piel NABUK tintado en anilina</i> <b>Tear resistance / Resistencia al desgarro</b> >20N (UNI EN ISO 3377-1:2012) <b>Dry rub fastness / Solidez del color a frote seco</b> 50 cycles / Vol. >3 Grey scale <i>50 ciclos / Vol. &gt;3 Escala de grises (ISO 11640)</i> <b>Light fastness / Solidez del color a la luz</b> Vol. >3 Blue scale / Vol. >3 Escala de azules (EN ISA 105-B02) <b>Fire test / Tratamiento ignífugo</b> UNI EN 1021-1 UNI EN 1021-2 NFPA 260 / UFAC FS191 Método S903 - Port Authority of New York IMO Resolution A.652 (16) California TB 117 Section E	<b>Aged Black</b> <i>Negro envejecido – V10</i>	<b>Grey / Gris – V22</b>
				
			<b>Aged Camel</b> <i>Camel envejecido – V18</i>	<b>Sepia – V23</b>
				
			<b>Aged Testa di Moro / Testa di Moro envejecido – V19</b>	<b>Creta – V24</b>
				
S	<b>Sauvage</b> (recommended for domestic use / recomendado para uso doméstico)	<b>Composition / Composición</b> Chrome tanned raw hides. Full grain, aniline dyeing. <i>Piel bovina curtida. Anilina, plena flor.</i> <b>Dry rub fastness / Solidez del color al frote en seco:</b> 150 cycles / ciclos UNI EN ISO 11640 <b>Wet rub fastness / Solidez del color al frote en húmedo:</b> 50 cycles / ciclos UNI EN ISO 11640 <b>Resistance to water drop / Solidez a la gota de agua:</b> UNI EN ISO 15700 >3 Grey scale / Escala de grises <b>Physical characteristics / Características físicas</b> Tear resistance $\geq$ 40N UNI EN ISO 3377-2 <b>Flammability / Tratamiento ignífugo</b> BS 5852:2006 Cigarette test BS 5852:2006 Match test UNI EN 1021-1:2014 Cigarette test UNI EN 1021-2:2014 California TB117 Section E	<b>Black – S40</b>	<b>lby – S46</b>
				
			<b>Argila – S45</b>	<b>Pomelo – S50</b>
				

## VINTAGE & SAUVAGE LEATHER IMPERFECTIONS / IMPERFECCIONES DE LAS PIELES VINTAGE Y SAUVAGE

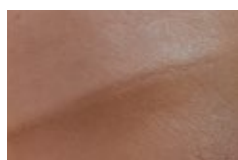

Wrinkles / Arrugas

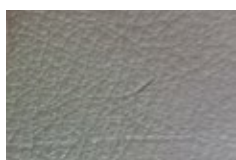

Scar / Cicatriz



Insect bites / Picadas de insectos

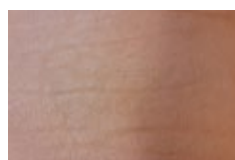

Neck folds / Pliegues del cuello





Warts / Verrugas

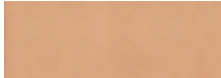
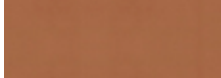

## BD FINISHES / ACABADOS

### LEATHER / PIELES

REF	NAME / TIPOLOGÍA	DESCRIPTION / DESCRIPCIÓN	COLOURS / COLORES
	Hide / Cuero		Natural – C13  Toasted / Tostado – C20  Black / Negro – C10 

### LEATHER CLEANING AND MAINTENANCE / LIMPIEZA Y MANTENIMIENTO DE LAS PIELES

- Avoid direct light.
- Keep from direct heat.
- Dust regularly with a soft and dry cloth.
- Clean with a slightly damp cloth and mild soap. Dry immediately after treatment. Do not rub. Use a light circular motion working toward the center of the stain.
- To Moisturize the leather we recommend to apply natural neutral creams.
- Avoid sharp objects.
- Do not use household cleaners.
  
- Evitar exponer la piel al sol directo.
- Mantenga la piel alejada del calor directo.
- Limpiar el polvo regularmente con un paño suave y seco.
- Las manchas se pueden limpiar con un paño ligeramente húmedo y jabón neutro. Secar inmediatamente después del tratamiento. No frote. Use un ligero movimiento circular hacia el centro de la mancha.
- Es aconsejable aplicar cremas naturales neutras incoloras, para hidratar la piel.
- Evitar objetos punzantes.
- No usar limpiadores del hogar

### LEATHER CHARACTERISTICS / CARACTERÍSTICAS DE LAS PIELES

THE NATURAL CHARACTERISTICS OF LEATHER makes this product uneven as of all products that come from nature. Correcting processes make the leathers surface texture even and consequentially less natural. Grain changes, marks and scars caused during the life of an animal are attributes of fine quality and unaltered leather. Wrinkles, bites or other imperfections cannot be considered as defects in leather, but proof of its high quality.

The wrinkles on the surface are part of the original design. Both the number and size of the wrinkles can vary as natural leathers are being used. The elasticity itself enhances the diversity and variability of the wrinkles.

*Las características naturales de la piel hacen que sea un producto irregular, como todos los productos que provienen de la naturaleza. Cuantos más procesos de rectificación sufre una piel más regular es la superficie, pero es menos natural. Las pequeñas cicatrices o marcas son características de una piel de primera calidad con poco rectificado, causadas por pequeñas heridas que el propio animal ha tenido a lo largo de su vida. Dichas marcas o cicatrices no pueden considerarse defectos de la piel pues son una muestra de su alta calidad.*









*Las arrugas producidas en la superficie son originales del propio diseño. Tanto el número de arrugas como el tamaño pueden variar debido a utilizar pieles naturales. La propia elasticidad potencia la diversidad y variabilidad de las arrugas.*

# BD FINISHES / ACABADOS

## FABRICS / TELAS



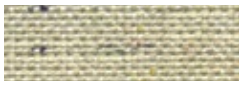











### COMPOSITION KEY / CLAVES DE COMPOSICIÓN

PES - POLYESTER / POLIÉSTER	WO - NATURAL WOOL / LANA NATURAL
PP - POLYPROPYLENE / POLIPROPILENO	CV - VISCOSE / VISCOSA
CO - COTTON / ALGODÓN	MA - MINERAL FIBRE / FIBRA MINERAL

REF	NAME / TIPOLOGÍA	DESCRIPTION / DESCRIPCIÓN	COLOURS / COLORES
CAT 1	Libra (recommended for contract use / recomendado para uso contract)	<p><b>Composition / Composición</b> 50%PP 32%PES 18%CO</p> <p><b>Abrasion resistance (End point) / Resistencia a la abrasión (Rotura hilos):</b> EN ISO 12947-2:1998 - 66000</p> <p><b>Pilling resistance / Resistencia al pilling</b> EN ISO 12945/2:2000; Modified martindale method (2000 and 7000 cycles) (Scale from 1 worst to 5 best): 4-5 <i>EN ISO 12945/2:2000; Método martindale modificado (2000 y 7000 ciclos) (Escala de valores de 1 peor a 5 mejor): 4-5</i></p> <p><b>Assessment of ignitability / Reacción al fuego</b> BS 5852 Source 0 BS 5852 Source 1 (opcional) EN 1021- Part 1:2006 EN 1021- Part 2:2006 (opcional) CAL TB 117:2013 California NFPA 260:2013 BS 7176 Low Hazard (opcional) UNI 9175 Clase 3IM (opcional)</p> <p><b>Lightfastness / Solidez a la luz artificial</b> EN ISO 105-B02:1998 &amp; EN ISO 105 B02/A01:2002 Colour degradation on blue scale (Scale from 1 worst to 8 best): 6-7 <i>Degradación de color en la escala de azules (Escala de 1 peor a 8 mejor): 6-7</i></p> <p><b>Colour fastness to rubbing (dry and wet) / Solidez al frote (seco y húmedo)</b> EN ISO 105-X12:2002 (Scale from 1 worst to 5 best): 4-5 <i>(Escala de valores de 1 peor a 5 mejor): 4-5</i></p> <p><b>Washing conditions / Condiciones de lavado</b> ☑ ☒ ☒ ☒ ☒ ☒</p>	<p>Brown / Marrón – TL10 </p> <p>Beige – TL20 </p> <p>Pale Pink / Rosa pálido – TL29 </p> <p>Green / Verde – TL37 </p> <p>Grey / Gris – TL49 </p> <p>Dark Brown / Marrón oscuro – TL53 </p> <p>Pink / Rosa – TL62 </p>
CAT 2	Iris (recommended for domestic use / recomendado para uso doméstico)	<p><b>Composition / Composición</b> 41%CO 29%PES 24%PP 6%CV</p> <p><b>Abrasion resistance (End point) / Resistencia a la abrasión (Rotura hilos)</b> EN ISO 12947-2:1998 - 32000</p> <p><b>Pilling resistance / Resistencia al pilling</b> EN ISO 12945/2:2000; Modified martindale method (2000 and 7000 cycles) (Scale from 1 worst to 5 best): 4 <i>EN ISO 12945/2:2000; Método martindale modificado (2000 y 7000 ciclos) (Escala de valores de 1 peor a 5 mejor): 4</i></p> <p><b>Assessment of ignitability / Reacción al fuego</b> BS 5852 Source 0 BS 5852 Source 1 (opcional) EN 1021- Part 1:2006 EN 1021- Part 2:2006 (opcional) CAL TB 117:2013 California NFPA 260:2013</p> <p><b>Lightfastness / Solidez a la luz artificial</b> EN ISO 105-B02:1998 &amp; EN ISO 105 B02/A01:2002 Colour degradation on blue scale (Scale from 1 worst to 8 best): 5-6 <i>Degradación de color en la escala de azules (Escala de 1 peor a 8 mejor): 5-6</i></p> <p><b>Water repellency / Repelencia al agua (Hidrofobia)</b> AATCC 79:2000 (value &gt; 300): 70</p> <p><b>Oil repellency / Repelencia al aceite (Oleophobia)</b> EN ISO 14419:1999 / AC:2006 - AATCC 118:2002 (Scale from 1 worst to 8 best): 5-6 <i>(Escala de valores de 1 peor a 8 mejor): 5-6</i></p> <p><b>Washing conditions / Condiciones de lavado</b> ☑ ☒ ☒ ☒ ☒ ☒</p> <p>Repellence Protection / Acabado Protector Manchas</p>	<p>Beige – TI05 </p> <p>Grey / Gris – TI11 </p> <p>Brown / Marrón – TI20 </p>

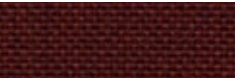
# BD FINISHES / ACABADOS

## FABRICS / TELAS

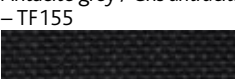



REF	NAME / TIPOLOGÍA	DESCRIPTION / DESCRIPCIÓN	COLOURS / COLORES
CAT 2	<b>Gaudí</b> (recommended domestic & contract use / uso doméstico y contract)	<p><b>Composition / Composición</b> 60%PP 35%PES 5%CO</p> <p><b>Abrasion resistance (End point) / Resistencia a la abrasión (Rotura hilos):</b> EN ISO 12947-2:1998 - 46000</p> <p><b>Pilling resistance / Resistencia al pilling</b> Abrasion resistance (Change of aspect: 3000 cycles) EN ISO 12947/4:1998 &amp; EN 14465:2003/A1:2006 (Scale from 1 worst to 5 best): 5 <i>EN ISO 12945/2:2000; Método martindale modificado (2000 y 7000 ciclos)</i> (Escala de valores de 1 peor a 5 mejor): 5</p> <p><b>Assessment of ignitability / Reacción al fuego</b> BS 5852 Source 0 BS 5852 Source 1 (opcional) EN 1021- Part 1:2006 EN 1021- Part 2:2006 (opcional) CAL TB 117:2013 California NFPA 260:2013 BS 7176 Low Hazard (opcional) UNI 9175 Clase 3IM (opcional)</p> <p><b>Lightfastness / Solidez a la luz artificial</b> EN ISO 105-B02:1998 &amp; EN ISO 105 B02/A01:2002 Colour degradation on blue scale (Scale from 1 worst to 8 best): 5-6 <i>Degradación de color en la escala de azules (Escala de 1 peor a 8 mejor): 5-6</i></p> <p><b>Washing conditions / Condiciones de lavado</b>  </p>	<p>Light Grey / Gris claro – TG02 </p> <p>Grey / Gris – TG12 </p> <p>Pale Pink / Rosa pálido – TG29 </p> <p>Purple / Morado – TG48 </p> <p>Black / Negro – TG53 </p> <p>Orange / Naranja – TG60 </p>
CAT 3	<b>Fusion</b> (recommended for contract use / recomendado para uso contract)	<p><b>Composition / Composición</b> 34%WO 28%PES 23%PP 15%CO</p> <p><b>Abrasion resistance (End point) / Resistencia a la abrasión (Rotura hilos):</b> EN ISO 12947-2:1998 - 62000</p> <p><b>Pilling resistance / Resistencia al pilling</b> EN ISO 12945/2:2000; Modified martindale method (2000 and 7000 cycles) (Scale from 1 worst to 5 best): 4-5 <i>EN ISO 12945/2:2000; Método martindale modificado (2000 y 7000 ciclos)</i> (Escala de valores de 1 peor a 5 mejor): 4-5</p> <p><b>Assessment of ignitability / Reacción al fuego</b> BS 5852 Source 0 BS 5852 Source 1 EN 1021- Part 1:2006 EN 1021- Part 2:2006 CAL TB 117:2013 California NFPA 260:2013 BS 7176 Low Hazard UNI 9175 Clase 3IM IMO Anexo 1 Parte 8</p> <p><b>Lightfastness / Solidez a la luz artificial</b> EN ISO 105-B02:1998 &amp; EN ISO 105 B02/A01:2002 Colour degradation on blue scale (Scale from 1 worst to 8 best): 7-8 <i>Degradación de color en la escala de azules (Escala de 1 peor a 8 mejor): 7-8</i> Colour fastness to rubbing (dry and wet) / Solidez al frote (seco y húmedo) EN ISO 105-X12:2002 (Scale from 1 worst to 5 best): 4-5 (Escala de valores de 1 peor a 5 mejor): 4-5</p> <p><b>Washing conditions / Condiciones de lavado</b>  </p>	<p>Beige – TF05 </p> <p>Dark Grey / Gris – TF53 </p> <p>Light Grey / Gris – TF54 </p> <p>Garnet / Granate – TF122 </p> <p>Mustard / Mostaza – TF125 </p> <p>Green / Verde – TF138 </p> <p>Blue / Azul – TF143 </p> <p>Antacite grey / Gris antracita – TF155 </p>

# BD FINISHES / ACABADOS

## FABRICS / TELAS













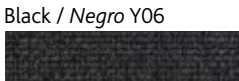
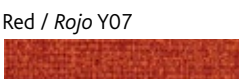

### COMPOSITION KEY / CLAVES DE COMPOSICIÓN

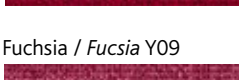
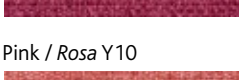
PES - POLYESTER / POLIÉSTER	WO - NATURAL WOOL / LANA NATURAL
PP - POLYPROPYLENE / POLIPROPILENO	CV - VISCOSE / VISCOSA
CO - COTTON / ALGODÓN	MA - MINERAL FIBRE / FIBRA MINERAL

REF	NAME / TIPOLOGÍA	DESCRIPTION / DESCRIPCIÓN	COLOURS / COLORES
CAT 4	<b>Moss</b> (recommended for contract use / recomendado para uso contract)	<p><b>Composition / Composición</b> 100%PES FR</p> <p><b>Abrasion resistance (End point) / Resistencia a la abrasión (Rotura hilos):</b> EN ISO 12947-2:1998 - 50.000</p> <p><b>Pilling resistance / Resistencia al pilling</b> EN ISO 12945/2:2000; Modified martindale method (2000 and 7000 cycles) (Scale from 1 worst to 5 best): 4-5 EN ISO 12945/2:2000; Método martindale modificado (2000 y 7000 ciclos) (Escala de valores de 1 peor a 5 mejor): 4-5</p> <p><b>Assessment of ignitability / Reacción al fuego</b> BS 5852 Source 0 BS 5852 Source 1 EN 1021- Part 1:2006 EN 1021- Part 2:2006 CAL TB 117:2013 California NFPA 260:2013 BS 7176 Low Hazard UNI 9175 Clase 1IM IMO Anexo 1 Parte 8 NF D 60 013 DIN 4102 B2</p> <p><b>Acoustic certificate</b> -EN ISO 354</p> <p><b>Lightfastness / Solidez a la luz artificial</b> EN ISO 105-B02:1998 &amp; EN ISO 105 B02/A01:2002 Colour degradation on blue scale (Scale from 1 worst to 8 best): 6-7 Degradación de color en la escala de azules (Escala de 1 peor a 5 mejor): 6-7</p> <p><b>Colour fastness to rubbing / Solidez al frote</b> EN ISO 105-X12:2002 (Scale from 1 worst to 5 best) Dry: 5; Wet: 4-5 EN ISO 105-X12:2002 (Escala de valores de 1 peor a 5 mejor) Seco: 4; Húmedo: 4-5</p> <p><b>Washing conditions / Condiciones de lavado</b></p> 	<p>Orange Brown / Marrón naranja – TM24</p>  <p>Blue / Azul – TM45</p>  <p>Dark Grey / Gris oscuro – TM53</p>  <p>Red / Rojo – TM65</p> 

# BD FINISHES / ACABADOS

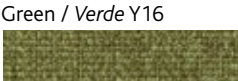
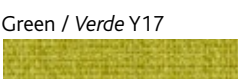
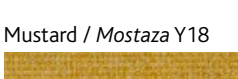
## FABRICS / TELAS



REF	NAME / TIPOLOGÍA	DESCRIPTION / DESCRIPCIÓN	COLOURS / COLORES	
Y	<b>Medley</b> <b>Gabriel</b>	<p><b>Composition / Composición</b> 100% polyester <b>Weight / Peso:</b> 510 g / ml <b>Width / Ancho:</b> 140 cm</p> <p><b>Abrasion resistance / Resistencia a la abrasión</b> 75,000 rubs martindale (EN ISO 12947-2) <b>Piling:</b> 4 scale 1-5, max. 5 - EN ISO 12945-2</p> <p><b>Colour fastness to light / Solidez del color a la luz</b> 5-7 scale 1-8, max. 8 - EN ISO 105-B02</p> <p><b>Colour fastness to rubbing / Solidez del color al frote</b> 4-5/4-5 scale 1-5, max. 5 - EN ISO 105x12 (wet/dry)</p> <p><b>Cleaning / Limpieza:</b> Dry cleaning P(W)</p> <p><b>Flammability / Tratamiento ignifugo</b> BS EN 1021 1&amp;2 BS EN 1021-1 cigarette BS 5852 Part 1 0,1 Cigarette &amp; match BS 476 Part 7, class 2 Class Uno UNI 9175 Class 1   EMME ÖNORM B 3825-B2-3800-Q1 UK CAT B 117-2013 ASTM E 84</p> <p><b>Maintenance</b> Dry cleaning. Medley is made of polyester which is a material suited for environments with special cleaning requirements. In case of stains, use a damp cloth with neutral soap suitable for cleaning upholstery.</p> <p><b>Mantenimiento</b> <i>Limpieza en seco. Medley está hecho de poliéster, que es un material adecuado para entornos con requisitos especiales de limpieza. En caso de manchas, use un paño húmedo con jabón neutro adecuado para limpiar la tapicería.</i></p>	<p>Beige / Beige Y01 </p> <p>Grey / Gris Y02 </p> <p>Grey / Gris Y03 </p> <p>Brown / Marrón Y04 </p> <p>Brown / Marrón Y05 </p> <p>Black / Negro Y06 </p> <p>Red / Rojo Y07 </p> <p>Garnet / Granate Y08 </p> <p>Fuchsia / Fucsia Y09 </p> <p>Pink / Rosa Y10 </p>	<p>Pink / Rosa Y11 </p> <p>Blue / Azul Y12 </p> <p>Dark blue / Azul marino Y13 </p> <p>Blue / Azul Y14 </p> <p>Turquoise / Turquesa Y15 </p> <p>Green / Verde Y16 </p> <p>Green / Verde Y17 </p> <p>Mustard / Mostaza Y18 </p> <p>Pistachio / Pistacho Y19 </p>

# BD FINISHES / ACABADOS

## FABRICS / TELAS













### COMPOSITION KEY / CLAVES DE COMPOSICIÓN

PES - POLYESTER / POLIÉSTER	WO - NATURAL WOOL / LANA NATURAL
PP - POLYPROPYLENE / POLIPROPILENO	CV - VISCOSE / VISCOSA
CO - COTTON / ALGODÓN	MA - MINERAL FIBRE / FIBRA MINERAL

REF	NAME / TIPOLOGÍA	DESCRIPTION / DESCRIPCIÓN	COLOURS / COLORES
G	Gamma	<p><b>Composition / Composición</b> 100% PP, outdoor use / uso exterior</p> <p><b>Weight / Ancho:</b> 200g/mq</p> <p><b>Tear resistance / Resistencia del desgarro</b> 40.000 Martindale (UNE EN ISO 12947-1)</p> <p><b>Colour fastness / Solidez de color</b> 8-8 (UNI EN 180 105B02)</p> <p><b>Cleaning / Limpieza</b> Dry clean / <i>Nettoyage à sec</i> Lavaggio a secco / <i>Chemische Reinigung</i></p> <p><b>UV protection / Protección UV (0-50):</b> 50+</p> <p><b>Fire test / Tratamiento ignífugo</b> UE: EN 1021 - 1 :2006 UK: BS 5852 - 2006 D: DIN 66084 : 2003 clasification P-c USA: CALTB 117 : 2000 Section E NFPA 260 : 2009 Class 1</p> <p><b>Colour matching / Semejanza de colores</b> Colour variations between batches (3%) <i>Variaciones de color entre lotes (3%)</i></p> <p><b>Maintenance / Mantenimiento</b> Vacuum regularly. In case of stains, use a damp cloth with neutral soap suitable for cleaning upholstery. <i>Aspirar regularmente. En caso de manchas, use un paño húmedo con jabón neutro adecuado para limpiar la tapicería.</i></p>	<p>White / Blanco – G04</p>  <p>Grey / Gris – G13</p>  <p>Green / Verde – G16</p> 

## BD FINISHES / ACABADOS

### WOOD / MADERA

REF	NAME / TIPOLOGÍA	DESCRIPTION / DESCRIPCIÓN	COLOURS / COLORES
RM	<b>Varnished Oak / Roble barnizado</b>	Stained oak and varnished. <i>Roble teñido y barnizado</i>	
RMW	<b>Natural waxed Oak / Roble encerado natural</b>	Oak wood with natural wax <i>Madera de roble encerado natural</i>	
NGEN	<b>Walnut / Nogal</b>	Walnut Nature Effect <i>Nogal Efecto Nature</i>	
FR	<b>Ash / Fresno</b>	Natural varnished <i>Natural barnizado</i>	
FR10		Open pore lacquered in black <i>Lacado a poro abierto en negro</i>	
FR20		Open pore lacquered in coral red <i>Lacado a poro abierto en rojo coral</i> (RAL 3016)	
FT10		Stained Black <i>Teñido negro</i>	
FT18		Stained Oak <i>Teñido Roble</i>	
ES	<b>Laminated Estratificado</b>	Grey perle <i>Gris perla</i>	
		Sable <i>Arena</i>	
		Nearly Black <i>Casi negro</i>	
		Natural oak <i>Roble natural</i>	

## BD FINISHES / ACABADOS

REF	NAME / TIPOLOGÍA	DESCRIPTION / DESCRIPCIÓN	COLOURS / COLORES
LAC	<b>High Gloss lacquer</b> <i>Lacado brillo</i>		White / Blanco – 04 (RAL 9003)    White / Blanco – B31 (RAL 9016)   Black / Negro – 10 (RAL 9005)    Green / Verde - B33 (RAL 6021)   Blue / Azul – 09 (RAL 5002)    Blue / Azul – B32 (RAL 5011)  
LAC	<b>Matte lacquer</b> <i>Lacado mate</i>		White / Blanco – M04 (RAL 9003)    Dark Blue / Azul oscuro – M17 (RAL 5003)   Black / Negro – M10 (RAL 9005)    Blue / Azul – 09 (RAL 5002)   Dark red / Rojo oscuro – M19 (RAL 3004) 

### WOOD & LACQUER MAINTENANCE AND CLEANING / MANTENIMIENTO Y LIMPIEZA DE LA MADERA Y LA LACA

Furniture pieces should be placed in areas with stable temperatures and humidity. Only suitable for indoor use. It is recommended that items be placed in areas with no direct exposure to air conditioners, heat or sunlight.

Rub gently with a dry cotton cloth or with a natural wax product. Solvents and abrasive detergents should especially be avoided.

#### Maintenance and cleaning

BD recommends using a damp cloth using only water. For oily, greasy stains (finger prints) we recommend using a sponge with water and a neutral detergent, and afterwards finishing off with a water dampened cloth. Using detergents containing solvents and or pure ethyl alcohol should be avoided.

*As these are natural colours and tones, there may be some differences. Clear woods always tend to darken with time but this also depends on the direct exposure to light.*

*Los muebles deben colocarse en áreas con temperatura y humedad estables. Sólo apto para uso en interiores. Se recomienda evitar la exposición directa a los aires acondicionados, el calor directo o la luz solar.*

*Frote suavemente con un paño seco de algodón o con un producto de cera natural. No utilice disolventes ni productos abrasivos.*

#### Mantenimiento y Limpieza

BD recomienda utilizar un trapo humedecido con agua. Para manchas grasientas/untuoso (huellas), se aconseja pasar una esponja con agua y detergente neutro y luego con un paño humedecido con agua. Se debe evitar la utilización de detergente que contengan solventes y/o alcohol etílico puro.

*Al tratarse de colores y tonos naturales, pueden haber algunas diferencias. Las maderas claras con el tiempo tienden siempre a oscurecer, dependiendo de la exposición directa de la luz.*



## BD FINISHES / ACABADOS

---

### PLASTIC / PLÁSTICO

REF      NAME / TIPOLOGÍA      COLOURS / COLORES

---

PL      Polypropylene  
Polipropileno



White / Blanco



Red / Rojo



### PLASTIC MAINTENANCE AND CLEANING / MANTENIMIENTO Y LIMPIEZA DEL PLÁSTICO

BD recommends using a damp cloth using only water. For oily, greasy stains (finger prints) we recommend using a sponge with water and a neutral detergent, and afterwards finishing off with a water dampened cloth. Using detergents containing solvents and or pure ethyl alcohol should be avoided.

*BD aconseja un trapo humedecido con agua. Para manchas grasientas/untuoso (huellas), se aconseja pasar una esponja con agua y detergente neutro y luego con un paño humedecido con agua. Se debe evitar la utilización de detergente que contengan solventes y/o alcohol etílico puro.*

### MARBLE / MÁRMOL

---

White / Blanco Carrara Venato



Black / Negro Nero Marquina



Green / Verde Patrizia



### MARBLE MAINTENANCE AND CLEANING / MANTENIMIENTO Y LIMPIEZA DEL MÁRMOL

BD recommends using a damp cloth using only lukewarm water. For oily, greasy stains (finger prints) we recommend using a sponge with water and a neutral detergent, and afterwards finishing off with a water dampened cloth. Using detergents containing solvents and or pure ethyl alcohol should be avoided.

*BD recomienda utilizar un paño mojado con agua tibia. En caso de manchas, provocadas por líquidos y/o sustancias untuosas, en seguida hay que extraer/sacar lo sucio con un paño que absorba y luego, pasar toda la superficie con un paño mojado en agua tibia. Hay que evitar específicamente disolventes y detergentes abrasivos.*

## GLIDES FOR CHAIRS & ARMCHAIRS / TACOS PARA SILLAS Y BUTACAS

**SHOWTIME & NUDE  
4 LEGS / PATAS  
WOOD  
MADERA**

**QUICKCLICK SYNO**  
(included / incluido)

Novel, natural special fibre mixture; abrasion proof, humidity repellent and sound dampening. E.g.: linoleum, ceramic, terrazzo.

*Mezcla natural de fibra especial; a prueba de abrasión, repelente de humedad y amortiguación acústica.  
Por ejemplo: linóleo, cerámica, terrazo.*



**SHOWTIME & NUDE  
SWIVEL / GIRATORIA**

**STANDARD**  
(included / incluido)

Polyethylene lightweight rounded insert; for hard and semi-hard surfaces. E.g.: Concrete, ceramic, wood.

*Taco redondo ligero de polietileno; para superficies duras y semiduras.  
Por ejemplo: hormigón, cerámica, madera.*



**QUICKCLICK ULTRASOFT**  
(included / incluido)

High quality pressed wool felt glide for highly sensitive hard floorings. E.g.: Wood.

*Taco de fieltro de lana prensada de alta calidad para suelos duros altamente sensibles.  
Por ejemplo: madera.*



**QUICKCLICK SUPER**  
(special order only / bajo pedido)

From high technical POM plastic; very good sliding properties; for all soft surfaces. E.g.: Carpet.

Valid until stock lasts.

*De plástico de alta técnica POM; muy buenas propiedades deslizantes; para todas las superficies blandas.  
Por ejemplo: alfombra.  
Válido hasta agotar existencias.*



**SHOWTIME & NUDE  
4 LEGS / PATAS  
METAL**

**QUICKCLICK SUPER**  
(included / incluido)

From high technical POM plastic; very good sliding properties; for all soft surfaces. E.g.: Carpet.

*De plástico de alta técnica POM; muy buenas propiedades deslizantes; para todas las superficies blandas.  
Por ejemplo: alfombra.*



**QUICKCLICK SYNO**  
(special order only / bajo pedido)

Novel, natural special fibre mixture; abrasion proof, humidity repellent and sound dampening. E.g.: linoleum, ceramic, terrazzo.

*Mezcla natural de fibra especial; a prueba de abrasión, repelente de humedad y amortiguación acústica.  
Por ejemplo: linóleo, cerámica, terrazo.*



**QUICKCLICK ULTRASOFT**  
(included / incluido)

High quality pressed wool felt glide for highly sensitive hard floorings. E.g.: Wood.

*Taco de fieltro de lana prensada de alta calidad para suelos duros altamente sensibles.  
Por ejemplo: madera.*



**QUICKCLICK ULTRASOFT**  
(special order only / bajo pedido)

High quality pressed wool felt glide for highly sensitive hard floorings. E.g.: Wood flooring only.

*Taco de fieltro de lana prensada de alta calidad para suelos duros altamente sensibles.  
Por ejemplo: solo suelos madera.*

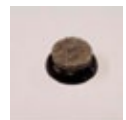

**SHOWTIME & NUDE  
SLED / PATÍN**

**STANDARD**  
(included / incluido)

Polyethylene lightweight insert; for hard and semi-hard surfaces. E.g.: Concrete, ceramic, wood.

*Taco redondo ligero de polietileno; para superficies duras y semiduras.  
Por ejemplo: hormigón, cerámica, madera.*



**GAULINO GAULINETTA  
CHAIR & ARMCHAIR  
SILLA Y  
CHAIR B**

**QUICKCLICK SYNO**  
(included / incluido)

Novel, natural special fibre mixture; abrasion proof, humidity repellent and sound dampening. E.g.: linoleum, ceramic, terrazzo.

*Mezcla natural de fibra especial; a prueba de abrasión, repelente de humedad y amortiguación acústica.  
Por ejemplo: linóleo, cerámica, terrazo.*



**QUICKCLICK ULTRASOFT**  
(included on request / incluido bajo pedido)

High quality pressed wool felt glide for highly sensitive hard floorings. E.g.: Wood.

*Taco de fieltro de lana prensada de alta calidad para suelos duros altamente sensibles.  
Por ejemplo: madera.*



**QUICKCLICK ULTRASOFT**  
(included / incluido)

High quality pressed wool felt glide for highly sensitive hard floorings. E.g.: Wood.

*Taco de fieltro de lana prensada de alta calidad para suelos duros altamente sensibles.  
Por ejemplo: madera.*

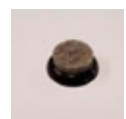

**QUICKCLICK SYNO**  
(special order only / bajo pedido)

Novel, natural special fibre mixture; abrasion proof, humidity repellent and sound dampening. E.g.: linoleum, ceramic, terrazzo.

*Mezcla natural de fibra especial; a prueba de abrasión, repelente de humedad y amortiguación acústica.  
Por ejemplo: linóleo, cerámica, terrazo.*



**MINIVARIUS**











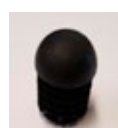

**STANDARD**  
(included / incluido)

Polyethylene lightweight rounded insert; for hard and semi-hard surfaces. E.g.: Concrete, ceramic, wood.

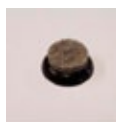
*Taco redondo ligero de polietileno; para superficies duras y semiduras.  
Por ejemplo: hormigón, cerámica, madera.*



## GLIDES FOR CHAIRS & ARMCHAIRS / TACOS PARA SILLAS Y BUTACAS

<p><b>JAMAICA STOOL TABURETE</b></p>	<p><b>STANDARD</b> (included / incluido)</p> <p>Polyethylene lightweight rounded insert; for hard and semi-hard surfaces. E.g.: Concrete, ceramic, wood.</p> <p><i>Taco redondo ligero de polietileno; para superficies duras y semiduras. Por ejemplo: hormigón, cerámica, madera.</i></p>		<p><b>JANET STOOL TABURETE</b></p>	<p><b>STANDARD</b> (included / incluido)</p> <p>Polyethylene lightweight rounded insert; for hard and semi-hard surfaces. E.g.: Concrete, ceramic, wood.</p> <p><i>Taco redondo ligero de polietileno; para superficies duras y semiduras. Por ejemplo: hormigón, cerámica, madera.</i></p>	
<p><b>GRASSO STOOL TABURETE</b></p>	<p><b>STANDARD</b> (included / incluido)</p> <p>Rubber semispherical non-slipping insert; for standard floorings. E.g.: Concrete, ceramic, wood.</p> <p><i>Taco antideslizante semiesférico de goma; para pavimentos estándar. Por ejemplo: hormigón, cerámica, madera.</i></p>		<p><b>POLTRONA SHOWTIME</b></p>	<p><b>STOP</b> (included / incluido)</p> <p>The safety insert with the stop effect for all smooth, slippery surfaces. E.g.: Marble, ceramic tiles, natural stone, wooden floors.</p> <p><i>Taco de seguridad con efecto de parada para todas las superficies lisas y resbaladizas. Por ejemplo: mármol, baldosas de cerámica, piedra natural, suelos de madera.</i></p>	
<p><b>GRASSO ARMCHAIR BUTACA</b></p>	<p><b>STANDARD</b> (included / incluido)</p> <p>Rubber semispherical non-slipping insert. For standard floorings. E.g.: Concrete, ceramic, wood.</p> <p><i>Taco antideslizante semiesférico de goma; para pavimentos estándar. Por ejemplo: hormigón, cerámica, madera.</i></p>		<p><b>DINO</b></p>	<p><b>QUICKCLICK ULTRASOFT</b> (included for iron standard legs / incluido para patas de hierro standard)</p> <p>High quality pressed wool felt glide for highly sensitive hard floorings. E.g.: Wood.</p> <p><i>Taco de fieltro de lana prensada de alta calidad para suelos duros altamente sensibles. Por ejemplo: madera.</i></p>	
<p><b>COUTURE / LITTLE COUTURE</b></p>	<p><b>QUICKCLICK ULTRASOFT</b> (included for fixed base model / incluido para el modelo con base fija)</p> <p>High quality pressed wool felt glide for highly sensitive hard floorings. E.g.: Wood.</p> <p><i>Taco de fieltro de lana prensada de alta calidad para suelos duros altamente sensibles. Por ejemplo: madera.</i></p>		<p><b>QUICKCLICK ULTRASOFT</b> (included for aluminium legs / incluido para patas de aluminio)</p> <p>High quality pressed wool felt glide for highly sensitive hard floorings. E.g.: Wood.</p> <p><i>Taco de fieltro de lana prensada de alta calidad para suelos duros altamente sensibles. Por ejemplo: madera.</i></p>		
<p><b>LOUNGER &amp; LOW LOUNGER</b></p>	<p><b>QUICKCLICK ULTRASOFT</b> (included for swivel system model / incluido para el modelo con sistema giratorio)</p> <p>High quality pressed wool felt glide for highly sensitive hard floorings. E.g.: Wood.</p> <p><i>Taco de fieltro de lana prensada de alta calidad para suelos duros altamente sensibles. Por ejemplo: madera.</i></p>		<p><b>QUICKCLICK SYNO</b> (included for aluminium legs / incluido para patas de aluminio)</p> <p>Novel, natural special fibre mixture; abrasion proof, humidity repellent and sound dampening. E.g.: linoleum, ceramic, terrazzo.</p> <p><i>Mezcla natural de fibra especial; a prueba de abrasión, repelente de humedad y amortiguación acústica. Por ejemplo: linóleo, cerámica, terrazo.</i></p>		
<p><b>LOUNGER &amp; LOW LOUNGER</b></p>	<p><b>STANDARD</b> (included / incluido)</p> <p>Polyethylene lightweight rounded insert; for hard and semi-hard surfaces. E.g.: Concrete, ceramic, wood.</p> <p><i>Taco redondo ligero de polietileno; para superficies duras y semiduras. Por ejemplo: hormigón, cerámica, madera.</i></p>		<p><b>GARDENIAS</b></p>	<p><b>STANDARD</b> (included / incluido)</p> <p>Polyethylene lightweight glide with rounded insert; for hard and semi-hard surfaces. E.g.: Concrete, ceramic, wood.</p> <p><i>Taco ligero de polietileno con inserción redondeada; para superficies duras y semiduras. Por ejemplo: hormigón, cerámica, madera.</i></p>	
<p><b>LOW LOUNGER 4 LEG 4 PATAS</b></p>	<p><b>STANDARD</b> (included / incluido)</p> <p>Polyethylene lightweight rounded insert; for hard and semi-hard surfaces. E.g.: Concrete, ceramic, wood.</p> <p><i>Taco redondo ligero de polietileno; para superficies duras y semiduras. Por ejemplo: hormigón, cerámica, madera.</i></p>		<p><b>STANDARD</b> (included / incluido)</p> <p>Polyethylene lightweight rounded insert; for hard and semi-hard surfaces. E.g.: Concrete, ceramic, wood.</p> <p><i>Taco redondo ligero de polietileno; para superficies duras y semiduras. Por ejemplo: hormigón, cerámica, madera.</i></p>		

# SHELVING / CONTENEDORES

## DREAMS CABINET

Cristian Zuzunaga

Modules, doors, shelves and drawers lacquered in a matte black finish. Tops, doors and sides mounted with 6mm tempered printed glass.  
Legs: Solid beech wood lacquered in matte black. Available in 4 versions: colour, white, black and All Black. Shelves included.

*Contenedores, puertas, estantes y cajones lacados en negro mate. Tops superiores, frontales y laterales en vidrio templado impreso de 6mm. Patas en haya maciza lacadas negro mate. 4 versiones: color, blanco, negro y All Black. Estantes incluidos.*

### 2M

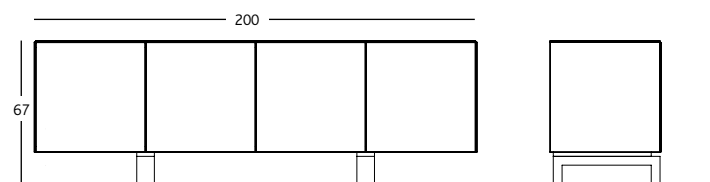

**2M** 7.253  
(includes 4 shelves / incluye 4 estantes)

**3M** 11.036  
(includes 6 shelves / incluye 6 estantes)

**Single drawer** 670  
**Cajón individual**

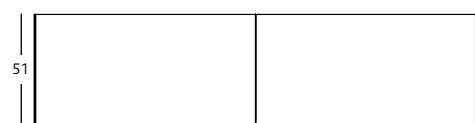

### 3M

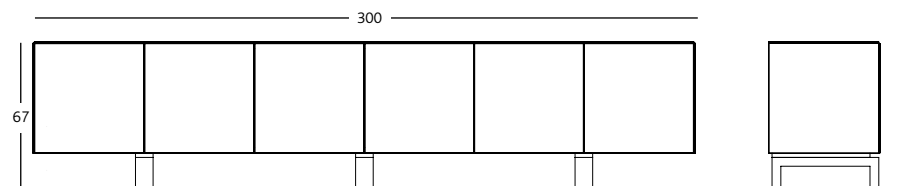

### Single drawer (optional) Cajón individual (opcional)

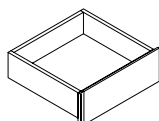
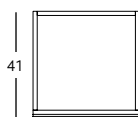
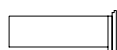
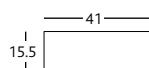

#### PACKAGING

Module 1M / Módulo 1M (without drawers / sin cajones)	PCS	DIMENSIONS CM	GROSS KG
	1	115 x 60 x 72	86



MODELS / MODELOS

Colour / Color



White / Blanco

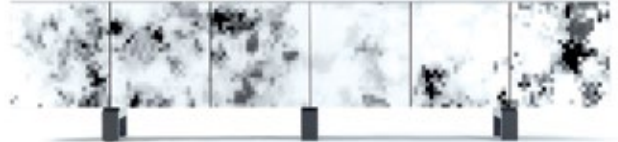

Black / Negro



All Black



TABLES  
MESAS

ARMCHAIRS  
BUTACAS

EXAMPLES / EJEMPLOS

Example / Ejemplo 1

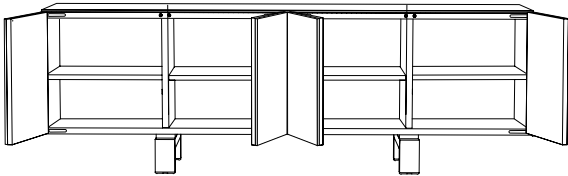

2M (4 shelves / estantes)

TOTAL 7.253

PACKAGING

PCS	DIMENSIONS CM	GROSS KG
2	115 x 60 x 72	172

CHAIRS AND STOOLS  
SILLAS Y TABURETES

ACCESSORIES  
ACCESORIOS

Example / Ejemplo 2

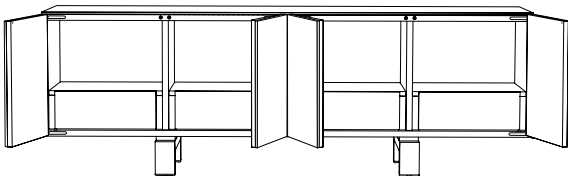

2M (4 drawers / cajones)

TOTAL 9.933

PACKAGING

PCS	DIMENSIONS CM	GROSS KG
2	115 x 60 x 72	188

LIGHTING  
ILUMINACIÓN

Example / Ejemplo 3

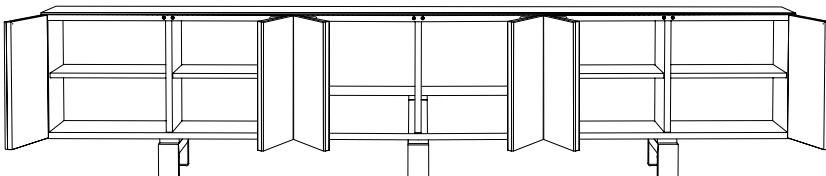

3M (4 shelves + 2 drawers / 4 estantes + 2 cajones)

TOTAL 12.376

PACKAGING

PCS	DIMENSIONS CM	GROSS KG
3	115 x 60 x 72	266

PUBLIC SEATING  
ASIENTOS PÚBLICOS

ART EDITIONS

## COUTURE CABINET

Färg & Blanche

Sideboard and shelves in ash stained black. Structure in anodic black lacquered steel. Doors sewn in blue thread.

Contenedor y estantes de tablero chapado en fresno teñido color negro. Estructura en acero pintado en anódico black. Puertas cosidas en hilo color azul.

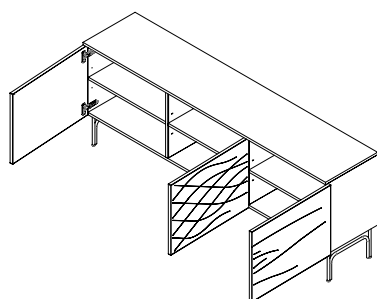
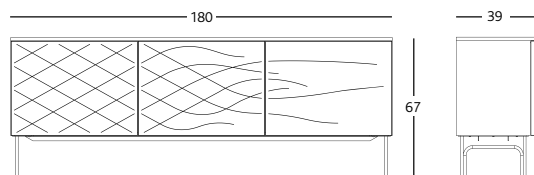

COUCAT10AZ      **Ash Stained black and blue thread**      4.181  
**Fresno teñido negro con hilo color azul**

PACKAGING			
Module / Módulo	PCS	DIMENSIONS CM	GROSS KG
	1	186 x 45 x 67	65

## AQUÁRIO CABINET

Campana Brothers

External panels and doors in blue glass, veneered in pine stained in grey (Oberflex). Legs in pine stained in grey. Interior shelves in blue glass. Steel tube interior structure in a dark grey painted finish.

Paneles exteriores y puertas en vidrio azul chapado en pino teñido gris (Oberflex). Patas en madera de pino teñido gris. Estantes interiores en vidrio azul. Estructura interior en tubo de acero pintado en gris oscuro.

Side 1 / Lateral 1

Front / Frontal

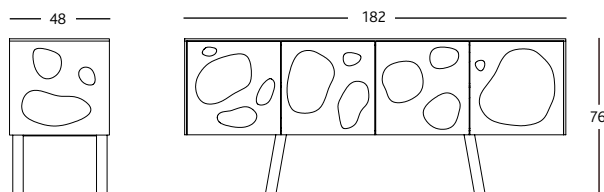

AQUCGRAZMODA      **Blue glass / Cristal azul**      10.854

Side 2 / Lateral 2

Back / Trasera

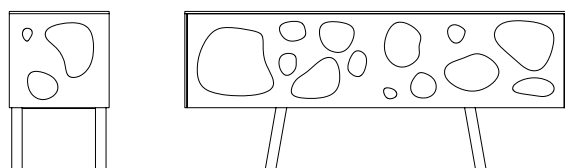

Top / Superior

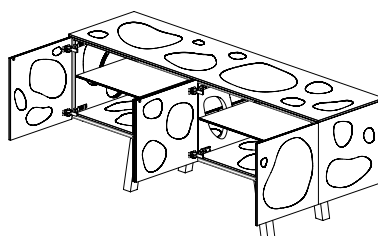
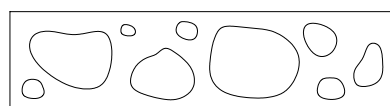

PACKAGING			
Module / Módulo	PCS	DIMENSIONS CM	GROSS KG
	1	200 x 65 x 80	166



## SHANTY CABINET

Doshi Levien

Modules in MDF fibreboard with a lacquered matte finish. Modules are joined together using a mechanical fixing system. Doors in MDF fibreboard with a mechanised waveform frontal and matte lacquered finish. 8mm painted glass top. Octagonal legs made of extruded anodised gold aluminium. Structure in tubular steel with welded strips to assemble legs. Steel structure painted in black or white satin polyester.

Contenedores en MDF lacados en mate. Fijados mediante sistema mecánico. Puertas fabricadas en MDF lacadas mate con frontales mecanizados en forma de onda. Vidrio pintado de 8mm. Patas octogonales fabricadas en aluminio extrusionado anodizado en dorado. Estructura de acero pintada en poliéster satinado negro o blanco.

## Shanty Small

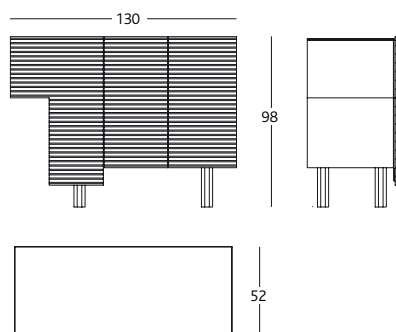
Summer / Winter  
Verano / Invierno

Shanty Small / Shanty pequeño 4.907

Model A: double folding door 7.948  
Modelo A: doble puerta abatibleModel B: folding door + drawers 9.047  
Modelo B: puerta abatible + cajones

## Model A

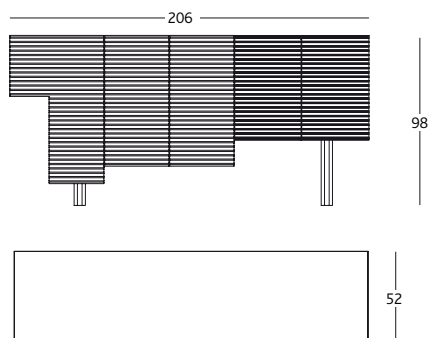

## Model B

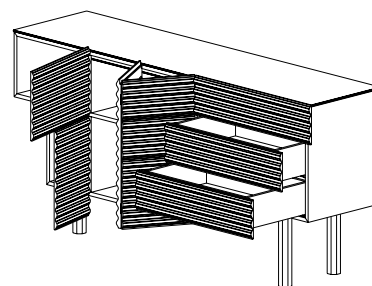
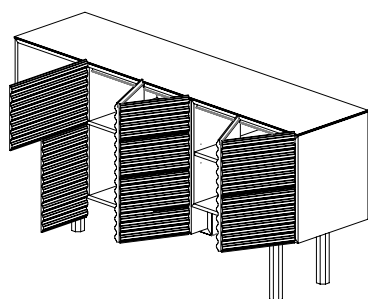
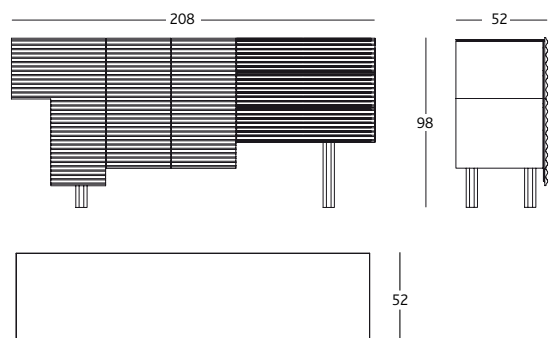
Summer: Multicolour  
Verano: MulticolorWinter: Grey & white  
Invierno: Gris y blanco

## PACKAGING

	PCS	DIMENSIONS CM	GROSS KG
Module / Módulo Model A	1	120 x 100 x 190	150
Module / Módulo Model B	1	120 x 100 x 190	166
Glass / Vidrio	1	215 x 50 x 70	45
Module Small / Módulo pequeño	1	135 x 80 x 85	112
Glass Small / Vidrio pequeño	1	160 x 50 x 70	44

# MULTILEG SHOWTIME CABINET

Jaime Hayon

Modules and doors in MDF and lacquered high-gloss, matte or veneered in varnished walnut nature effect. The interior finish is matte for the lacquered version and veneered for the walnut nature effect option. Legs in solid turned alder-wood, lacquered in high-gloss or matte or stained in a walnut colour. Drawers with metallic laterals with lengths of half a module, a module or a drawer with the bottle holder. The drawer handles and bottle holder finish are in a brass finish.

Tops: 1cm glass painted, MDF veneered walnut nature effect or 2cm thick marble.

Four finishes available:

Matte lacquered with glass top / Gloss lacquered with glass top / Gloss lacquered with marble top / Walnut nature effect with walnut top.

Contenedor y frontales en MDF lacado en mate o brillo, o chapado en nogal barnizado efecto nature. Interior siempre en laca mate o chapado en nogal barnizado efecto nature. Patas en aliso macizo torneado, lacado en mate o brillo, o teñido color nogal.

Cajones con lateral metálico individuales, dobles o con sistema de botellero. Los tiradores y el botellero son cobreados.









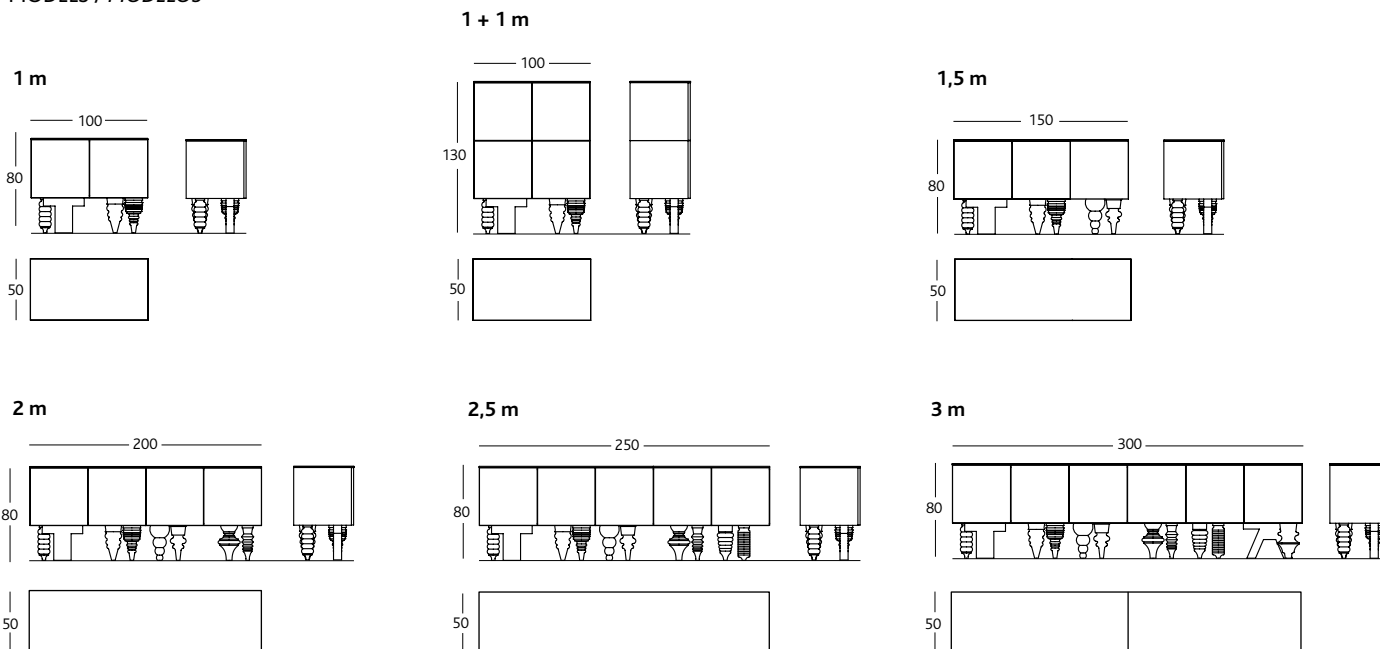



Sobres: vidrio de 1cm pintado, en MDF chapado en nogal barnizado efecto nature o en mármol de 2cm.

Cuarto opciones de acabado:

Laca mate con sobre vidrio / Laca brillo con sobre vidrio / Laca brillo con sobre mármol / Nogal barnizado efecto nature con sobre nogal.

## MODELS / MODELOS



TOPS / SOBRES	Glass	Walnut	Marble	LEGS / PATAS								
	Vidrio	Nogal	Mármol	Matte	Gloss	Walnut						
				Mate	Brillo	Nogal						
L. 1 m	485	298	898	Unit / Unidad						236	236	295
L. 1,5 m	724	404	1.147									
L. 2 m	965	543	1.620									
L. 2,5 m	1.220	708	2.224	n°1	n°2	n°3	n°4	n°5	n°6			
L. 3 m (only in walnut / solo en nogal)		814										
				n°7	n°8	n°9	n°10	n°11	n°12			



CONFIGURATION MODELS / MODELOS DE CONFIGURACIÓN

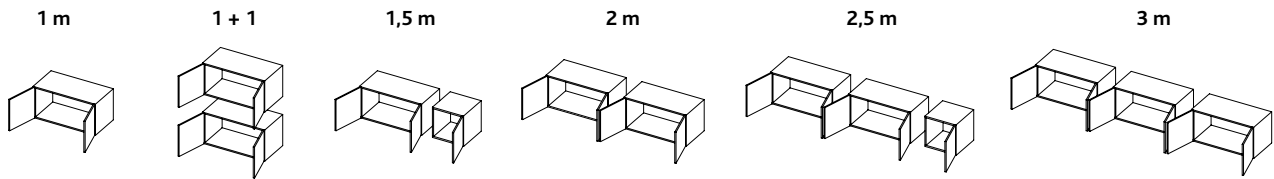

INTERIOR OPTION / OPCIÓN INTERIOR

Module / Módulo 1m			Matte Mate	High Gloss Brillo	Walnut Nogal
		1 A	2.051	2.112	2.369
		1 B Horizontal shelf / Estante horizontal	2.173	2.234	2.491
		1 C Double Drawer / Cajón doble	2.873	2.937	3.241
		1 D Double Drawer / Cajón doble	2.873	2.937	3.241
		2 A Vertical divider / División vertical	2.081	2.143	2.400
		2 B Shelf Right / Estante derecha	2.179	2.240	2.510
		2 C Shelf left / Estante izquierda	2.179	2.240	2.510
		2 D Vertical divider and shelves / División vertical y estantes	2.277	2.338	2.620
		2 E Single Drawer + Shelf Right / Cajón + Estante Derecho	3.079	3.144	3.505
		2 F Single Drawer + Shelf Left / Cajón + Estante Izquierdo	3.079	3.144	3.505
		2 G Single Drawer + Shelf Right / Cajón + Estante Derecho	3.079	3.144	3.505
		2 H Single Drawer + Shelf Left / Cajón + Estante Izquierdo	3.079	3.144	3.505
		2 I Shelf right + Bottle Drawer / Estante Derecho + botellero	3.460	3.525	3.860
		2 J Shelf Left + Bottle Drawer / Estante Izquierdo + botellero	3.460	3.525	3.860
		2 K Single Drawer + Bottle Drawer / Cajón + botellero	4.138	4.202	4.603
		2 L Single Drawer + Bottle Drawer / Cajón + botellero	4.138	4.202	4.603
		2 M Shelf Right + 3 Drawers Left / Estante Der. + 3 cajones Izq.	4.332	4.396	4.874
		2 N Shelf Left + 3 Drawers Right / Estante Izq. + 3 cajones Der.	4.332	4.396	4.874
Module / Módulo 0,5m			Matte Mate	High Gloss Brillo	Walnut Nogal
		3 A	1.377	1.408	1.561
		3 B Horizontal Half / Mitad horizontal	1.475	1.506	1.671
		3 C Single Drawer / Cajón individual	2.130	2.163	2.388
		3 D Single Drawer / Cajón individual	2.130	2.163	2.388
		3 E Bottle Drawer / Botellero	2.130	2.163	2.388
		3 F 3 Drawers / Cajones	3.486	3.518	3.873

## EXAMPLES / EJEMPLOS MULTILEG CABINET

### Example / Ejemplo 1 (1 m)

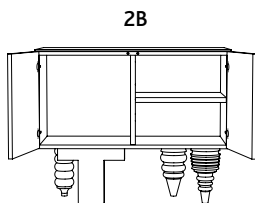

PACKAGING			
	PCS	DIMENSIONS CM	GROSS KG
Glass top + module + legs / Sobre vidrio + módulo + patas	1	120 x 80 x 110	116
Walnut top + module + legs / Sobre nogal + módulo + patas	1	120 x 80 x 110	109
Marble top + module + legs / Sobre mármol + módulo + patas	1	120 x 80 x 110	133

		Matte Mate	High Gloss Brillante	Walnut Nogal	High Gloss Brillante
TOP / SOBRE		Glass Vidrio	Glass Vidrio	Walnut Nogal	Marble Mármol
Module 2B	1 un	2.179	2.240	2.510	2.240
Top / sobre 1m	1 un	485	485	298	898
Legs / patas	4 un	944	944	1.180	944
<b>TOTAL</b>		<b>3.608</b>	<b>3.669</b>	<b>3.988</b>	<b>4.082</b>

### Example / Ejemplo 2 (1 + 1 m)

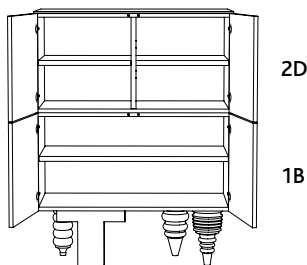

PACKAGING			
	PCS	DIMENSIONS CM	GROSS KG
Glass top + modules + legs / Sobre vidrio + módulos + patas	1	120 x 80 x 159	175
Walnut top + modules + legs / Sobre nogal + módulos + patas	1	120 x 80 x 159	168
Marble top + modules + legs / Sobre mármol + módulos + patas	1	120 x 80 x 159	192

		Matte Mate	High Gloss Brillante	Walnut Nogal	High Gloss Brillante
TOP / SOBRE		Glass Vidrio	Glass Vidrio	Walnut Nogal	Marble Mármol
Module 2D		2.277	2.338	2.620	2.338
Module 1B		2.173	2.234	2.491	2.234
Top / sobre 1m		485	485	298	898
Legs / patas		944	944	1.180	944
<b>TOTAL</b>		<b>5.879</b>	<b>6.001</b>	<b>6.589</b>	<b>6.414</b>

\*All vertically mounted double modules should always be fixed to the wall  
 Todos los módulos dobles montados verticalmente deben fijarse siempre a la pared.

### Example / Ejemplo 3 (1,5 m)

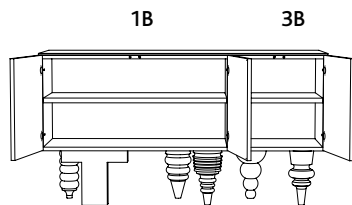

PACKAGING			
	PCS	DIMENSIONS CM	GROSS KG
Glass top / Sobre vidrio	1	165 x 50 x 72	44
Walnut top / Sobre nogal	1	165 x 50 x 72	31
Marble top / Sobre mármol	1	165 x 50 x 72	65
Modules + 6 legs / Módulos + 6 patas	1	120 x 80 x 130	120

		Matte Mate	High Gloss Brillante	Walnut Nogal	High Gloss Brillante
TOP / SOBRE		Glass Vidrio	Glass Vidrio	Walnut Nogal	Marble Mármol
Module 1B		2.173	2.234	2.491	2.234
Module 3B		1.475	1.506	1.671	1.506
Top / sobre 1,5m		724	724	404	1.147
Legs / patas		1.416	1.416	1.770	1.416
<b>TOTAL</b>		<b>5.788</b>	<b>5.880</b>	<b>6.336</b>	<b>6.303</b>

## EXAMPLES / EJEMPLOS MULTILEG CABINET

## Example / Ejemplo 4 (2 m)

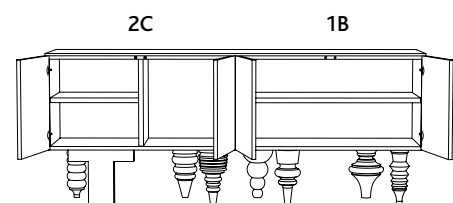

PACKAGING			
	PCS	DIMENSIONS CM	GROSS KG
Glass top / Sobre vidrio	1	212 x 50 x 72	58
Walnut top / Sobre nogal	1	212 x 50 x 72	42
Marble top / Sobre mármol	1	212 x 50 x 72	90
Modules + 8 legs / Módulos + 8 patas	1	120 x 80 x 165	151

## Example / Ejemplo 5 (2,5 m)

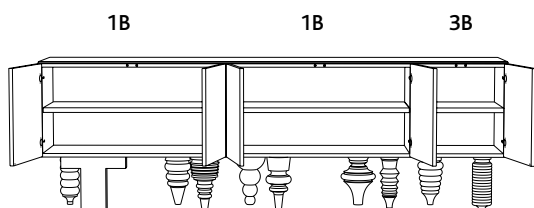

PACKAGING			
	PCS	DIMENSIONS CM	GROSS KG
Glass top / Sobre vidrio	1	262 x 50 x 72	88
Walnut top / Sobre nogal	1	262 x 50 x 72	62
Marble top / Sobre mármol	1	262 x 50 x 72	130
Modules 1B / Módulos 1B	1	120 x 80 x 190	135
Module 3B + 10 legs / Módulo 3B+ 10 patas	1	60 x 40 x 102	60

## Example / Ejemplo 6 (3 m)

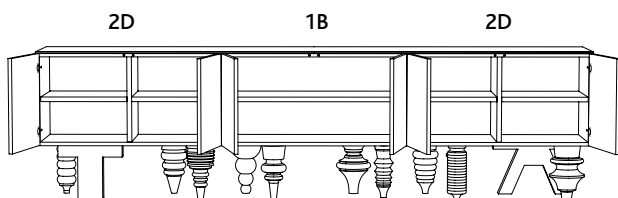

PACKAGING			
	PCS	DIMENSIONS CM	GROSS KG
Glass top / Sobre vidrio	2	163 x 50 x 72	44
Walnut top / Sobre nogal	1	312 x 50 x 72	62
Marble top / Sobre mármol	2	163 x 50 x 72	65
Module 1B + 12 legs / Módulo 1B + 12 patas	1	120 x 80 x 120	104
Modules 2D / Módulos 2D	1	120 x 80 x 130	151

Matte  
Mate

High Gloss  
Brillante

Walnut  
Nogal

High Gloss  
Brillante

TOP / SOBRE		Glass Vidrio	Glass Vidrio	Walnut Nogal	Marble Mármol
Module 2C	1 un	2.179	2.240	2.510	2.240
Module 1B	1 un	2.173	2.234	2.491	2.234
Top / sobre 2m	1 un	965	965	543	1.620
Legs / patas	8 un	1.888	1.888	2.360	1.888
<b>TOTAL</b>		<b>7.205</b>	<b>7.327</b>	<b>7.904</b>	<b>7.982</b>

Matte  
Mate

High Gloss  
Brillante

Walnut  
Nogal

High Gloss  
Brillante

TOP / SOBRE		Glass Vidrio	Glass Vidrio	Walnut Nogal	Marble Mármol
Module 1B	2 un	4.346	4.468	4.982	4.468
Module 3B	1 un	1.475	1.506	1.671	1.506
Top / sobre 2,5m	1 un	1.220	1.220	708	2.224
Legs / patas	10 un	2.360	2.360	2.950	2.360
<b>TOTAL</b>		<b>9.401</b>	<b>9.554</b>	<b>10.311</b>	<b>10.558</b>

Matte  
Mate

High Gloss  
Brillante

Walnut  
Nogal

High Gloss  
Brillante

TOP / SOBRE		Glass Vidrio	Glass Vidrio	Walnut Nogal	Marble Mármol
Module 2D	2 un	4.554	4.676	5.240	4.676
Module 1B	1 un	2.173	2.234	2.491	2.234
Top / sobre 1,5m	2 un	1.448	1.448	814*	2.294
Legs / patas	12 un	2.832	2.832	3.540	2.832
<b>TOTAL</b>		<b>11.007</b>	<b>11.190</b>	<b>12.085</b>	<b>12.036</b>

\*Top / sobre 3m (1 un)

## EXAMPLES FULL EQUIPMENT / EJEMPLOS EQUIPO COMPLETO MULTILEG CABINET

### Example / Ejemplo 7 (2 m)

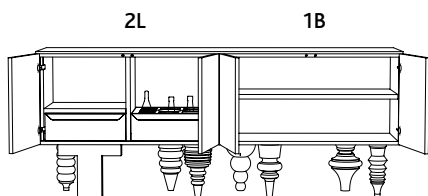

#### PACKAGING

	PCS	DIMENSIONS CM	GROSS KG
Glass top / Sobre vidrio	1	212 x 50 x 72	58
Walnut top / Sobre nogal	1	212 x 50 x 72	42
Marble top / Sobre mármol	1	212 x 50 x 72	90
Modules + 8 legs / Módulos + 8 patas	1	120 x 80 x 165	172

		Matte Mate	High Gloss Brillante	Walnut Nogal	High Gloss Brillante
<b>TOP / SOBRE</b>		Glass Vidrio	Glass Vidrio	Walnut Nogal	Marble Mármol
<b>Module 2L</b>	1 un	4.138	4.202	4.603	4.202
<b>Module 1B</b>	1 un	2.173	2.234	2.491	2.234
<b>Top / sobre 2m</b>	1 un	965	965	543	1.620
<b>Legs / patas</b>	8 un	1.888	1.888	2.360	1.888
<b>TOTAL</b>		9.164	9.289	9.997	9.944

### Example / Ejemplo 8 (2,5 m)

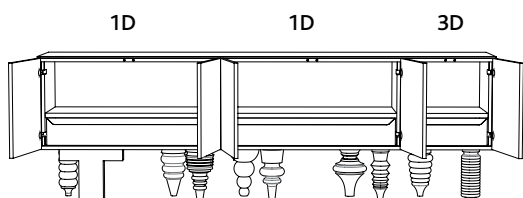

#### PACKAGING

	PCS	DIMENSIONS CM	GROSS KG
Glass top / Sobre vidrio	1	262 x 50 x 72	72
Walnut top / Sobre nogal	1	262 x 50 x 72	52
Marble top / Sobre mármol	1	262 x 50 x 72	110
Modules 1D / Módulos 1D	1	120 x 80 x 190	177
Module 3D + 10 legs / Módulo 3D + 10 patas	1	60 x 40 x 102	71

		Matte Mate	High Gloss Brillante	Walnut Nogal	High Gloss Brillante
<b>TOP / SOBRE</b>		Glass Vidrio	Glass Vidrio	Walnut Nogal	Marble Mármol
<b>Module 1D</b>	2 un	5.746	5.874	6.482	5.874
<b>Module 3D</b>	1 un	2.130	2.163	2.388	2.163
<b>Top / sobre 2,5m</b>	1 un	1.220	1.220	708	2.224
<b>Legs / patas</b>	10 un	2.360	2.360	2.950	2.360
<b>TOTAL</b>		11.456	11.617	12.528	12.621

### Example / Ejemplo 9 (3 m)

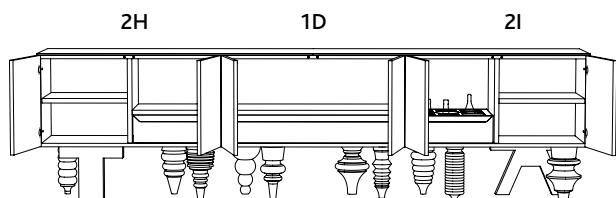

#### PACKAGING

	PCS	DIMENSIONS CM	GROSS KG
Glass top / Sobre vidrio	2	163 x 50 x 72	44
Walnut top / Sobre nogal	1	312 x 50 x 72	62
Marble top / Sobre mármol	2	163 x 50 x 72	65
Module 2I + 12 legs / Módulo 2I + 12 patas	1	120 x 80 x 120	114
Modules 2H + 1D / Módulos 2H + 1D	1	120 x 80 x 130	167

		Matte Mate	High Gloss Brillante	Walnut Nogal	High Gloss Brillante
<b>TOP / SOBRE</b>		Glass Vidrio	Glass Vidrio	Walnut Nogal	Marble Mármol
<b>Module 2H</b>	1 un	3.079	3.144	3.505	3.144
<b>Module 1D</b>	1 un	2.873	2.937	3.241	2.937
<b>Module 2I</b>	1 un	3.460	3.525	3.860	3.525
<b>Top / sobre 1,5m</b>	2 un	1.448	1.448	814*	2.294
<b>Legs / patas</b>	12 un	2.832	2.832	3.540	2.832
<b>TOTAL</b>		13.692	13.886	14.960	14.732

\*Top / sobre 3m (1 un)



MULTILEG SHOWTIME CABINET FINISHES / ACABADOS

LACQUERS / LACAS

<p><b>High Gloss lacquer</b> <i>Lacas brillo</i></p>	<p>LAC04 - White / <i>Blanco</i> RAL 9003 LAC09 - Blue / <i>Azul</i> RAL 5002 LAC10 - Black / <i>Negro</i> RAL 9005</p> <p>B31 - White/ <i>Blanco</i> RAL 9016 B32 - Blue / <i>Azul</i> RAL 5011 B33 - Green / <i>Verde</i> RAL 6021</p>
<p><b>Matte lacquer</b> <i>Laca mate</i></p>	<p>LACM04 - White / <i>Blanco</i> RAL 9003 LACM09 - Blue / <i>Azul</i> RAL 5002 LACM10 - Black / <i>Negro</i> RAL 9005</p>

MARBLE TOP / SOBRE MÁRMOL

<p><b>Marble tops</b> <i>Sobres mármol</i></p>	<p>Green / <i>Verde</i> Patrizia White / <i>Blanco</i> Carrara Venato Black / <i>Negro</i> Marquina</p>
--	---

WALNUT / NOGAL

<p><b>Walnut Nature</b> <i>Effect Nogal</i></p>	<p>NG EN</p>
---	--------------

- Special colours according to RAL chart.
- Custom colour + 10 % (minimum 2 boxes).
- *Colores especiales según carta RAL.*
- *Color cliente +10% (mínimo 2 cajas).*

## TOUT VA BIEN CABINET

Modules and shelves made of lacquered MDF in greyish white RAL 9002 or graphite grey RAL 7024. Doors, flat top(s), sides and leg AM04 are in injected integral polyurethane with a plywood support. Solid alder wooden legs in a microtextured lacquered finish (in the same colour as the piece).

*Contenedor y estante fabricado en MDF lacado en blanco grisáceo RAL 9002 o gris grafito RAL 7024. Puertas, sobre liso, laterales y pata AMØ4 en inyección de poliuretano integral, con soporte de tablero de melamina. Patas en aliso macizo de una sola pieza, lacada microtexturizado en el mismo color que las puertas.*

Module 60 / Módulo 60		Module 120 / Módulo 120		Legs / Patas				Optional drawers / Cajones opcionales	
AM 01	AM 02	AM 03	AM 04						
Top with mountain <i>Top con Montaña</i>	Flat top <i>Top liso</i>	Prism top <i>Top prisma</i>	Flat lateral <i>Lateral liso</i>	Prism lateral <i>Lateral prisma</i>	Left doors <i>Puertas izquierdas</i>	Right doors <i>Puertas derechas</i>			
	<b>Module 60</b> <small>(doors and shelves included / incluido puertas y estantes)</small> 60x50x60 cm	<b>Module 120</b> <small>(doors and shelves included / incluido puertas y estantes)</small> 120x50x60 cm	<b>Flat top or lateral</b> <i>Laterales o tops lisos</i>	<b>Prism top or lateral</b> <i>Top prisma o lateral</i>	<b>Top with mountain</b> <i>Top con montaña</i>	<b>Legs</b> <i>Patas</i>	<b>Lower drawer (un.)</b> <i>Cajón inferior (un.)</i>		
<b>Greyish White / Blanco grisáceo</b> RAL 9002	2.047	3.609	281	321	653	241	669		
<b>Graphite Gray / Gris Grafito</b> RAL 7024									

- Choose combination doors: right (R1 or R2) and left (L1 or L2).
- Each module has four legs.
- Leg AM 04 and the mountain top may have a different tone in colour due to the material (integral polyurethane).
- It is recommended not to place any objects on top of the top(s). Any damage caused will not be the responsibility of BD Barcelona.

- *Escoge puertas combinadas: derecha (R1 o R2) e izquierda (L1 o L2).*
- *Cada módulo tiene cuatro patas.*
- *El color de la pata AM 04 y el top de montaña puede tener diferente tonalidad debido al material empleado (poliuretano integral).*
- *Se recomienda no colocar ningún objeto encima de los top(s). Cualquier daño ocasionado no será responsabilidad de BD Barcelona.*

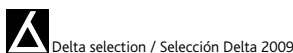

## EXAMPLES TOUT VA BIEN / EJEMPLOS TOUT VA BIEN

## Example / Ejemplo 1

TVBEJ01034 Greyish White / Blanco grisáceo  
TVBEJ01014 Graphite Grey / Gris grafito

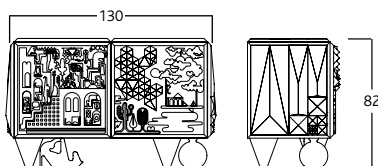

Module 120 Módulo 120	(1 unit x 3.609)	3.609
Legs Patas	(4 units x 241)	964
Prism lateral Lateral prisma	(2 units x 321)	642
Flat top Top liso	(2 units x 281)	562
<b>TOTAL</b>		<b>5.777</b>

## PACKAGING

Module / Módulo Legs / Patas	PCS	DIMENSIONS CM	GROSS KG
Module / Módulo	1	138 x 67 x 82	94
Legs / Patas	1	60 x 50 x 40	6

## Example / Ejemplo 2

TVBEJ02034 Greyish White / Blanco grisáceo  
TVBEJ02014 Graphite Grey / Gris grafito

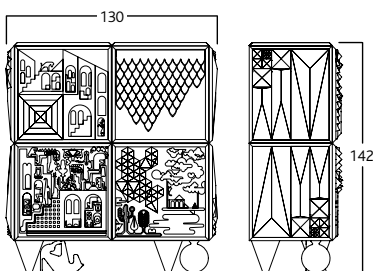

Module 120 Módulo 120	(2 units x 3.609)	7.218
Legs Patas	(4 units x 241)	964
Prism lateral Lateral prisma	(4 units x 321)	1.284
Flat top Top liso	(2 units x 281)	562
<b>TOTAL</b>		<b>10.028</b>

## PACKAGING

Module / Módulo Legs / Patas	PCS	DIMENSIONS CM	GROSS KG
Module / Módulo	2	138 x 67 x 82	188
Legs / Patas	1	65 x 60 x 35	6

## Example / Ejemplo 3A

TVBEJ03A034 Greyish White / Blanco grisáceo  
TVBEJ03A014 Graphite Grey / Gris grafito

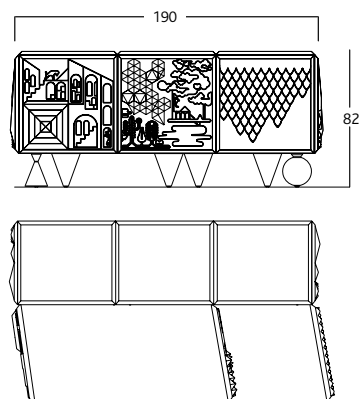

## Example / Ejemplo 3B

TVBEJ03B034 Greyish White / Blanco grisáceo  
TVBEJ03B014 Graphite Grey / Gris grafito

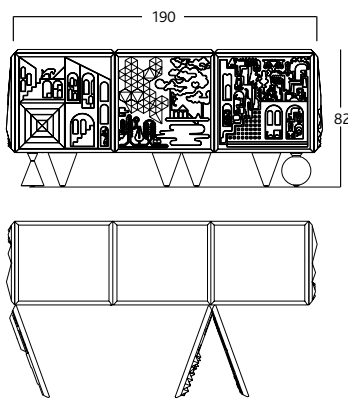

Module 120 Módulo 120	(1 unit x 3.609)	3.609
Module 60 Módulo 60	(1 unit x 2.047)	2.047
Legs Patas	(6 units x 241)	1.446
Prism lateral Lateral prisma	(2 units x 321)	642
Flat top Top liso	(3 units x 281)	843
<b>TOTAL</b>		<b>8.587</b>

## PACKAGING

Module / Módulo	PCS	DIMENSIONS CM	GROSS KG
Module / Módulo 120	1	138 x 67 x 82	94
Module / Módulo 60	1	78 x 66 x 82	61
Legs / Patas	1	65 x 60 x 35	9

Example / Ejemplo 4A

TVBEJ04A034 Greyish White / Blanco grisáceo  
 TVBEJ04A014 Graphite Grey / Gris grafito

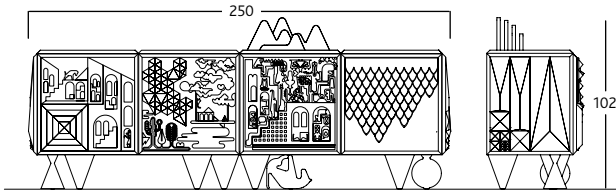

Module 120 <i>Módulo 120</i>	(2 units x 3.609)	7.218
Legs <i>Patas</i>	(8 units x 241)	1.928
Prism lateral <i>Lateral prisma</i>	(2 units x 321)	642
Flat top <i>Top liso</i>	(3 units x 281)	843
Top with mountain <i>Top con montaña</i>	(1 unit x 653)	653
<b>TOTAL</b>		<b>11.284</b>

PACKAGING

	PCS	DIMENSIONS CM	GROSS KG
Module / <i>Módulo</i>	1	138 x 67 x 82	94
Module with mountain / <i>Módulo con montaña</i>	1	138 x 67 x 101	97
Legs / <i>Patas</i>	1	65 x 50 x 50	18

Example / Ejemplo 4B

TVBEJ04B034 Greyish White / Blanco grisáceo  
 TVBEJ04B014 Graphite Grey / Gris grafito

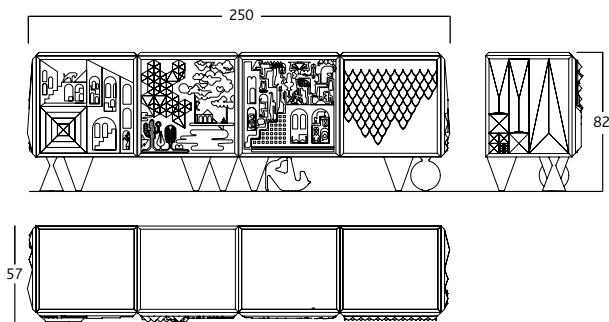

Module 120 <i>Módulo 120</i>	(2 unit x 3.609)	7.218
Legs <i>Patas</i>	(8 units x 241)	1.928
Prism lateral <i>Lateral prisma</i>	(2 units x 321)	642
Flat top <i>Top liso</i>	(4 units x 281)	1.124
<b>TOTAL</b>		<b>10.912</b>

PACKAGING

	PCS	DIMENSIONS CM	GROSS KG
Module / <i>Módulo 120</i>	2	138 x 67 x 82	188
Legs / <i>Patas</i>	1	60 x 50 x 50	18



**FREE PORT** (until stocks last / hasta agotar existencias)

Modules in MDF. Exterior sides lacquered in high gloss white (RAL 9010) and interior parts and edges veneered in different types of laminated woods. MDF doors lacquered in high gloss on the outside and matt on the inside. MDF shelves veneered in the same wood as the interior. Legs are made of cast aluminium and steel tube lacquered in high gloss chocolate brown. The union crosses are of anodised aluminium.

Contenedores en tablero MDF. Caras exteriores lacadas en blanco brillante (RAL 9010) y caras interiores y cantos aplacados con diferentes tipos de papel fenólico similar madera. Puertas en tablero de fibras MDF lacada brillante por fuera y mate por dentro. Estantes en tablero de fibras MDF chapados en papel fenólico similar madera. Patas en fundición de aluminio y tubo de hierro pintado brillante en marrón chocolate. Cruz de unión en aluminio anodizado.

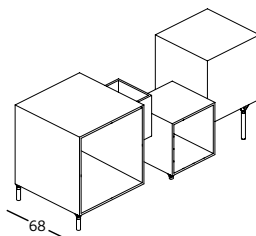
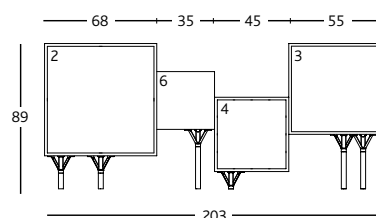
**Model A2****FREE PORT** (Boxes and legs / Cajas y patas)

FRMODELOA2 - Model A2 - 4 boxes / 4 cajas 4.853

## PACKAGING

	PCS	DIMENSIONS CM	GROSS KG
Module 68	1	74 x 74 x 74	38
Module 55	1	61 x 61 x 61	21
Module 45	1	51 x 51 x 51	16
Module 35	1	41 x 41 x 41	11

**HIALINA** (until stocks last / hasta agotar existencias)

Lluís Clotet &amp; Oscar Tusquets

Support in anodised silver matte aluminium hung on the wall and 6mm transparent tempered glass shelf with polished tinted edges.

Soporte en aluminio anodizado plata mate colgado a pared. Estante en vidrio transparente laminado 3+3 mm con cantos pulidos con una franja matizada.

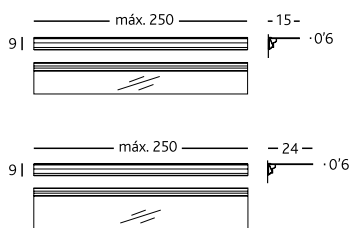

HI0786	<b>Matte aluminium profile / LM</b> (double support included) <i>Perfil de aluminio mate / ML</i> (incluye taco soporte doble)	70
HI0782	<b>15cm transparent glass / LM</b> <i>Vidrio 15cm transparente / ML</i>	184
HI0783	<b>24cm transparent glass / LM</b> <i>Vidrio 24cm transparente / ML</i>	236
HI0775	<b>Rubber support / LM</b> <i>Soporte de goma / ML</i>	6
HI0779	<b>Black wooden side cover / (1u)</b> (optional) <i>Tapa lateral madera negra / (1u)</i> (opcional)	12
HI0777	<b>Led light kit / Kit lámpara led</b> (optional / opcional) 1 M	190

- Luminous flux (lumens): 1.350 LM 14W/LM / T. 3.000K
- 1 Led Kit for every 50cm of shelf. Multiples of 50 cm.
- Led light kit certified by CE UNE-EN 60598-1.
- Maximum length of profile and shelf: 2.5m.
- Orders will be supplied cut to the requested length. Profiles and Led light kits are invoiced in multiples of 50cm.

- Flujo luminoso (lúmenes): 1.350 ML 14W / ML / T. 3.000K
- 1 Kit Led por cada 50cm de estantería. Múltiplos de 50 cm.
- Kit eléctrico led certificado por la CE UNE-EN 60598-1.
- Longitud máxima de perfil y estante: 2.5m.
- Los pedidos se entregarán cortados a la longitud solicitada. Los perfiles y los kits Led se facturarán en múltiplos de 50cm.

- Maximum load / Carga máxima
- 15 cm - 16 kg / LM
- 24 cm - 10 kg / LM

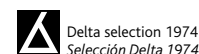

# HYPÓSTILA

Lluís Clotet & Oscar Tusquets

Shelves and vertical supports in extruded aluminium, brushed and anodised silver or black. Fixing metalwork in zincated iron. Feet in cast aluminium anodised silver or black. Screws in stainless steel.

The maximum distance between vertical supports for flat shelves is 150cm, 100cm for bar shelves, and 90cm for MDF shelves and tables.

Estantes y soporte vertical en extrusión de aluminio, cepillado y anodizado plata o negro. Herrajes de sujeción en hierro zincado. Pie en fundición de aluminio anodizada plata o negro. Tornillería en acero inoxidable.

La distancia máxima entre soportes verticales para estantes planos será de 150 cm. Para estantes de barras será de 100 cm. Para estantes o mesas de MDF será de 90 cm.



## PARTS / PIEZAS

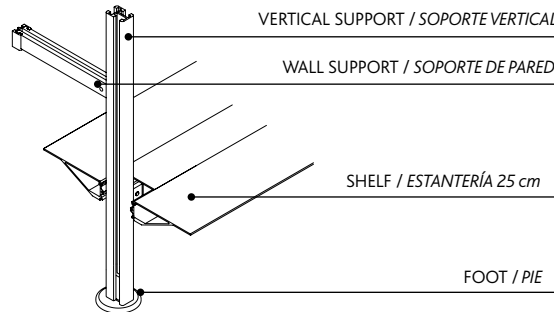
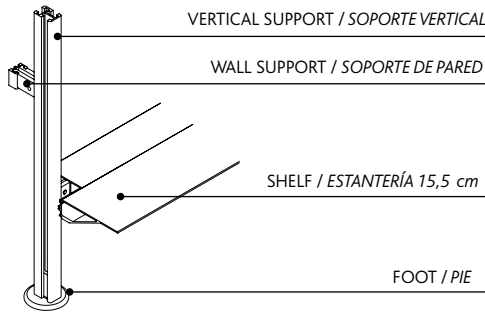

## SHELVES / ESTANTES

SHELF / ESTANTE 15,5 cm	HY0844	Silver / Plata	154/m
	HY0855	Black / Negro	154/m

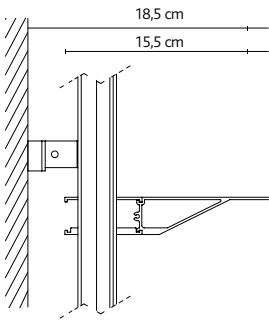
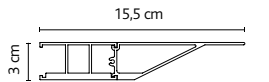

- Maximum bearing weight: 40Kg/LM. Equally distributed cargo weight.
- Maximum length: 250cm per shelf. Multiple pieces can be combined to obtain lengths longer than 250cm.
- The cost of the Hypóstila shelves will be calculated in multiples of 50cm, taking into account the total length of shelves ordered.
- Capacidad máxima: 40kg/m. Carga repartida.
- Longitud máxima: 250cm de una sola pieza. Se pueden combinar múltiples piezas para obtener longitudes superiores a 250cm.
- El coste de los estantes Hypóstila se efectuará a razón de múltiplos de 50cm teniendo en cuenta la suma total de los estantes de la composición.

WITHOUT CANTILEVER  
SIN VOLADIZO

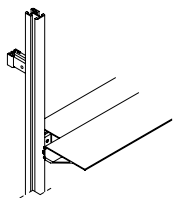

WITH CANTILEVER  
CON VOLADIZO

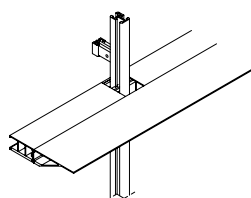

SHELF / ESTANTE 25 cm	HY0845	Silver / Plata	217/m
	HY0854	Black / Negro	217/m

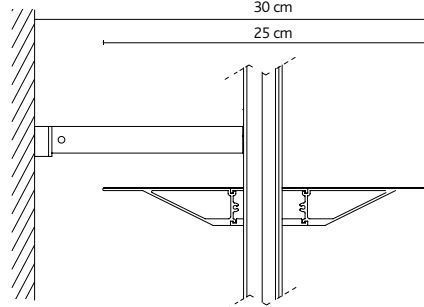
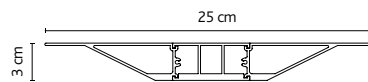

- Maximum bearing weight: 60Kg/LM. Equally distributed cargo weight.
- Maximum length: 250cm per shelf. Multiple pieces can be combined to obtain lengths longer than 250cm.
- The cost of the Hypóstila shelves will be calculated in multiples of 50cm, taking into account the total length of shelves ordered.
- Capacidad máxima: 60kg/m. Carga repartida.
- Longitud máxima: 250cm de una sola pieza. Se pueden combinar múltiples piezas para obtener longitudes superiores a 250cm.
- El coste de los estantes Hypóstila se efectuará a razón de múltiplos de 50cm teniendo en cuenta la suma total de los estantes de la composición.

WITHOUT CANTILEVER  
SIN VOLADIZO

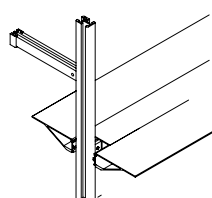

WITH CANTILEVER  
CON VOLADIZO

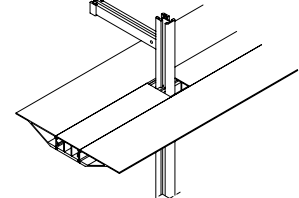

## ROUND CORNER / ESQUINA REDONDEADA

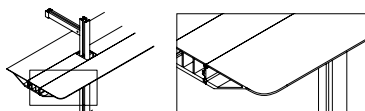

- The corners to be rounded must be indicated.
- Las esquinas a redondear deben ser indicadas.

HY0846	Rounded corner (each) / Esquina redondeada (cada una)	8
--------	---	---



**VERTICAL STRUCTURE / ESTRUCTURA VERTICAL**

Vertical structure for 15,5 cm shelf  
*Estructura vertical para estantes de 15,5 cm*

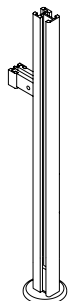

HY0838	Silver / Plata	2m	125€
HY0856	Black / Negro		
HY0839	Silver / Plata	3m	182€
HY0857	Black / Negro		
HY0840	Black / Negro	4m	226€
HY0858	Silver / Plata		

Vertical structure for 25 cm shelf  
*Estructura vertical para estantes de 25 cm*

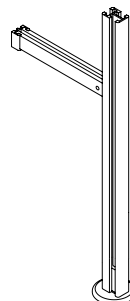

HY0841	Silver / Plata	2m	125€
HY0847	Black / Negro		
HY0842	Silver / Plata	3m	182€
HY0848	Black / Negro		
HY0843	Black / Negro	4m	226€
HY0849	Silver / Plata		

- Maximum height: 400cm.
- The cost of the Hypóstila vertical structure is calculated based on the highest measurement of the post.

- *Altura máxima: 400cm.*
- *El coste de la estructura vertical Hypóstila se calculará en base a la medida superior de poste.*

**DIMENSIONAL CONSTRAINTS / RESTRICCIONES DIMENSIONALES**

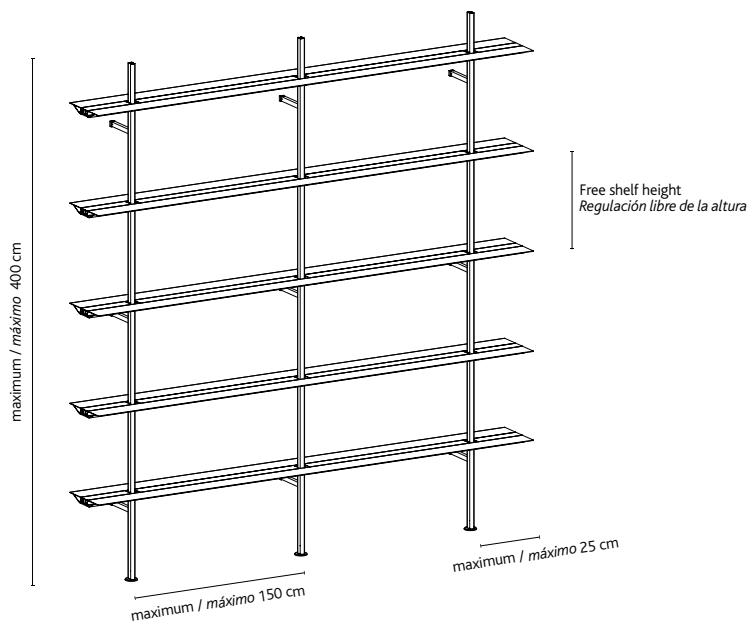

**FREE SHELF HEIGHT ADJUSTMENT  
REGULACIÓN LIBRE DE LA ALTURA DE LOS ESTANTES**

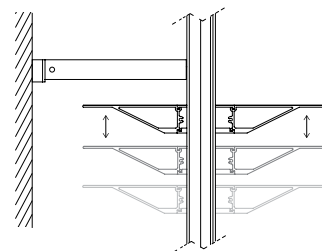

**ADJUSTMENT MECHANISM  
MECANISMO DE REGULACIÓN**

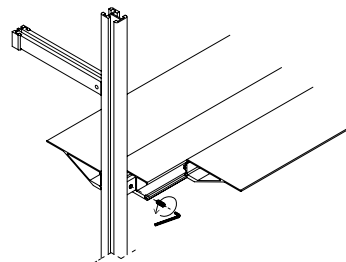

**HYPÓSTILA II - BAR SHELF (until stocks last / hasta agotar existencias)**

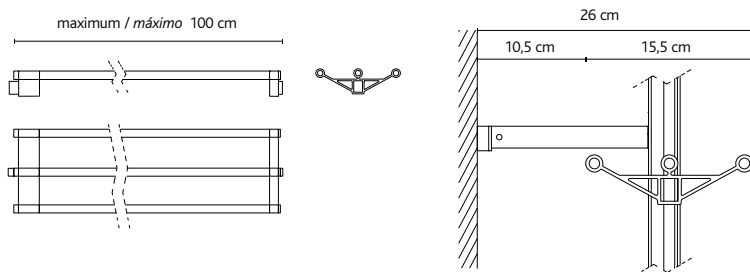

From 0 to 100cm  
De 0 a 100cm

Bar shelf / Estantería de barras 121€

# HYPÓSTILA EXAMPLES / EJEMPLOS (Silver finish / Acabado plata)

## EXAMPLE / EJEMPLO 1

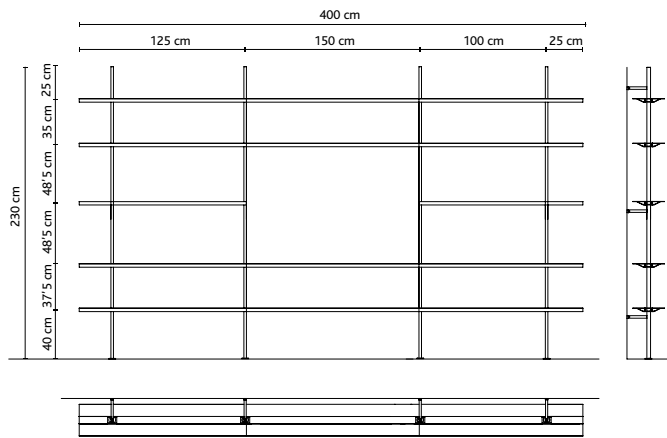

Vertical structure 3m <i>Estructura vertical 3m</i>	230cm (x4)	182 (x4)	728
Shelf 25cm <i>Estantería 25cm</i>	400cm (x4) = 16 m 125cm (x2) = 2'5 m	217 x 18'5m	4.014,5
<b>TOTAL</b>			<b>4.742,5</b>

85 kg  
 (x1) 10 x 10 x 240 cm (0.02 m<sup>3</sup>)  
 (x10) 13 x 12 x 160 cm (0.04 m<sup>3</sup>)  
 (x1) 18 x 18 x 13 cm (0.004 m<sup>3</sup>)

## EXAMPLE / EJEMPLO 2

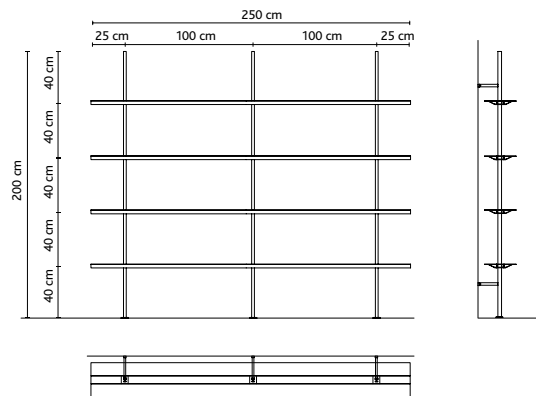

Vertical structure 2m <i>Estructura vertical 2m</i>	200cm (x3)	125 (x3)	375
Shelf 25cm <i>Estantería 25cm</i>	250cm (x4) = 10m	217 x 10m	2.170
<b>TOTAL</b>			<b>2.545</b>

47 kg  
 (x1) 16 x 9 x 210 cm (0.03m<sup>3</sup>)  
 (x2) 13 x 12 x 260 cm (0.04 m<sup>3</sup>)  
 (x1) 10 x 8 x 260 cm (0.02 m<sup>3</sup>)  
 (x1) 18 x 18 x 13 cm (0.004 m<sup>3</sup>)

## EXAMPLE / EJEMPLO 3

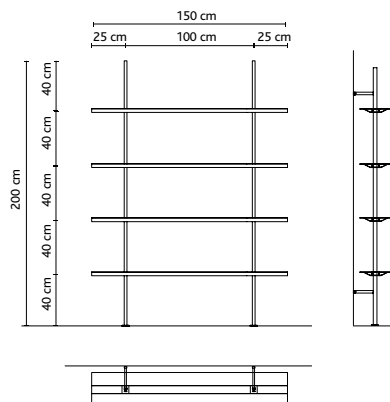

Vertical structure 2m <i>Estructura vertical 2m</i>	200cm (x2)	125 (x2)	250
Shelf 25cm <i>Estantería 25cm</i>	150cm (x4) = 6m	217 x 6m	1.302
<b>TOTAL</b>			<b>1.552</b>

30 kg  
 (x1) 8 x 10 x 210 cm (0.02 m<sup>3</sup>)  
 (x2) 13 x 12 x 160 cm (0.02 m<sup>3</sup>)  
 (x1) 10 x 8 x 160 cm (0.01 m<sup>3</sup>)  
 (x1) 18 x 18 x 13 cm (0.004 m<sup>3</sup>)

- The cost of the Hypóstila vertical structure is calculated based on the highest measurement of the post.
- The cost of the Hypóstila shelves will be calculated in multiples of 50cm, taking into account the total length of shelves ordered.
- *El coste de la estructura vertical Hypóstila se calculará en base a la medida superior de poste.*
- *El coste de los estantes Hypóstila se calculará en múltiplos de 50cm, teniendo en cuenta la longitud total de las estanterías solicitadas.*

## HYPÓSTILA EXAMPLES / EJEMPLOS (silver finish / Acabado plata)

## EXAMPLE / EJEMPLO 4

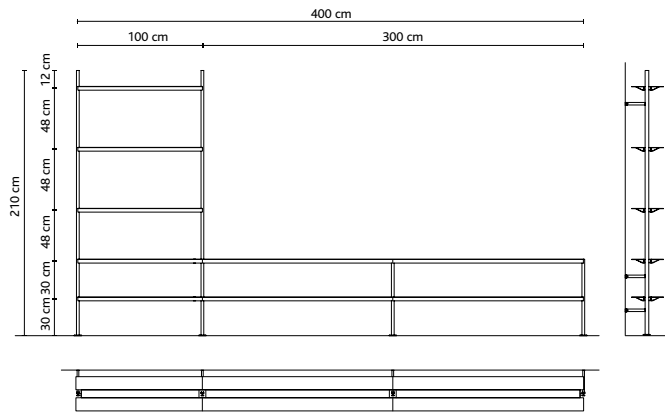

Vertical structure 2m & 3m <i>Estructura vertical 2m y 3m</i>	210cm (x2) 60cm (x2)	182 (x2) 125 (x2)	364 250
Shelf 25cm <i>Estantería 25cm</i>	100cm (x3)=3m 400cm (x2)=8m	217 x 11m	2.387
TOTAL			3.001

50 kg  
 (x1) 8 x 10 x 220 cm (0.02 m<sup>3</sup>)  
 (x3) 15 x 16 x 160 cm (0.04 m<sup>3</sup>)  
 (x2) 12 x 8 x 160 cm (0.02 m<sup>3</sup>)  
 (x1) 20 x 20 x 110 cm (0.04 m<sup>3</sup>)  
 (x1) 20 x 20 x 15 cm (0.006 m<sup>3</sup>)

TABLES  
MESASARMCHAIRS  
BUTACAS

## EXAMPLE / EJEMPLO 5

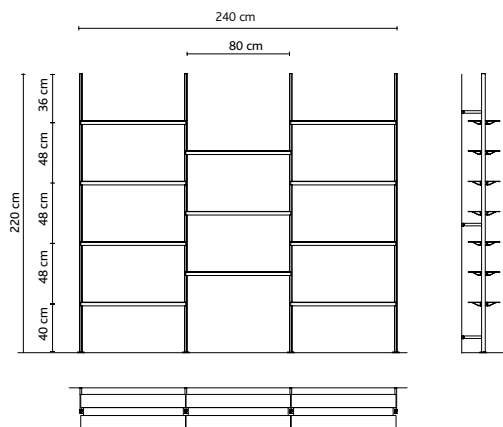

Vertical structure 3m <i>Estructura vertical 3m</i>	220cm (x4)	182 (x4)	728
Shelf 25cm <i>Estantería 25cm</i>	80cm (x11) = 8'8m	217 x 9m	1.953
TOTAL			2.681

46 kg  
 (x1) 8 x 10 x 230 cm (0.02 m<sup>3</sup>)  
 (x4) 17 x 15 x 90 cm (0.02 m<sup>3</sup>)  
 (x1) 24 x 15 x 90 cm (0.03 m<sup>3</sup>)  
 (x1) 18 x 18 x 13 cm (0.004 m<sup>3</sup>)

CHAIRS AND STOOLS  
SILLAS Y TABURETESACCESSORIES  
ACCESORIOS

## EXAMPLE / EJEMPLO 6

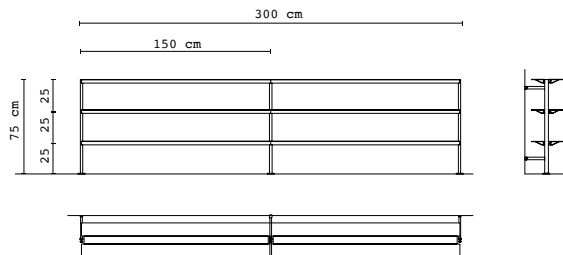

Vertical structure 2m <i>Estructura vertical 2m</i>	75cm (x3)	125 (x3)	375
Shelf 25cm <i>Estantería 25cm</i>	300cm (x3) = 9m	217 x 9m	1.953
TOTAL			2.328

38 kg  
 (x1) 8 x 10 x 91 cm (0.007 m<sup>3</sup>)  
 (x3) 17 x 15 x 160 cm (0.04 m<sup>3</sup>)  
 (x1) 18 x 18 x 13 cm (0.004 m<sup>3</sup>)

LIGHTING  
ILUMINACIÓNPUBLIC SEATING  
ASIENTOS PÚBLICOS

ART EDITIONS

- The cost of the Hypóstila vertical structure is calculated based on the highest measurement of the post.
- The cost of the Hypóstila shelves will be calculated in multiples of 50cm, taking into account the total length of shelves ordered.
- El coste de la estructura vertical Hypóstila se calculará en base a la medida superior de poste.
- El coste de los estantes Hypóstila se calculará en múltiplos de 50cm, teniendo en cuenta la longitud total de las estanterías solicitadas.

HYPÓSTILA EXAMPLES / EJEMPLOS (Silver finish / Acabado plata)

EXAMPLE / EJEMPLO 7

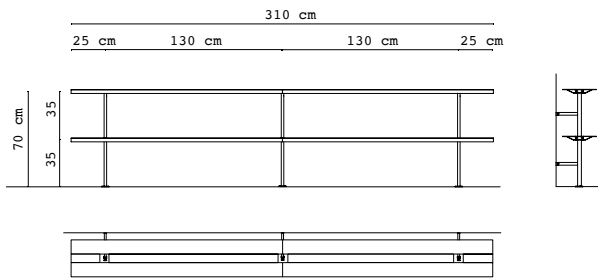

Vertical structure 2m Estructura vertical 2m	70cm (x3)	125 (x3)	375
	310cm (x2) = 6,2m	217 x 6,5m	1.410,50
			1.785,50

CORNISA

Lluís Clotet & Oscar Tusquets

Support and shelves in matt silver anodised aluminum, black anodised, painted white and powder coated according to RAL chart. Maximum length of one shelf is 2.5m.

Soporte y estantes en aluminio anodizado plata mate, anodizado negro, pintado blanco y pintado color cliente según carta RAL. Longitud máxima de una sola pieza 2,5m.

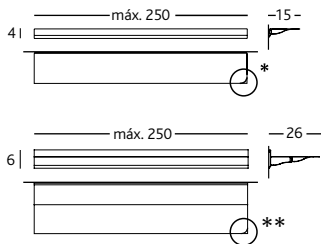

EC0760	Anodized silver / Anodizado plata	15 cm LM / ML	106
EC0761	Anodized silver / Anodizado plata	26 cm LM / ML	202
EC0762	Anodized black / Anodizado negro	15 cm LM / ML	116
EC0763	Anodized black / Anodizado negro	26 cm LM / ML	210
EC0764	Powder coated white / Pintado negro	15 cm LM / ML	147
EC0765	Powder coated white / Pintado negro	26 cm LM / ML	242
	Powder coated custom colour (consult RAL chart) / Pintado color cliente (consultar carta RAL)	15 cm LM / ML (min 4 m)	168
	Powder coated custom colour (consult RAL chart) / Pintado color cliente (consultar carta RAL)	26 cm LM / ML (min 2 m)	315

- Orders will be supplied cut to the requested length and invoiced in multiples of 50 cm.
- Los pedidos se servirán cortados a la medida que nos soliciten y se facturarán en múltiplos de 50cm.

\* Consult conditions / Consultar condiciones

ACCESSORIES AND EXTRAS / ACCESORIOS Y EXTRAS

HY0846	To round each corner / Redondeo voladizo en cada esquina	8
--------	--	---

\*\* Corners to be rounded must be indicated  
Las esquinas a redondear deben ser indicadas.

- Maximun load (always load distributed)  
15 cm - 35 kg / LM  
26 cm - 20 kg / LM
- Carga máxima (siempre carga repartida)  
15 cm - 35 kg / ML  
26 cm - 20 kg / ML

ESBELTA (until stocks last / hasta agotar existencias)

ESBELTA - FIXTURE FROM FLOOR TO CEILING / SOPORTE SIMPLE A TECHO

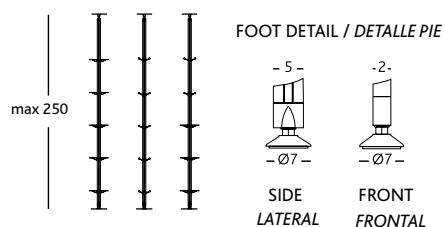

SUPPORT FOR FLAT SHELVES 25cm AND BARS 15'5cm  
SOPORTE PARA ESTANTES PLANOS 25cm Y BARRAS 15'5cm

HY38501	Silver / Plata	H.2,5m - 1 un.	335
HY38601	Black Edition		

\*Maximum height 250cm / Altura máxima 250cm

ESBELTA EXAMPLE / EJEMPLO

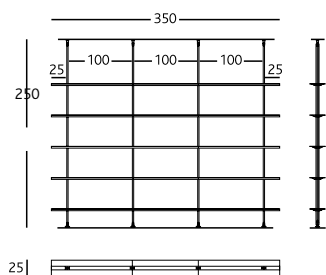

ESBELTA			
HY3850	Vertical supports / Soportes verticales ESBELTA H.3m - (4u x 335€)		1340
HY0845	Flat shelf / Estante plano HYP I, 25cm - (17'5m x 217€)		3.797,50
TOTAL 350 x 25 x H.250cm			5.137,50

## TABLES / MESAS

### GAULINO

**TOP** in MDF veneered walnut wood, varnished nature effect or ash with two finishes: natural varnished or open pore lacquered in black. The underside and edges are lacquered according to the top finish: RAL 1001 in case of natural ash; RAL 9005 for the ash stained walnut and or the black lacquered top.

**LEGS:** Solid structure in walnut wood, varnished nature effect (for only the version in 240cm) or solid ash wood with three optional finishes: natural varnished, stained walnut and varnished (only for the version of 300cm) or open pore lacquered in black.

**SOBRE** en MDF chapado en nogal barnizado efecto nature, o en fresno con dos acabados: barnizado natural o lacado negro a poro abierto. La parte inferior y el canto van lacados según el acabado del sobre: fresno natural en RAL 1001; nogal y fresno lacado negro en RAL 9005.

**PATAS:** Estructura maciza de nogal barnizado efecto nature (solo para modelo de 240cm.) o en fresno, con tres opciones diferentes: barnizado natural, teñido color nogal y barnizado (solo para modelo de 300cm.) o lacado negro a poro abierto.

Table / Mesa 240 cm

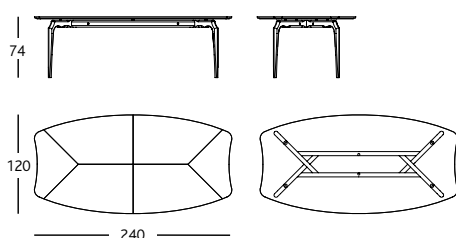
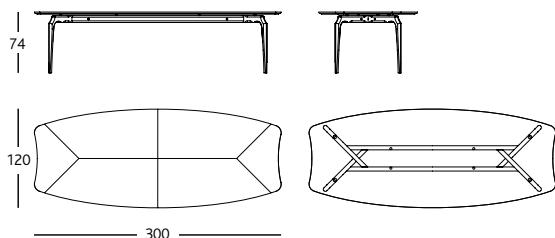
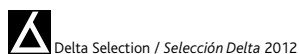

	Table 240 cm	Table 300 cm
Natural wood / <i>Madera natural</i>	4.160	4.595
Black / <i>Negra</i>	4.741	5.076
Walnut / <i>Nogal</i>	4.910	5.636

Table / Mesa 300



See matching chair on page 69 / *Ver silla o a juego en página 69.*



#### PACKAGING

	PCS	DIMENSIONS CM	GROSS KG
<b>MODEL 240</b>			
Cross-piece (legs) / <i>Travesaño</i>	1	13 x 13 x 194	14
Legs / <i>Patás</i>	2	75 x 13 x 80	14
Wood top / <i>Sobre madera</i>	1	250 x 15 x 130	86
<b>MODEL 300</b>			
Cross-piece (legs) / <i>Travesaño</i>	1	15 x 17 x 252	16
Legs / <i>Patás</i>	2	75 x 13 x 80	14
Wood top / <i>Sobre madera</i>	1	311 x 15 x 130	120



**TABLE B**

TOP in extruded, scotch polished and anodized silver aluminium. Surface laminating available in matte Polaris from Abet Laminati or natural oak.  
LEGS OPTIONS

- Architectural concrete in grey with steel concrete base fastening plate painted in epoxy polyester, silver color, for both interior and exterior use.
- Solid ash stained and varnished oak wooden legs, for indoor use only.
- Rod legs in electro polished stainless steel, for both indoor and outdoor use.
- Cast painted aluminium for both indoor and outdoor use.

*SOBRE en extrusión de aluminio pulido scotch y anodizado plata. La cara superior se puede chapar en estratificado Polaris mate de Abet Laminati o en roble natural.*

**OPCIONES DE PATAS**

- *Hormigón arquitectónico en color gris con pletina sujeción base hormigón de acero pintado en epoxi poliéster, color plata, para uso tanto interior como exterior.*
- *Patatas de madera maciza de fresno teñido color roble y barnizado, solo para uso interior.*
- *Patatas de varilla en acero inoxidable electro pulido, para uso tanto interior como exterior.*
- *Patatas en fundición de aluminio pintado, para uso tanto interior como exterior.*

**WIDTHS / ANCHOS**

TABLE B DESK

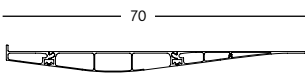

TABLE B 90

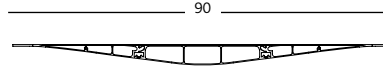

TABLE B 120

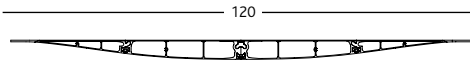
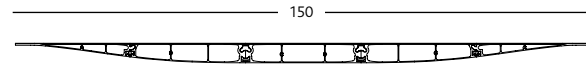

TABLE B 150



LEGS	TABLE B DESK	TABLE B 90	TABLE B 120	TABLE B 150
Wood legs Patatas madera				
Wood trestle Caballete madera				
Stainless steel Acero inoxidable				
Concrete Hormigón				
Aluminium Aluminio				

# TABLE B GENERAL DIMENSIONS

## TABLE B DESK

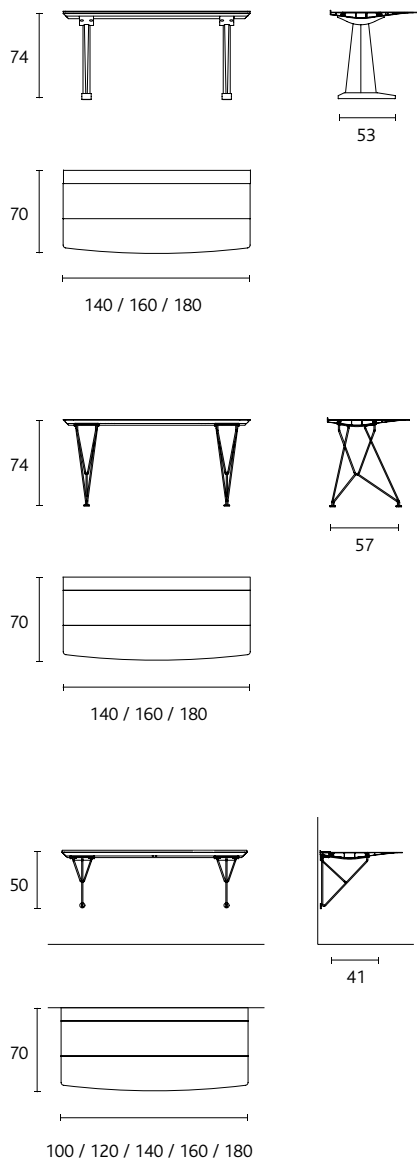

## TABLE B 90

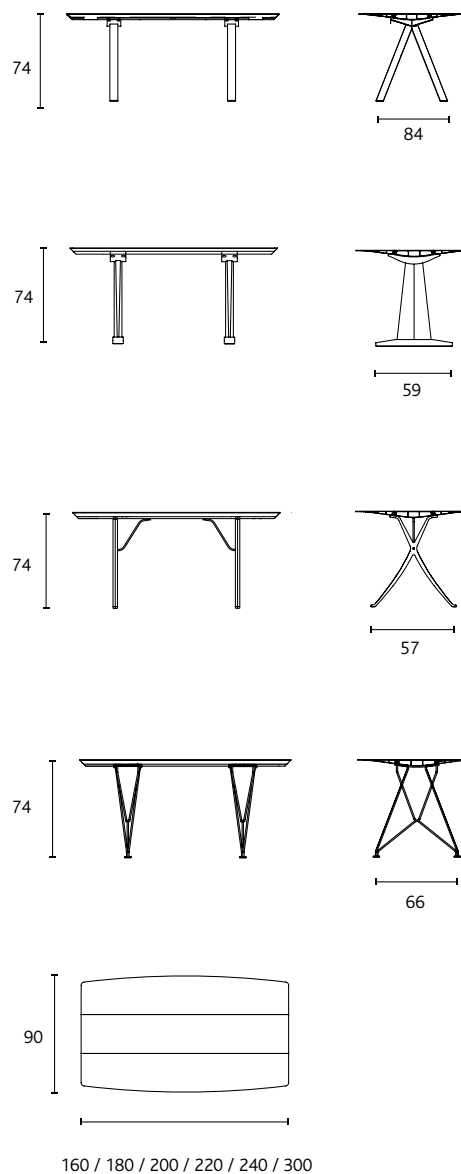

TABLE B GENERAL DIMENSIONS

TABLE B 120

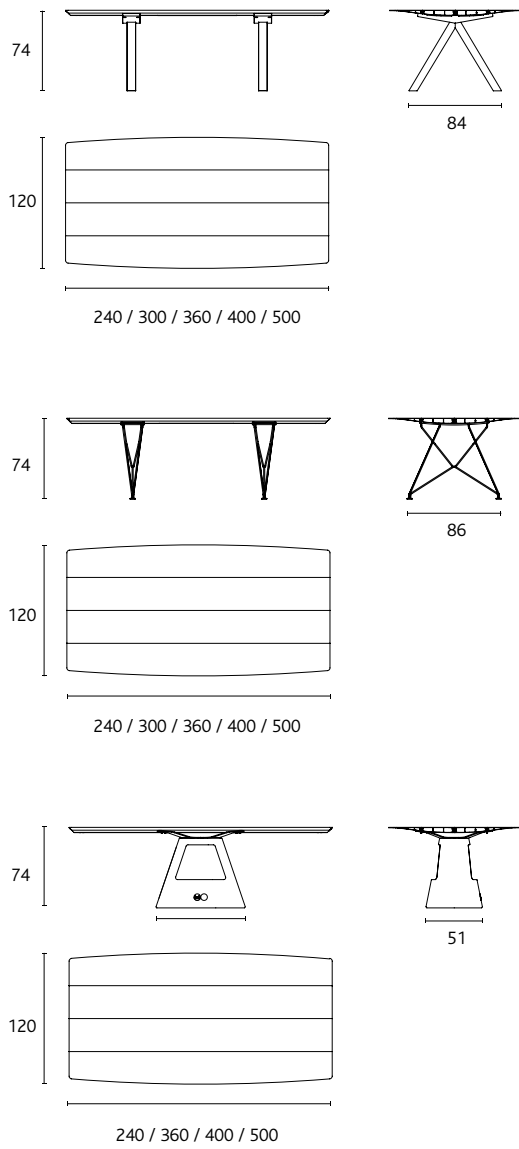
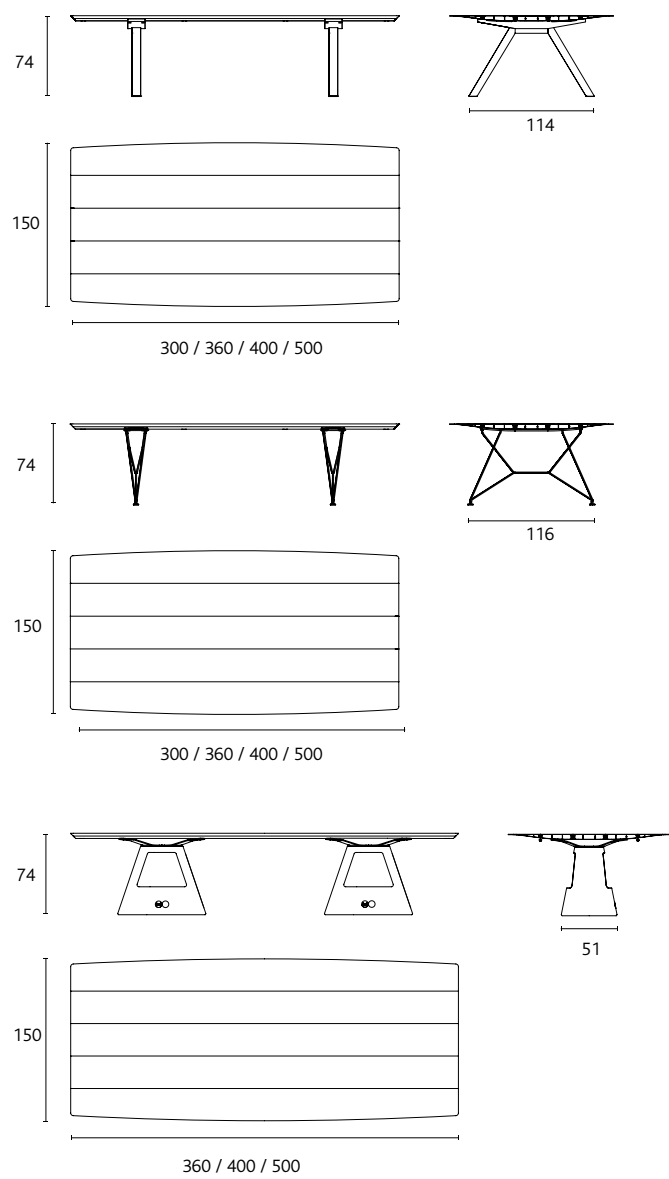
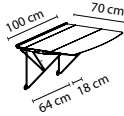

TABLE B 150



## TABLE B DESK

### LENGTH / LONGITUD 100 cm



LEGS Stainless Steel (wall) / Acero inoxidable (pared)

TOP Anodized silver / Anodizado plata 2.590

PACKAGING			
	PCS	DIMENSIONS CM	GROSS KG
Legs / Patas	1	90 x 80 x 60	15
Top / Sobre	1	120 x 20 x 90	24

### LENGTH / LONGITUD 120 cm

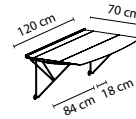

LEGS Stainless Steel (wall) / Acero inoxidable (pared)

TOP Anodized silver / Anodizado plata 2.683

PACKAGING			
	PCS	DIMENSIONS CM	GROSS KG
Legs / Patas	1	90 x 80 x 60	15
Top / Sobre	1	140 x 20 x 90	26

### LENGTH / LONGITUD 140 cm

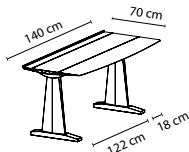

LEGS Wooden trestle / Caballete madera

TOP Anodized silver / Anodizado plata 3.047

PACKAGING			
	PCS	DIMENSIONS CM	GROSS KG
Legs / Patas	1	90 x 80 x 40	21
Top / Sobre	1	160 x 20 x 90	28



LEGS Stainless Steel / Acero inoxidable

TOP Anodized silver / Anodizado plata 2.985

PACKAGING			
	PCS	DIMENSIONS CM	GROSS KG
Legs / Patas	1	90 x 80 x 80	18
Top / Sobre	1	160 x 20 x 90	28

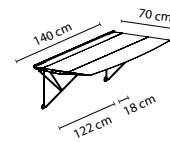

LEGS Stainless Steel (wall) / Acero inoxidable (pared)

TOP Anodized silver / Anodizado plata 2.777

PACKAGING			
	PCS	DIMENSIONS CM	GROSS KG
Legs / Patas	1	90 x 80 x 60	15
Top / Sobre	1	160 x 20 x 90	28

### LENGTH / LONGITUD 160 cm

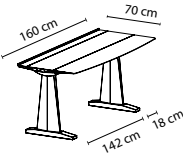

LEGS Wooden trestle / Caballete madera

TOP Anodized silver / Anodizado plata 3.214

PACKAGING			
	PCS	DIMENSIONS CM	GROSS KG
Legs / Patas	1	90 x 80 x 40	21
Top / Sobre	1	180 x 20 x 90	30

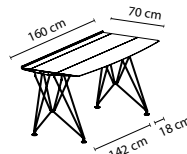

LEGS Stainless Steel / Acero inoxidable

TOP Anodized silver / Anodizado plata 3.151

PACKAGING			
	PCS	DIMENSIONS CM	GROSS KG
Legs / Patas	1	90 x 80 x 80	18
Top / Sobre	1	180 x 20 x 90	30

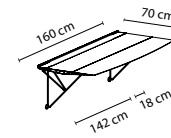

LEGS Stainless Steel (wall) / Acero inoxidable (pared)

TOP Anodized silver / Anodizado plata 2.943

PACKAGING			
	PCS	DIMENSIONS CM	GROSS KG
Legs / Patas	1	90 x 80 x 60	15
Top / Sobre	1	180 x 20 x 90	30

### LENGTH / LONGITUD 180 cm

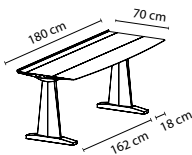

LEGS Wooden trestle / Caballete madera

TOP Anodized silver / Anodizado plata 3.385

PACKAGING			
	PCS	DIMENSIONS CM	GROSS KG
Legs / Patas	1	90 x 80 x 40	21
Top / Sobre	1	200 x 20 x 90	35

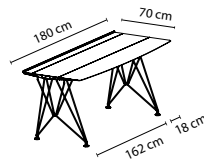

LEGS Stainless Steel / Acero inoxidable

TOP Anodized silver / Anodizado plata 3.323

PACKAGING			
	PCS	DIMENSIONS CM	GROSS KG
Legs / Patas	1	90 x 80 x 80	18
Top / Sobre	1	200 x 20 x 90	35

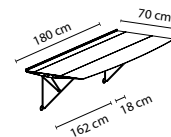

LEGS Stainless Steel (wall) / Acero inoxidable (pared)

TOP Anodized silver / Anodizado plata 3.115

PACKAGING			
	PCS	DIMENSIONS CM	GROSS KG
Legs / Patas	1	90 x 80 x 60	15
Top / Sobre	1	200 x 20 x 90	35



## TABLE B 90

## LENGTH / LONGITUD 160 cm

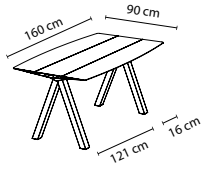

LEGS	Wood / <i>Madera</i>	
	Anodized silver <i>Anodizado plata</i>	3.593
TOP	Laminated <i>Laminado</i>	4.971
	Natural oak <i>Roble natural</i>	

## PACKAGING

	PCS	DIMENSIONS CM	GROSS KG
Legs / <i>Patas</i>	1	90 x 80 x 40	18
Top / <i>Sobre</i>	1	180 x 20 x 110	34

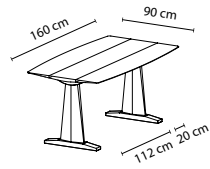

LEGS	Wooden trestle / <i>Caballette madera</i>	
	Anodized silver <i>Anodizado plata</i>	3.551
TOP	Laminated <i>Laminado</i>	4.926
	Natural oak <i>Roble natural</i>	

## PACKAGING

	PCS	DIMENSIONS CM	GROSS KG
Legs / <i>Patas</i>	1	90 x 80 x 40	20
Top / <i>Sobre</i>	1	180 x 20 x 110	34

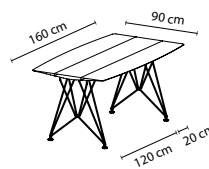

LEGS	Stainless Steel / <i>Acero inoxidable</i>	
	Anodized silver <i>Anodizado plata</i>	3.487
TOP	Laminated <i>Laminado</i>	4.861
	Natural oak <i>Roble natural</i>	

## PACKAGING

	PCS	DIMENSIONS CM	GROSS KG
Legs / <i>Patas</i>	1	90 x 80 x 80	15
Top / <i>Sobre</i>	1	180 x 20 x 110	34

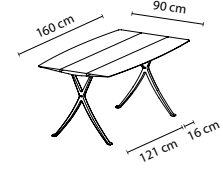

LEGS	Aluminium / <i>Aluminio</i>	
	Anodized silver <i>Anodizado plata</i>	3.434
TOP	Laminated <i>Laminado</i>	4.811
	Natural oak <i>Roble natural</i>	

## PACKAGING

	PCS	DIMENSIONS CM	GROSS KG
Legs / <i>Patas</i>	1	90 x 80 x 40	16
Top / <i>Sobre</i>	1	180 x 20 x 110	34

## LENGTH / LONGITUD 180 cm

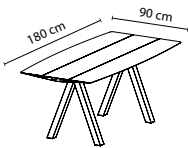

LEGS	Wood / <i>Madera</i>	
	Anodized silver <i>Anodizado plata</i>	3.779
TOP	Laminated <i>Laminado</i>	5.156
	Natural oak <i>Roble natural</i>	

## PACKAGING

	PCS	DIMENSIONS CM	GROSS KG
Legs / <i>Patas</i>	1	90 x 80 x 40	18
Top / <i>Sobre</i>	1	200 x 20 x 110	38

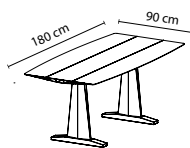

LEGS	Wooden trestle / <i>Caballette madera</i>	
	Anodized silver <i>Anodizado plata</i>	3.737
TOP	Laminated <i>Laminado</i>	5.111
	Natural oak <i>Roble natural</i>	

## PACKAGING

	PCS	DIMENSIONS CM	GROSS KG
Legs / <i>Patas</i>	1	90 x 80 x 40	20
Top / <i>Sobre</i>	1	200 x 20 x 110	38

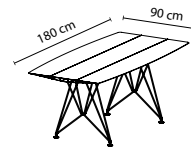

LEGS	Stainless Steel / <i>Acero inoxidable</i>	
	Anodized silver <i>Anodizado plata</i>	3.673
TOP	Laminated <i>Laminado</i>	5.051
	Natural oak <i>Roble natural</i>	

## PACKAGING

	PCS	DIMENSIONS CM	GROSS KG
Legs / <i>Patas</i>	1	90 x 80 x 80	15
Top / <i>Sobre</i>	1	200 x 20 x 110	38

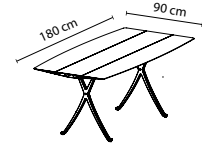

LEGS	Aluminium / <i>Aluminio</i>	
	Anodized silver <i>Anodizado plata</i>	3.620
TOP	Laminated <i>Laminado</i>	4.991
	Natural oak <i>Roble natural</i>	

## PACKAGING

	PCS	DIMENSIONS CM	GROSS KG
Legs / <i>Patas</i>	1	90 x 80 x 40	16
Top / <i>Sobre</i>	1	200 x 20 x 110	38

## LENGTH / LONGITUD 200 cm

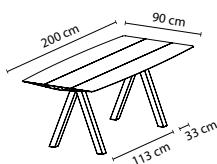

LEGS	Wood / <i>Madera</i>	
	Anodized silver <i>Anodizado plata</i>	4.017
TOP	Laminated <i>Laminado</i>	5.491
	Natural oak <i>Roble natural</i>	

## PACKAGING

	PCS	DIMENSIONS CM	GROSS KG
Legs / <i>Patas</i>	1	90 x 80 x 40	18
Top / <i>Sobre</i>	1	220 x 20 x 110	45

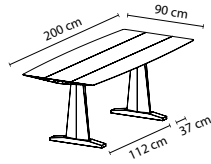

LEGS	Wooden trestle / <i>Caballette madera</i>	
	Anodized silver <i>Anodizado plata</i>	3.975
TOP	Laminated <i>Laminado</i>	5.496
	Natural oak <i>Roble natural</i>	

## PACKAGING

	PCS	DIMENSIONS CM	GROSS KG
Legs / <i>Patas</i>	1	90 x 80 x 40	20
Top / <i>Sobre</i>	1	220 x 20 x 110	45

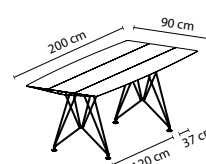

LEGS	Stainless Steel / <i>Acero inoxidable</i>	
	Anodized silver <i>Anodizado plata</i>	3.911
TOP	Laminated <i>Laminado</i>	5.381
	Natural oak <i>Roble natural</i>	

## PACKAGING

	PCS	DIMENSIONS CM	GROSS KG
Legs / <i>Patas</i>	1	90 x 80 x 80	15
Top / <i>Sobre</i>	1	220 x 20 x 110	45

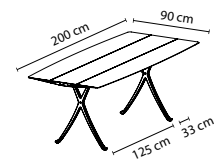

LEGS	Aluminium / <i>Aluminio</i>	
	Anodized silver <i>Anodizado plata</i>	3.858
TOP	Laminated <i>Laminado</i>	5.331
	Natural oak <i>Roble natural</i>	

## PACKAGING

	PCS	DIMENSIONS CM	GROSS KG
Legs / <i>Patas</i>	1	90 x 80 x 40	16
Top / <i>Sobre</i>	1	220 x 20 x 110	45

## TABLE B 90

### LENGTH / LONGITUD 220 cm

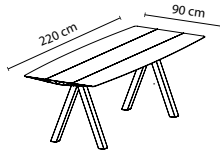

LEGS	Wood / Madera	
TOP	Anodized silver Anodizado plata	4.134
	Laminated Laminado	5.636
	Natural oak Roble natural	

#### PACKAGING

	PCS	DIMENSIONS CM	GROSS KG
Legs / Patas	1	90 x 80 x 40	18
Top / Sobre	1	240 x 20 x 110	48

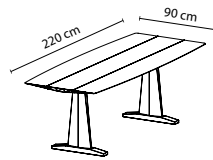

LEGS	Wooden trestle / Caballete madera	
TOP	Anodized silver Anodizado plata	4.092
	Laminated Laminado	5.596
	Natural oak Roble natural	

#### PACKAGING

	PCS	DIMENSIONS CM	GROSS KG
Legs / Patas	1	90 x 80 x 40	20
Top / Sobre	1	240 x 20 x 110	48

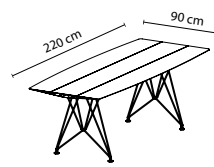

LEGS	Stainless Steel / Acero inoxidable	
TOP	Anodized silver Anodizado plata	4.028
	Laminated Laminado	5.531
	Natural oak Roble natural	

#### PACKAGING

	PCS	DIMENSIONS CM	GROSS KG
Legs / Patas	1	90 x 80 x 80	15
Top / Sobre	1	240 x 20 x 110	48

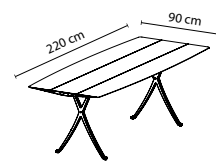

LEGS	Aluminium / Aluminio	
TOP	Anodized silver Anodizado plata	3.975
	Laminated Laminado	5.476
	Natural oak Roble natural	

#### PACKAGING

	PCS	DIMENSIONS CM	GROSS KG
Legs / Patas	1	90 x 80 x 40	16
Top / Sobre	1	240 x 20 x 110	48

### LENGTH / LONGITUD 240 cm

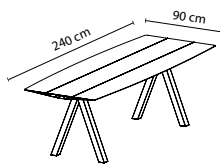

LEGS	Wood / Madera	
TOP	Anodized silver Anodizado plata	4.362
	Laminated Laminado	5.906
	Natural oak Roble natural	

#### PACKAGING

	PCS	DIMENSIONS CM	GROSS KG
Legs / Patas	1	90 x 80 x 40	18
Top / Sobre	1	260 x 20 x 110	54

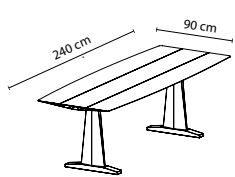

LEGS	Wooden trestle / Caballete madera	
TOP	Anodized silver Anodizado plata	4.320
	Laminated Laminado	5.866
	Natural oak Roble natural	

#### PACKAGING

	PCS	DIMENSIONS CM	GROSS KG
Legs / Patas	1	90 x 80 x 40	20
Top / Sobre	1	260 x 20 x 110	54

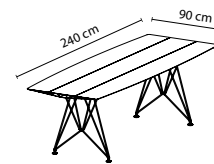

LEGS	Stainless Steel / Acero inoxidable	
TOP	Anodized silver Anodizado plata	4.256
	Laminated Laminado	5.801
	Natural oak Roble natural	

#### PACKAGING

	PCS	DIMENSIONS CM	GROSS KG
Legs / Patas	1	90 x 80 x 80	15
Top / Sobre	1	260 x 20 x 110	54

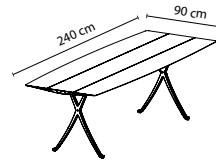

LEGS	Aluminium / Aluminio	
TOP	Anodized silver Anodizado plata	4.203
	Laminated Laminado	5.751
	Natural oak Roble natural	

#### PACKAGING

	PCS	DIMENSIONS CM	GROSS KG
Legs / Patas	1	90 x 80 x 40	16
Top / Sobre	1	260 x 20 x 110	54

### LENGTH / LONGITUD 300 cm

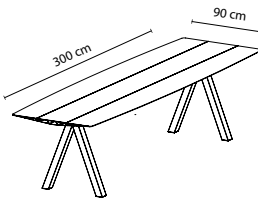

LEGS	Wood / Madera	
TOP	Anodized silver Anodizado plata	4.823
	Laminated Laminado	6.651
	Natural oak Roble natural	

#### PACKAGING

	PCS	DIMENSIONS CM	GROSS KG
Legs / Patas	1	90 x 80 x 40	18
Top / Sobre	1	320 x 20 x 110	72

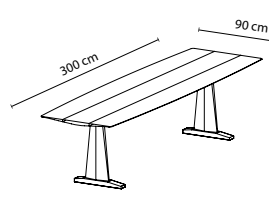

LEGS	Wooden trestle / Caballete madera	
TOP	Anodized silver Anodizado plata	4.781
	Laminated Laminado	6.606
	Natural oak Roble natural	

#### PACKAGING

	PCS	DIMENSIONS CM	GROSS KG
Legs / Patas	1	90 x 80 x 40	20
Top / Sobre	1	320 x 20 x 110	72

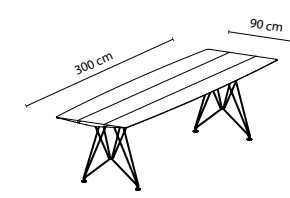

LEGS	Stainless Steel / Acero inoxidable	
TOP	Anodized silver Anodizado plata	4.717
	Laminated Laminado	6.546
	Natural oak Roble natural	

#### PACKAGING

	PCS	DIMENSIONS CM	GROSS KG
Legs / Patas	1	90 x 80 x 80	15
Top / Sobre	1	320 x 20 x 110	72

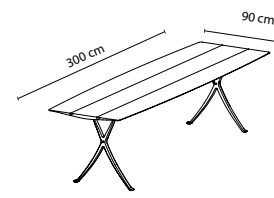

LEGS	Aluminium / Aluminio	
TOP	Anodized silver Anodizado plata	4.664
	Laminated Laminado	6.491
	Natural oak Roble natural	

#### PACKAGING

	PCS	DIMENSIONS CM	GROSS KG
Legs / Patas	1	90 x 80 x 40	16
Top / Sobre	1	320 x 20 x 110	72

## TABLE B 120 cm

All prices are for the complete table (Top + Legs)  
 Todos los precios son para la mesa completa (Sobre + Patas)

### LENGTH / LONGITUD 240 cm

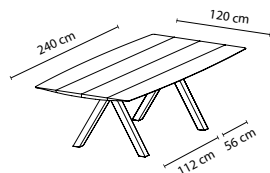

LEGS	Wood / Madera	
TOP	Anodized silver Anodizado plata	5.801
	Laminated Laminado	8.176
	Natural oak Roble natural	

PACKAGING			
	PCS	DIMENSIONS CM	GROSS KG
Legs / Patas	1	90 x 40 x 80	22
Top / Sobre	1	260 x 20 x 140	95

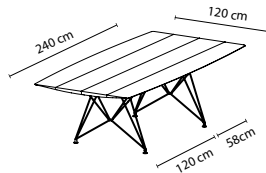

LEGS	Stainless Steel / Acero inoxidable	
TOP	Anodized silver Anodizado plata	5.607
	Laminated Laminado	7.976
	Natural oak Roble natural	

PACKAGING			
	PCS	DIMENSIONS CM	GROSS KG
Legs / Patas	1	90 x 40 x 80	23
Top / Sobre	1	260 x 20 x 140	95

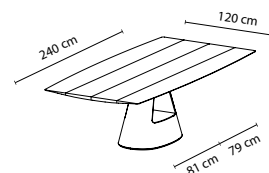

LEGS	Concrete / Hormigón	
TOP	Anodized silver Anodizado plata	5.897
	Laminated Laminado	8.460
	Natural oak Roble natural	

PACKAGING			
	PCS	DIMENSIONS CM	GROSS KG
Legs / Patas	1	120 x 80 x 85	90
Top / Sobre	1	260 x 20 x 140	95

### LENGTH / LONGITUD 300 cm

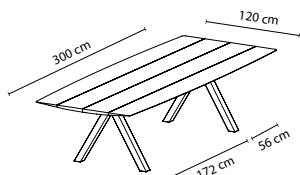

LEGS	Wood / Madera	
TOP	Anodized silver Anodizado plata	6.437
	Laminated Laminado	9.048
	Natural oak Roble natural	

PACKAGING			
	PCS	DIMENSIONS CM	GROSS KG
Legs / Patas	1	90 x 40 x 80	22
Top / Sobre	1	320 x 20 x 140	152

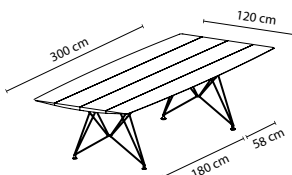

LEGS	Stainless Steel / Acero inoxidable	
TOP	Anodized silver Anodizado plata	6.243
	Laminated Laminado	8.849
	Natural oak Roble natural	

PACKAGING			
	PCS	DIMENSIONS CM	GROSS KG
Legs / Patas	1	90 x 40 x 80	23
Top / Sobre	1	320 x 20 x 140	152

### LENGTH / LONGITUD 360 cm

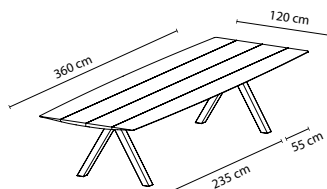

LEGS	Wood / Madera	
TOP	Anodized silver Anodizado plata	7.255
	Laminated Laminado	10.276
	Natural oak Roble natural	

PACKAGING			
	PCS	DIMENSIONS CM	GROSS KG
Legs / Patas	1	90 x 40 x 80	22
Top / Sobre	1	380 x 20 x 140	185

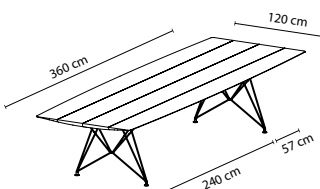

LEGS	Stainless Steel / Acero inoxidable	
TOP	Anodized silver Anodizado plata	7.064
	Laminated Laminado	9.893
	Natural oak Roble natural	

PACKAGING			
	PCS	DIMENSIONS CM	GROSS KG
Legs / Patas	1	90 x 40 x 80	23
Top / Sobre	1	380 x 20 x 140	185

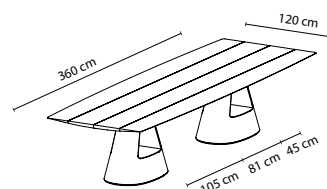

LEGS	Concrete / Hormigón	
TOP	Anodized silver Anodizado plata	9.015
	Laminated Laminado	12.380
	Natural oak Roble natural	

PACKAGING			
	PCS	DIMENSIONS CM	GROSS KG
Legs / Patas	2	120 x 80 x 85	180
Top / Sobre	1	380 x 20 x 140	185

## TABLE B 120 cm

All prices are for the complete table (Top + Legs)  
 Todos los precios son para la mesa completa (Sobre + Patas)

### LENGTH / LONGITUD 400 cm

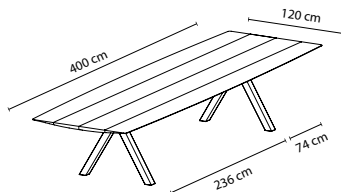

LEGS	Wood / Madera	
TOP	Anodized silver Anodizado plata	8.401
	Laminated Laminado	11.603
	Natural oak Roble natural	

#### PACKAGING

	PCS	DIMENSIONS CM	GROSS KG
Legs / Patas	1	90 x 40 x 80	22
Top / Sobre	1	420 x 20 x 140	205

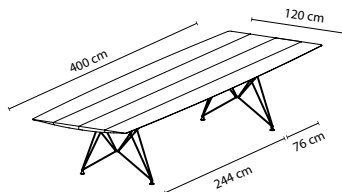

LEGS	Stainless Steel / Acero inoxidable	
TOP	Anodized silver Anodizado plata	8.207
	Laminated Laminado	11.404
	Natural oak Roble natural	

#### PACKAGING

	PCS	DIMENSIONS CM	GROSS KG
Legs / Patas	1	90 x 40 x 80	23
Top / Sobre	1	420 x 20 x 140	205

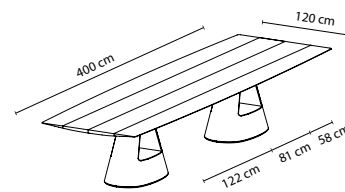

LEGS	Concrete / Hormigón	
TOP	Anodized silver Anodizado plata	10.213
	Laminated Laminado	13.756
	Natural oak Roble natural	

#### PACKAGING

	PCS	DIMENSIONS CM	GROSS KG
Legs / Patas	2	120 x 80 x 85	180
Top / Sobre	1	420 x 20 x 140	205

### LENGTH / LONGITUD 500 cm

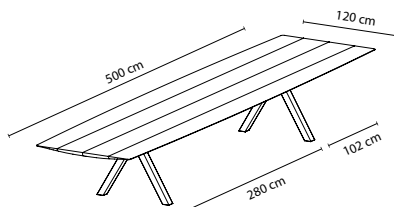

LEGS	Wood / Madera	
TOP	Anodized silver Anodizado plata	10.002
	Laminated Laminado	13.379
	Natural oak Roble natural	

#### PACKAGING

	PCS	DIMENSIONS CM	GROSS KG
Legs / Patas	1	90 x 40 x 80	22
Top / Sobre	1	520 x 20 x 140	255

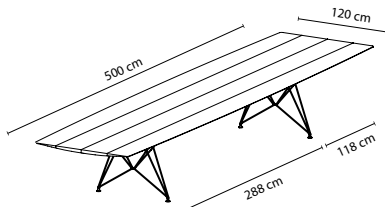

LEGS	Stainless Steel / Acero inoxidable	
TOP	Anodized silver Anodizado plata	9.624
	Laminated Laminado	13.180
	Natural oak Roble natural	

#### PACKAGING

	PCS	DIMENSIONS CM	GROSS KG
Legs / Patas	1	90 x 40 x 80	23
Top / Sobre	1	520 x 20 x 140	255

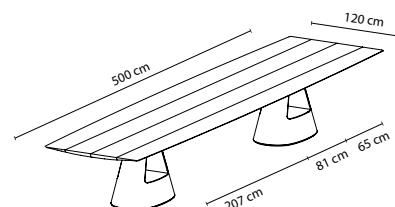

LEGS	Concrete / Hormigón	
TOP	Anodized silver Anodizado plata	11.843
	Laminated Laminado	15.596
	Natural oak Roble natural	

#### PACKAGING

	PCS	DIMENSIONS CM	GROSS KG
Legs / Patas	2	120 x 80 x 85	180
Top / Sobre	1	520 x 20 x 140	255

### LAMINATE RESTRICTIONS LENGTH 360 - 400 - 500 cm / RESTRICCIONES DEL LAMINADO LARGO 360 - 400 - 500 cm

- In the case of the laminated finish, the top is formed by placing the laminates in a patchwork layout for lengths of 360cm, 400cm and 500cm.
- In the case of the natural oak finish, the top is formed by placing the laminates in a patchwork layout for lengths of 400cm and 500cm.
- En los casos de los acabados laminados, el sobre se conforma colocando las láminas cómo un patchwork para longitudes de 360cm, 400 cm y 500 cm.
- En el caso del acabado laminado roble natural, el sobre se conforma colocando las láminas cómo un patchwork para longitudes de 400 cm y 500 cm.

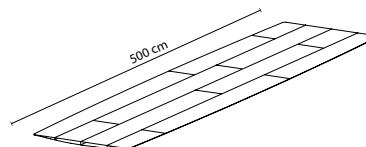
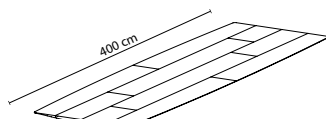
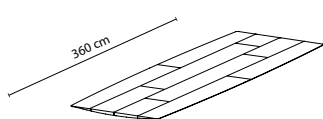



## TABLE B 150 cm

All prices are for the complete table (Top + Legs)  
 Todos los precios son para la mesa completa (Sobre + Patas)

### LENGTH / LONGITUD 300 cm

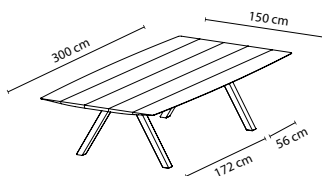

LEGS	Wood / Madera	
	Anodized silver Anodizado plata	8.879
TOP	Laminated Laminado	12.039
	Natural oak Roble natural	

PACKAGING			
	PCS	DIMENSIONS CM	GROSS KG
Legs / Patas	1	90 x 80 x 120	30
Top / Sobre	1	320 x 20 x 170	95

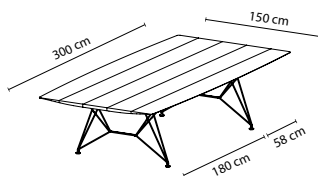

LEGS	Stainless Steel / Acero inoxidable	
	Anodized silver Anodizado plata	8.689
TOP	Laminated Laminado	13.242
	Natural oak Roble natural	

PACKAGING			
	PCS	DIMENSIONS CM	GROSS KG
Legs / Patas	1	90 x 80 x 120	25
Top / Sobre	1	320 x 20 x 170	95

### LENGTH / LONGITUD 360 cm

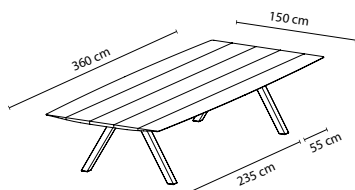

LEGS	Wood / Madera	
	Anodized silver Anodizado plata	9.783
TOP	Laminated Laminado	13.686
	Natural oak Roble natural	

PACKAGING			
	PCS	DIMENSIONS CM	GROSS KG
Legs / Patas	1	90 x 80 x 120	30
Top / Sobre	1	380 x 20 x 170	120

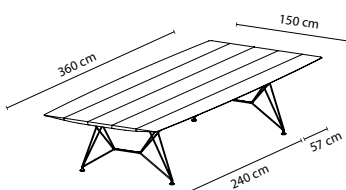

LEGS	Stainless Steel / Acero inoxidable	
	Anodized silver Anodizado plata	9.589
TOP	Laminated Laminado	13.483
	Natural oak Roble natural	

PACKAGING			
	PCS	DIMENSIONS CM	GROSS KG
Legs / Patas	1	90 x 80 x 120	25
Top / Sobre	1	380 x 20 x 170	120

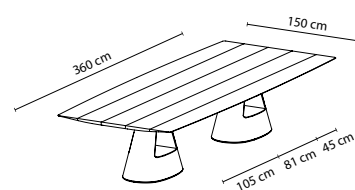

LEGS	Concrete / Hormigón	
	Anodized silver Anodizado plata	12.486
TOP	Laminated Laminado	16.866
	Natural oak Roble natural	

PACKAGING			
	PCS	DIMENSIONS CM	GROSS KG
Legs / Patas	2	120 x 120 x 85	180
Top / Sobre	1	380 x 20 x 170	120

### LENGTH / LONGITUD 400 cm

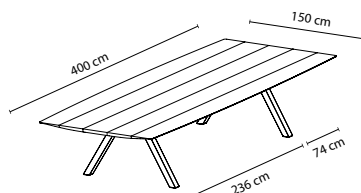

LEGS	Wood / Madera	
	Anodized silver Anodizado plata	10.699
TOP	Laminated Laminado	14.638
	Natural oak Roble natural	

PACKAGING			
	PCS	DIMENSIONS CM	GROSS KG
Legs / Patas	1	90 x 80 x 120	30
Top / Sobre	1	420 x 20 x 170	125

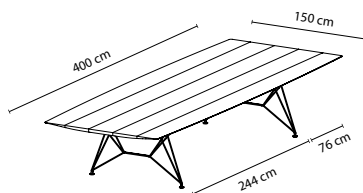

LEGS	Stainless Steel / Acero inoxidable	
	Anodized silver Anodizado plata	10.505
TOP	Laminated Laminado	14.438
	Natural oak Roble natural	

PACKAGING			
	PCS	DIMENSIONS CM	GROSS KG
Legs / Patas	1	90 x 80 x 120	25
Top / Sobre	1	420 x 20 x 170	125

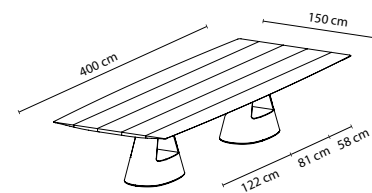

LEGS	Concrete / Hormigón	
	Anodized silver Anodizado plata	13.418
TOP	Laminated Laminado	17.805
	Natural oak Roble natural	

PACKAGING			
	PCS	DIMENSIONS CM	GROSS KG
Legs / Patas	2	120 x 120 x 85	180
Top / Sobre	1	520 x 20 x 140	125

## TABLE B 150 cm

All prices are for the complete table (Top + Legs)  
 Todos los precios son para la mesa completa (Sobre + Patas)

### LENGTH / LONGITUD 500 cm

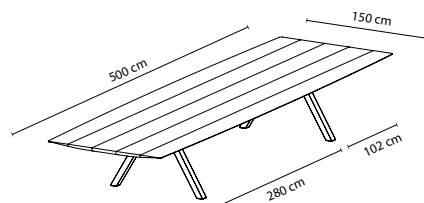

LEGS	Wood / Madera	
	Anodized silver Anodizado plata	12.523
TOP	Laminated Laminado	16.632
	Natural oak Roble natural	

#### PACKAGING

	PCS	DIMENSIONS CM	GROSS KG
Legs / Patas	1	90 x 80 x 120	30
Top / Sobre	1	520 x 20 x 170	150

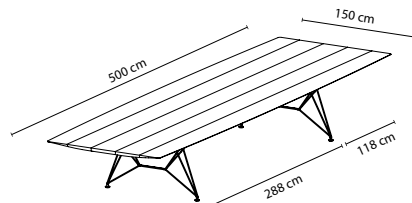

LEGS	Stainless Steel / Acero inoxidable	
	Anodized silver Anodizado plata	12.329
TOP	Laminated Laminado	16.432
	Natural oak Roble natural	

#### PACKAGING

	PCS	DIMENSIONS CM	GROSS KG
Legs / Patas	1	90 x 80 x 120	25
Top / Sobre	1	520 x 20 x 170	150

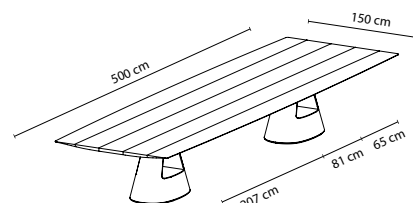

LEGS	Concrete / Hormigón	
	Anodized silver Anodizado plata	15.277
TOP	Laminated Laminado	19.872
	Natural oak Roble natural	

#### PACKAGING

	PCS	DIMENSIONS CM	GROSS KG
Legs / Patas	2	120 x 120 x 85	180
Top / Sobre	1	520 x 20 x 170	150

### LAMINATE RESTRICTIONS LENGTH 360 - 400 - 500 cm / RESTRICCIONES DEL LAMINADO LARGO 360 - 400 - 500 cm

- In the case of the laminated finish, the top is formed by placing the laminates in a patchwork layout for lengths of 360cm, 400cm and 500cm.
- In the case of the natural oak finish, the top is formed by placing the laminates in a patchwork layout for lengths of 400cm and 500cm.
- En los casos de los acabados laminados, el sobre se conforma colocando las láminas cómo un patchwork para longitudes de 360cm, 400 cm y 500 cm.
- En el caso del acabado laminado roble natural, el sobre se conforma colocando las láminas cómo un patchwork para longitudes de 400 cm y 500 cm.

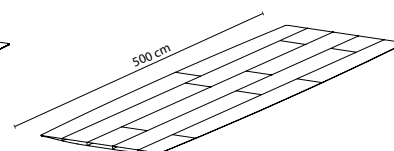
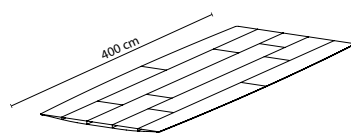
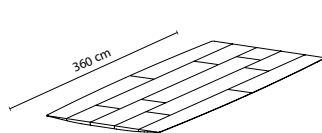
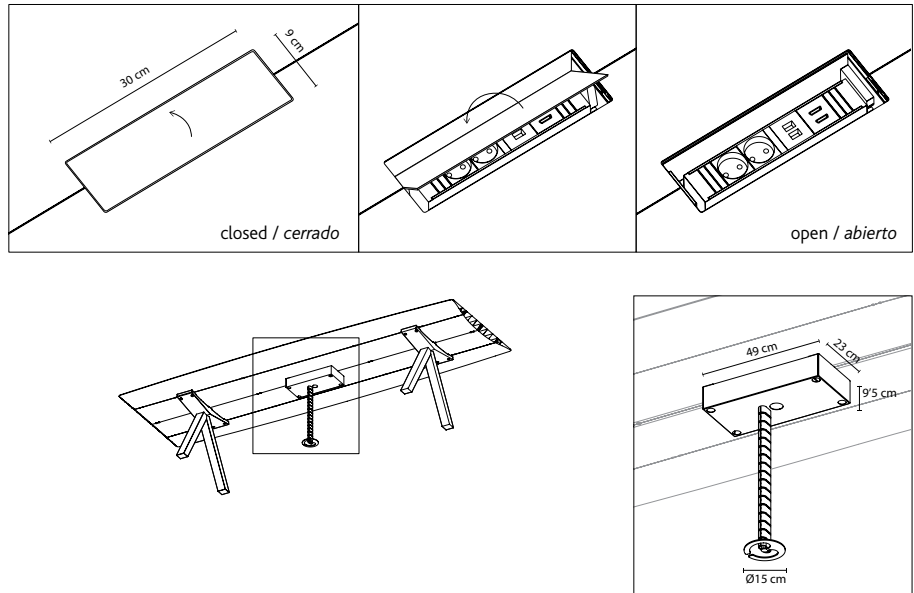

TABLE B ELECTRIC CABLE MANAGEMENT / ELECTRIFICACIÓN (examples on page 52 -53 / ejemplos en pág. 52-53)

1. TOP FRAME ( for Table B 90, 120 & 150)



POWER STRIP KIT INCLUDES  
EL KIT DE ELECTRIFICACIÓN INCLUYE:

- Anodized aluminum case with open-close cover / Caja de aluminio anodizado con tapa plegable
- 2 Schuko Sockets / 2 Enchufes Schuko
- 2 USB connectors / 2 conectores USB
- 2 HDMI connectors / 2 conectores HDMI
- Snake Cable Premium Silver / Cables Premium Plata
- Electric cord / Cable de corriente

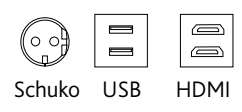

Top frame (per unit / por unidad) 1.981

2. SOCKETS & GROMMETS / ENCHUFES Y PASACABLES (for all models / para todos los modelos)

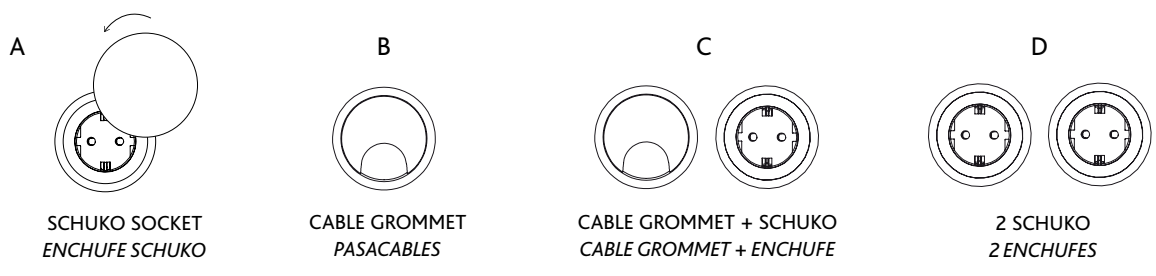

Consult socket type for your country / Consultar enchufes para tu país.

A. 1 Schuko	380
B. 1 Cable Grommet / 1 Pasacables	215
C. 1 Cable Grommet + 1 Schuko / 1 Cable Grommet + 1 Schuko	595
D. 2 Schuko	760

## ELECTRIC CABLE MANAGEMENT EXEMPLES

All prices are for the complete table (Top + Legs + Electrification Kit)  
 Todos los precios son para la mesa completa (Sobre + Patas + Electrificación)

### TABLE B Desk

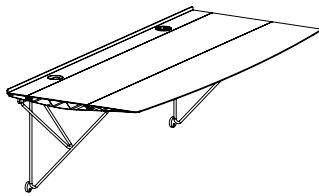

180 x 70 x 50 cm 3.115  
 LEGS / PATAS: Stainless steel (wall) /  
 Acero inoxidable (pared)  
 TOP / SOBRE: Anodized silver /  
 Anodizado plata

1 Schuko 380

1 Grommet / Pasacables 215

TOTAL 3.710



180 x 70 x 74 cm 3.323  
 LEGS / PATAS: Stainless steel /  
 Acero inoxidable  
 TOP / SOBRE: Anodized silver /  
 Anodizado plata

1 Grommet / Pasacables 215

TOTAL 3.538

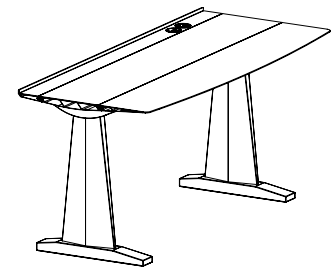

180 x 70 x 74 cm 3.385  
 LEGS / PATAS: Wooden trestle /  
 Caballete madera  
 TOP / SOBRE: Anodized silver /  
 Anodizado plata

1 Grommet + 1 Schuko  
 1 Pasacables + 1 Schuko 595

TOTAL 3.980

### TABLE B 90 cm

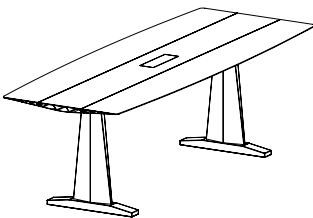

240 x 90 x 74 cm 4.866  
 LEGS / PATAS: Wooden trestle /  
 Caballete madera  
 TOP / SOBRE: Anodized silver /  
 Anodizado plata

Top frame 1.981

TOTAL 6.847



240 x 90 x 74 cm 4.203  
 LEGS / PATAS: Aluminium / Aluminio  
 TOP / SOBRE: Anodized silver /  
 Anodizado plata

1 Schuko 380

TOTAL 4.583

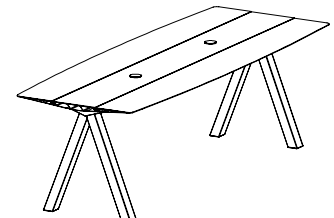

240 x 90 x 74 cm 4.362  
 LEGS / PATAS: Wood / Madera  
 TOP / SOBRE: Anodized silver /  
 Anodizado plata

2 Schuko 760

TOTAL 5.122

# ELECTRIC CABLE MANAGEMENT EXEMPLES

All prices are for the complete table (Top + Legs + Electrification Kit)  
 Todos los precios son para la mesa completa (Sobre + Patas + Electrificación)

## TABLE B 120 cm

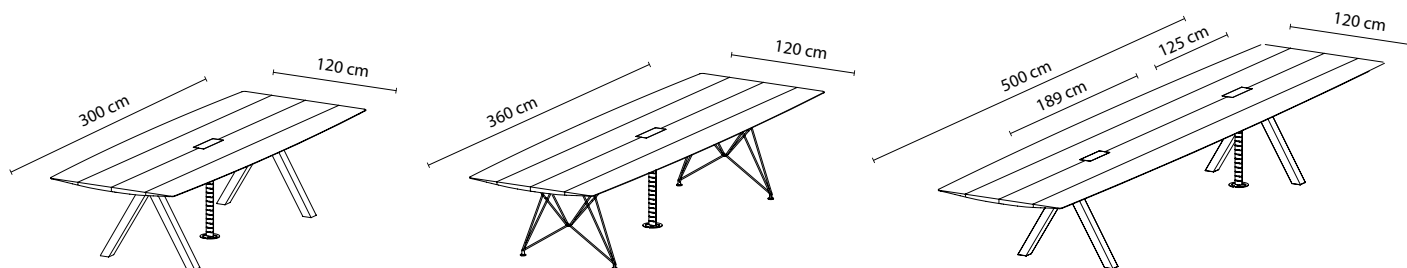

300 x 120 x 74 cm  
 LEGS / PATAS: Wood / Madera  
 TOP / SOBRE: Anodized silver / Anodizado plata

6.437

Top frame 1.981

TOTAL 8.418

360 x 120 x 74 cm  
 LEGS / PATAS: Stainless steel / Acero inoxidable  
 TOP / SOBRE: Anodized silver / Anodizado plata

7.064

Top frame 1.981

TOTAL 9.045

500 x 120 x 74 cm  
 LEGS / PATAS: Wood / Madera  
 TOP / SOBRE: Anodized silver / Anodizado plata

10.002

2 Top frame 3.962

TOTAL 13.964

## TABLE B 150 cm

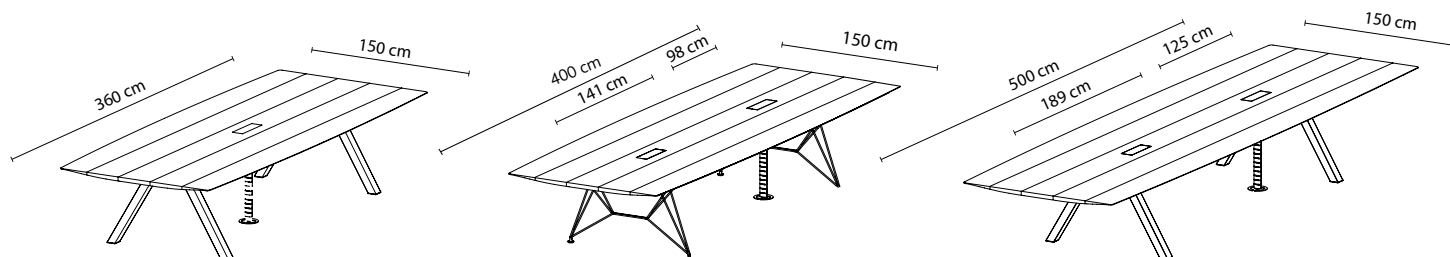

360 x 150 x 74 cm  
 LEGS / PATAS: Wood / Madera  
 TOP / SOBRE: Anodized silver / Anodizado plata

9.783

Top frame 1.981

TOTAL 11.764

400 x 150 x 74 cm  
 LEGS / PATAS: Stainless steel / Acero inoxidable  
 TOP / SOBRE: Anodized silver / Anodizado plata

10.505

2 Top frame 3.962

TOTAL 14.467

500 x 150 x 74 cm  
 LEGS / PATAS: Wood / Madera  
 TOP / SOBRE: Anodized silver / Anodizado plata

12.523

2 Top frame 3.962

TOTAL 16.485

STORAGE AND SHELVING  
ESTANTERÍAS Y CONTENEDORES

TABLES  
MESAS

ARMCHAIRS  
BUTACAS

CHAIRS AND STOOLS  
SILLAS Y TABURETES

ACCESSORIES  
ACCESORIOS

LIGHTING  
ILUMINACIÓN

PUBLIC SEATING  
ASIENTOS PÚBLICOS

ART EDITIONS

## EXPLORER DINING TABLE

Jaime Hayon

Interior painted steel structure. Central leg and base in fibreglass with a gloss (strengthened gel for durability) finish. A MDF veneered table top in Polaris with a matte finish by Abet Laminati. The underside and the borders of the top are lacquered in a matte finish. Nylon leveling glides. Multicolour options for three models. Optional: table top available in Polaris Black.

*Estructura interna de acero pintada. Cuerpo y base en fibra de vidrio lacado en brillo. La base está pintada con gelcoat de alta durabilidad. Sobre en MDF chapado en estratificado Polaris mate de Abet Laminati. Parte inferior y canto van lacados en mate. Tacos reguladores en nylon. 3 opciones multicolor para todos los modelos. Opcionalmente existe la posibilidad de sustituir el color del sobre por un Polaris negro.*

Explorer 4	4.921
Explorer 5A (190 cm)	5.678
Explorer 5B (220 cm)	5.820
Explorer 6 (300 cm)	9.680
Optional Top Polaris 2902 Nearly Black (with underside in Grey 7037) Sobre opcional en Polaris 2902 Negro (con parte inferior en Gris 7037)	+3%

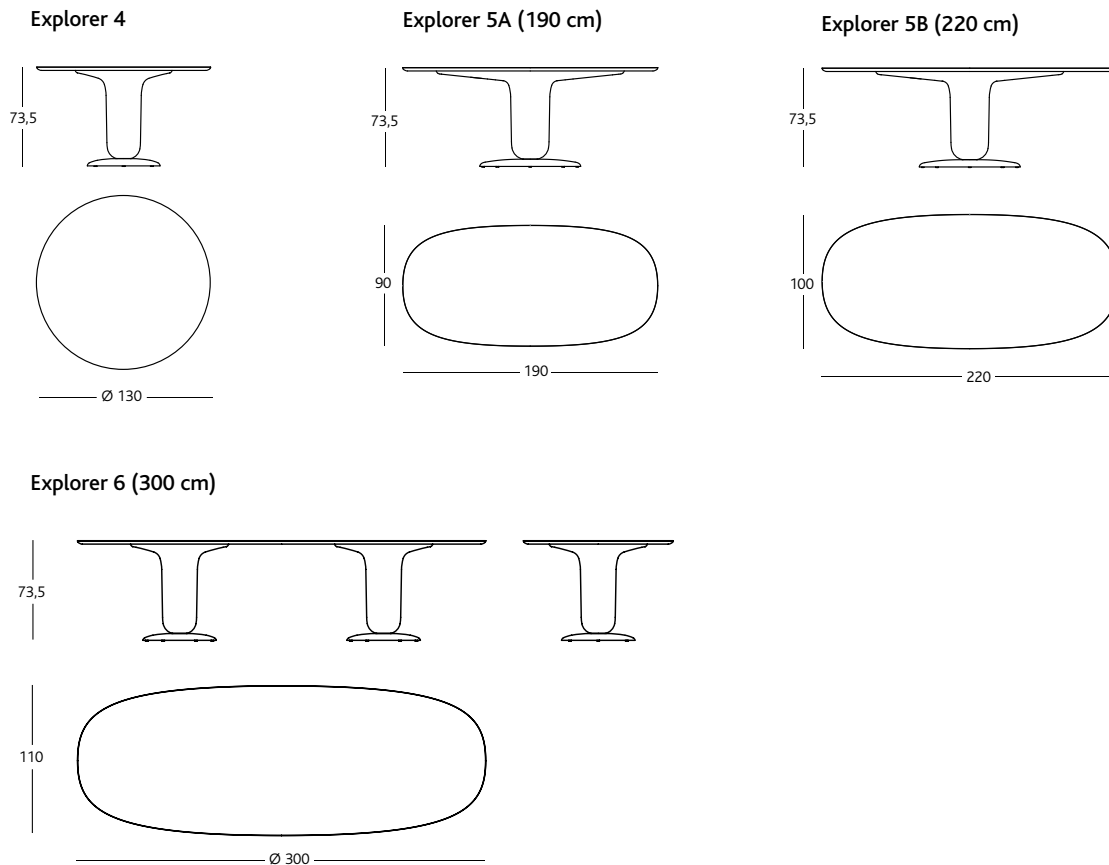

### PACKAGING

Explorer 4			Explorer 5A 190			Explorer 5B 220			Explorer 6 300		
PCS	DIMENSIONS CM	GROSS KG	PCS	DIMENSIONS CM	GROSS KG	PCS	DIMENSIONS CM	GROSS KG	PCS	DIMENSIONS CM	GROSS KG
Leg / Pata	1 87 x 87 x 92	85	Leg / Pata	1 175 x 71 x 92	128	Leg / Pata	1 175 x 71 x 92	128	Leg / Pata	2 87 x 87 x 92	170
Top / Sobre	1 143 x 14 x 143	42	Top / Sobre	1 203 x 14 x 102	49	Top / Sobre	1 232 x 14 x 114	61	Top / Sobre	1 314 x 14 x 125	81



# EXPLORER DINING MODELS & COLOURS / *MODELOS Y COLORES*



**EXP04COL04**  
Explorer 4 - Multicolor Blue

**EXP05ACOL04**  
Explorer 5A 190 - Multicolor Blue

**EXP05BCOL04**  
Explorer 5B 220 - Multicolor Blue

**EXP06COL04**  
Explorer 6 300 - Multicolor Blue

-Laminated top / *Sobre estratificado*: Polaris 2903 (Grey Perle / *Gris perla*)  
 -Underside top / *Sobre parte inferior*: Ral 5008 Mate (Grey blue / *Azul grisáceo*)  
 -Body / *cuerpo*: Ral 5008 Gloss (Grey blue / *Azul grisáceo*)  
 -Base: Ral 1015 Gloss (Light Ivory / *Marfil claro*)



**EXP04COL05**  
Explorer 4 - Multicolor Ivory

**EXP05ACOL05**  
Explorer 5A 190 - Multicolor Ivory

**EXP05BCOL05**  
Explorer 5B 220 - Multicolor Ivory

**EXP06COL05**  
Explorer 6 300 - Multicolor Ivory

-Laminated top / *Sobre estratificado*: Polaris 2903 (Grey Perle / *Gris perla*)  
 -Underside top / *Sobre parte inferior*: Ral 5008 Mate (Grey blue / *Azul grisáceo*)  
 -Body / *cuerpo*: Ral 1015 Gloss (Light Ivory / *Marfil claro*)  
 -Base: Ral 6009 Gloss (Fir green / *Verde abeto*)

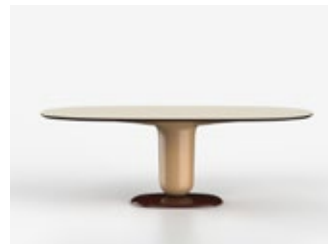
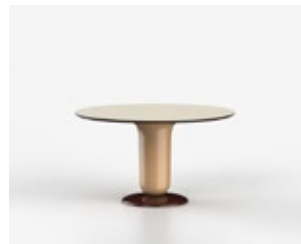

**EXP04COL06**  
Explorer 4 - Multicolor Beige

**EXP05ACOL06**  
Explorer 5A 190 - Multicolor Beige

**EXP05BCOL06**  
Explorer 5B 220 - Multicolor Beige

**EXP06COL06**  
Explorer 6 300 - Multicolor Beige

-Laminated top / *Sobre estratificado*: Polaris 2901 (Sable / *Arena*)  
 -Underside top / *Sobre parte inferior*: Ral 8017 Mate (Chocolate brown / *Marrón chocolate*)  
 -Body / *cuerpo*: Ral 1001 Gloss (Beige)  
 -Base: Ral 8015 Gloss (Chestnut brown / *Marrón castaño*)

Laminated <i>Estratificado</i>	Grey perle / <i>Gris perla</i>
	Sable / <i>Arena</i>
	Nearly Black / <i>Casi negro</i>

## MULTILEG LOW TABLE / MESA BAJA MULTILEG

Jaime Hayon

MDF base top and lacquered high-gloss, matte or veneered in varnished walnut nature effect. Legs in solid turned alder-wood, lacquered in high-gloss or matte or stained in a walnut colour.

Tops: 1cm glass painted, MDF veneered walnut nature effect or 2cm thick marble.

Four finishes available: Matte lacquered (without additional top) / Gloss lacquered with additional glass top / Gloss lacquered with additional marble top / Walnut nature effect (without additional top).

Base en MDF lacado en mate o brillo, o chapado en nogal barnizado efecto nature. Patas en aliso macizo torneado, lacado en mate o brillo, o teñido color nogal. Sobres: vidrio de 1cm pintado, en MDF chapado en nogal barnizado efecto nature o en mármol de 2cm.

Cuatro opciones de acabado: Laca mate (sin sobre adicional) / Laca brillo con sobre adicional de vidrio / Laca brillo con sobre adicional de mármol / Nogal barnizado efecto nature (sin sobre adicional).

### RECTANGULAR 150 x 50 cm

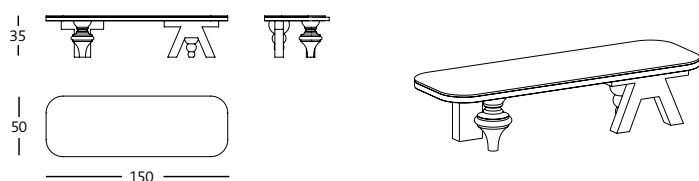

#### PACKAGING

	PCS	DIMENSIONS CM	GROSS KG
Matte & High gloss (glass top) / Mate y Brillante (sobre de vidrio)	1	160x15x60	50
High gloss (marble top) / Brillante (sobre de mármol)	1	160x15x60	85
Walnut top / Sobre de nogal	1	160x15x60	35
4 legs / 4 patas	1	61x60x30	6

All prices are for the complete table (Top + 4 legs)  
Todos los precios son para la mesa completa (Sobre + 4 patas)

<b>Matte / Mate</b> (Glass top not included in this model / Este modelo no incluye sobre de vidrio)	2.132
<b>High Gloss with glass top</b> <i>Lacado brillo con sobre vidrio</i>	2.834
<b>High Gloss with marble top</b> <i>Lacado brillo con sobre mármol</i>	4.318

### ROUND / REDONDA Ø120 cm



#### PACKAGING

	PCS	DIMENSIONS CM	GROSS KG
Matte & High gloss (glass top) / Mate y Brillante (sobre de vidrio)	1	130x15x130	58
High gloss (marble top) / Brillante (sobre de mármol)	1	130x15x130	100
Walnut top / Sobre de nogal	1	130x15x130	38
4 legs / 4 patas	1	61x60x30	6

<b>Matte / Mate</b> (Glass top not included in this model / Este modelo no incluye sobre de vidrio)	2.192
<b>*Walnut / Nogal</b> (Glass top not included in this model / Este modelo no incluye sobre de vidrio)	2.332
<b>High Gloss with glass top</b> <i>Lacado brillo con sobre vidrio</i>	3.016
<b>High Gloss with marble top</b> <i>Lacado brillo con sobre mármol</i>	4.966

\*Until stocks last / Hasta agotar existencias

### RECTANGULAR 160 x100 cm

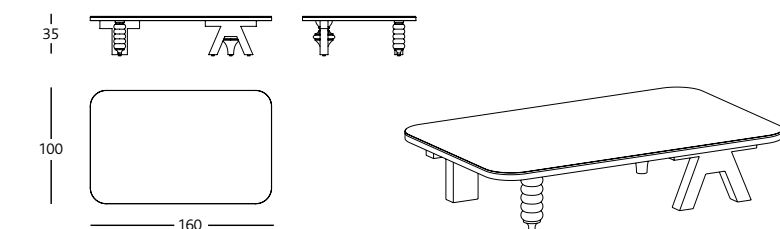

#### PACKAGING

	PCS	DIMENSIONS CM	GROSS KG
Matte & High gloss (glass top) / Mate y Brillante (sobre de vidrio)	1	170x15x110	80
High gloss (marble top) / Brillante (sobre de mármol)	1	170x15x110	140
Walnut top / Sobre de nogal	1	170x15x110	52
4 legs / 4 patas	1	61x60x30	6

<b>Matte / Mate</b> (Glass top not included in this model / Este modelo no incluye sobre de vidrio)	2.253
<b>*Walnut / Nogal</b> (Glass top not included in this model / Este modelo no incluye sobre de vidrio)	2.314
<b>High Gloss with glass top</b> <i>Lacado brillo con sobre vidrio</i>	3.234
<b>High Gloss with marble top</b> <i>Lacado brillo con sobre mármol</i>	4.651

\*Until stocks last / Hasta agotar existencias





LEGS / PATAS

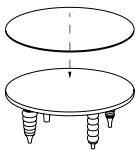
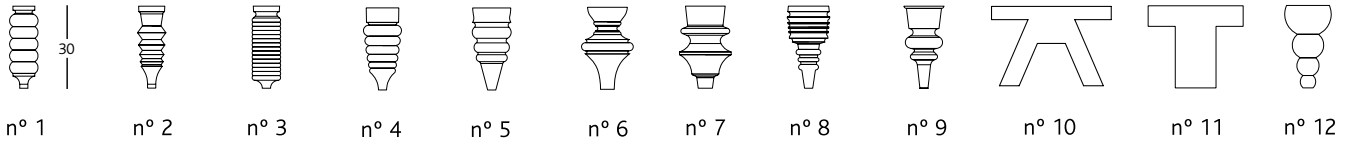

- 1cm thick additional glass top.  
- 2cm thick additional marble top.  
The high gloss models require a top.

- Sobre de vidrio adicional de 1cm de grosor.  
- Sobre de mármol adicional de 2cm de grosor.  
El top es obligatorio en el caso de las mesas con acabado brillante.

LEGS / PATAS	Matte Mate	Gloss Brillo	Walnut Nogal
Unit / Unidad	236	236	295

Each table needs 4 legs / Cada mesa necesita 4 patas

MULTILEG LOW TABLE FINISHES / ACABADOS

<b>High Gloss lacquer</b> <i>Lacas brillo</i>	LAC04 - White / Blanco RAL 9003 LAC09 - Blue / Azul RAL 5002 LAC10 - Black / Negro RAL 9005	<b>High Gloss lacquer</b> <i>Lacas brillo</i>	B31 - White / Blanco RAL 9016 B32 - Blue / Azul RAL 5011 B33 - Green / Verde RAL 6021	NG EN Walnut Nature Effect / Nogal efecto nature
<b>Matte lacquer</b> <i>Lacas mate</i>	LACM04 - White / Blanco RAL 9003 LACM09 - Blue / Azul RAL 5002 LACM10 - Black / Negro RAL 9005	<b>Marble tops</b> <i>Sobre mármol</i>	Green / Verde Patrizia White / Blanco Carrara Venato Black / Negro Marquina	*Custom colour + 10 %. *Color personalizado +10%.

MONKEY SIDE TABLE

Jaime Hayon

Side table manufactured in one solid piece of architectural concrete in different colors. Includes regulatory glides.  
Mesa auxiliar fabricada en una sola pieza de hormigón arquitectónico en diferentes colores. Incorpora tacos reguladores.

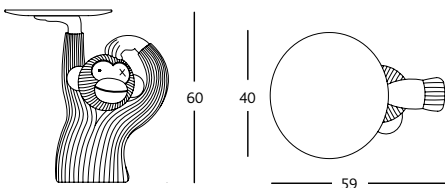

MKSID013	* Grey / gris	(Indoor and outdoor use / uso interior y exterior)	897
MKSID004	White / blanco	(Indoor and outdoor use / uso interior y exterior)	956
MKSID010	Black / negro	(Indoor use only / uso solo interior)	

\*Consult conditions / Consultar condiciones

Request price and delivery time for special colours (pink, yellow, green) min. 4 units.  
Consultar precio y plazo de entrega para colores especiales (rosa, amarillo, verde) min. 4 unidades.

Maximum load on the table is 10 Kg. / Carga máxima encima de la mesa 10 Kg.  
It is recommended not to sit on the tables. / Se recomienda no sentarse encima de las mesas.

Consult price for reinforced packaging. / Consultar precio embalaje reforzado.

PACKAGING			
Standard / Estándar	PCS	DIMENSIONS CM	GROSS KG
Cage / Jaula	1	68 x 54 x 80	33
	1	68 x 54 x 82	40

## SIDE TABLE B

Konstantin Grcic

A solid architectural piece in grey or black. Incorporated with regulatory glides.  
Fabricada de una sola pieza con hormigón arquitectónico gris o negro. Incorpora tacos.

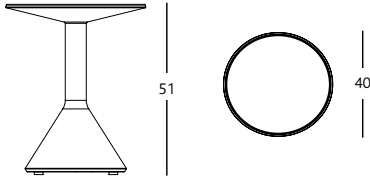

TBSIDE013	<b>Grey / Gris</b> (indoor and outdoor use / uso interior y exterior)	555
TBSIDE010	<b>Black / Negro</b> (indoor use only / uso solo interior)	603

Maximum load on the table is 10 Kg. / Carga máxima encima de la mesa 10 Kg.  
It is recommended not to sit on the tables. / Se recomienda no sentarse encima de las mesas.

PACKAGING		
PCS	DIMENSIONS CM	GROSS KG
1	43 x 43 x 54	15

## 2001 SIDE TABLES

Ramón Úbeda & Otto Canalda

Ultra-clear tempered glass top and a pyrex tube leg, both with a mirrored finish.  
Sobre de vidrio ultraclaro templado con acabado espejado. Pie de tubo de pyrex con acabado espejado.

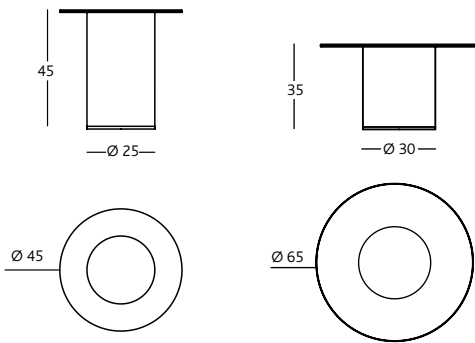

2001SIDE45	<b>H. 45 cm</b>	1.210
2001SIDE35	<b>H. 35 cm</b>	1.689

Maximum load on the table is 8 Kg. / Carga máxima encima de la mesa 8 Kg.  
It is recommended not to sit on the tables. / Se recomienda no sentarse encima de las mesas.

PACKAGING			
	PCS	DIMENSIONS CM	GROSS KG
N.1: Ø65 x h.45 cm	1	51 x 51 x 58	12
N.2: Ø65 x h.35 cm	1	71 x 71 x 48	22

## EXPLORER SIDE TABLE / MESA AUXILIAR

Jaime Hayon

A laquered fibreglass body with matte and gloss finishes. Solid alder-wood legs, lacquered in a matte finish and glass top painted in dark grey.  
Cuerpo de fibra de vidrio lacado mate y brillante. Patas de madera de aliso lacadas mate. Sobre de cristal pintado gris negruzco.

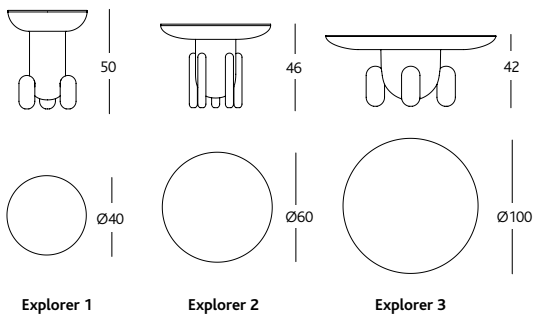

	Monocolor	Multicolor V1 / V2
<b>Explorer 1</b>	1.428	1.507
<b>Explorer 2</b>	1.826	1.970
<b>Explorer 3</b>	2.399	2.575



EXPLORER MODELS & COLOURS / *MODELOS Y COLORES***EXP01COL01****Explorer 1 - Multicolor Green / Verde - V1**

- Glass / Cristal: Ral 7021
- Top / Sobre: Ral 7001 Mate
- Middle / Medio: Ral 6005 Gloss
- Legs / Patas: Ral 3012 Mate

**EXP02COL01****Explorer 2 - Multicolor Dark Blue / Azul oscuro - V1**

- Glass / Cristal: Ral 7021
- Top / Sobre: Ral 5002 Mate
- Middle / Medio: Ral 5004 Gloss
- Legs / Patas: Ral 1019 Mate

**EXP03COL01****Explorer 3 - Multicolor Red / Rojo - V1**

- Glass / Cristal: Ral 7021
- Top / Sobre: Ral 3012 Mate
- Middle / Medio: Ral 3011 Gloss
- Legs / Patas: Ral 7006 Mate

**EXP01COL02****Explorer 1 - Multicolor Beige - V2**

- Glass / Cristal: Ral 7021
- Top / Sobre: Ral 5007 Mate
- Middle / Medio: Ral 1019 Gloss
- Legs / Patas: Ral 5003 Mate

**EXP02COL02****Explorer 2 - Multicolor Brown / Marrón - V2**

- Glass / Cristal: Ral 7021
- Top / Sobre: Ral 1001 Mate
- Middle / Medio: Ral 8011 Gloss
- Legs / Patas: Ral 8004 Mate

**EXP03COL02****Explorer 3 - Multicolor Grey / Gris - V2**

- Glass / Cristal: Ral 7021
- Top / Sobre: Ral 7001 Mate
- Middle / Medio: Ral 7001 Gloss
- Legs / Patas: Ral 6028 Mate

**EXP01MON01****Explorer 1 - Monocolor Dark Grey / Gris oscuro**

- Glass / Cristal: Ral 7021
- Body / Cuerpo: Ral 7021 Gloss
- Legs / Patas: Ral 7021 Mate

**EXP02MON01****Explorer 2 - Monocolor Dark Grey / Gris oscuro**

- Glass / Cristal: Ral 7021
- Body / Cuerpo: Ral 7021 Gloss
- Legs / Patas: Ral 7021 Mate

**EXP03MON01****Explorer 3 - Monocolor Dark Grey / Gris oscuro**

- Glass / Cristal: Ral 7021
- Body / Cuerpo: Ral 7021 Gloss
- Legs / Patas: Ral 7021 Mate

**EXP01MON02****Explorer 1 - Monocolor Light Grey / Gris claro**

- Glass / Cristal: Ral 7021
- Body / Cuerpo: Ral 7044 Gloss
- Legs / Patas: Ral 7044 Mate

Maximum load on each table / *Carga máxima sobre cada mesa:*

- Explorer 1: 8 kg max.
- Explorer 2: 10 kg max.
- Explorer 3: 12 kg max.

BD recommends not to sit on the tables.

*BD recomienda no sentarse encima de las mesas.*

	PACKAGING		
	PCS	DIMENSIONS CM	GROSS KG
Explorer 1	1	68 x 56 x 70	21
Explorer 2	1	80 x 70 x 66	24
Explorer 3	1	120 x 110 x 62	42

# ARMCHAIRS / BUTACAS

## DINO ARMCHAIR / BUTACA

Jaime Hayon

A rigid polyurethane structure covered with polyether foam cushioning and polyether foam headrest, seat cushion and backrest. Upholstered in different fabrics and leathers provided by BD. Steel legs in a dark bronze colour.

**Hayon Edition:** Two colours available: dark red or green in a combination of Steelcut 2 and Vidar 3 fabric by Kvadrat and Florida leather with armrests in the same colour. Cast aluminium legs painted in a powder coating in the same colour.

*Cuerpo en inyección de poliuretano rígido, con estructura interior de acero tapizado. Cojines tapizados en los diferentes tejidos y pieles de BD. Patas de acero en color bronce oscuro.*

**Hayon Edition:** dos opciones de color: burdeos y verde, combinando tejidos Steelcut 2 y Vidar 3 de Kvadrat y piel Florida a tono para los brazos. Patas en fundición de aluminio pintado en polvo a tono.

	Fabrics / Telas					Leather / Piel	
	*COM	CAT 1	CAT 2	CAT 3	CAT 4	S	V
Dino	2.849	3.124	3.244	3.401	3.554	4.305	4.525
Dino Hayon Edition	4.799						
Aluminium leg / Pata aluminio	244						

\*COM : Customer's own material / Tejido o piel del cliente  
 Metres of material required / Metros de material requerido  
 Fabric / Tela 500 x140cm - Leather / Piel 7m<sup>2</sup>

Customize your own version with our online configurator  
 Personaliza tu propia versión con nuestro configurador online  
[www.bdbarcelona.com](http://www.bdbarcelona.com)

Dino

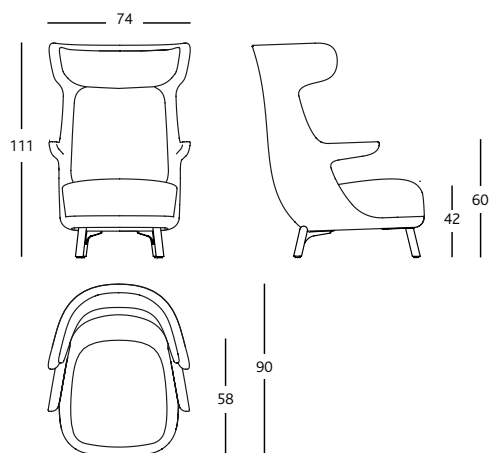

Steel leg / Pata acero (included / incluida)



Aluminium leg / Pata aluminio (optional / opcional)

Dino Hayon Edition

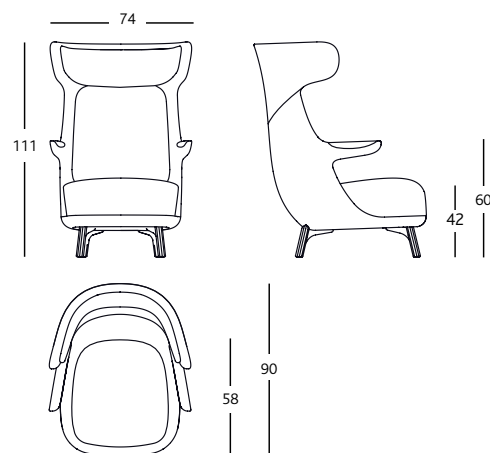

Aluminium leg / Pata aluminio (included / incluida)

### PACKAGING

PCS	DIMENSIONS CM	GROSS KG
1	98 x 82 x 132	43



## GRASSO ARMCHAIR AND FOOTSTOOL / BUTACA Y REPOSAPIÉS

Stephen Burks

Tubular steel structure painted in polyester. Upholstered seat and backrest in different leathers and fabrics provided by BD.  
Footstool in tubular steel structure painted in polyester. Upholstered in different leathers and fabrics provided by BD.  
The wrinkles on the surface are part of the original design. Both the number and size of the wrinkles can vary as natural leathers are being used.  
The elasticity itself enhances the diversity and variability of the wrinkles.

*Estructura de tubo de acero pintado en poliéster, asiento y respaldo tapizados con las distintas pieles y tejidos de BD.*

*Reposapiés con estructura de tubo de acero pintado en poliéster, tapizado con las distintas pieles y tejidos de BD.*

*Las arrugas producidas en la superficie son originales del propio diseño. Tanto el número de arrugas como el tamaño pueden variar debido a utilizar pieles naturales. La propia elasticidad potencia la diversidad y variabilidad de las arrugas.*

	Fabrics / Telas					Leather / Piel		
	*COM	CAT 1	CAT 2	CAT 3	CAT 4	P	S	V/F
Armchair / butaca	2.639	2.830	2.976	3.152	3.328	3.374	3.750	3.878
Footstool / reposapiés	949	958	981	994	1.066	1.159	1.266	1.306

\*COM : Customer's own material / Tejido o piel del cliente

**Metres of material required / Metros de material requerido**

Armchair / butaca: Leather / Piel 7m<sup>2</sup> - Fabric / Tela 550 x 140 cm

Footstool / reposapiés: Leather / Piel 1,5m<sup>2</sup> - Fabric / Tela 150 x 140 cm

Customize your own version with our online configurator  
Personaliza tu propia versión con nuestro configurador online  
[www.bdbarcelona.com](http://www.bdbarcelona.com)

<b>Structure colour</b>	RAL 3013 red / rojo
<b>Color estructura</b>	RAL 7022 gris oscuro / dark grey
	RAL 5011 blue / azul
	RAL 9011 black / negro

## Armchair / butaca

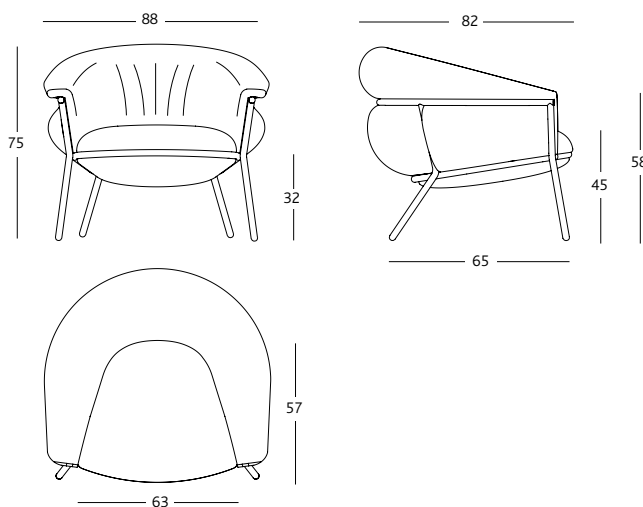

## Footstool / reposapiés

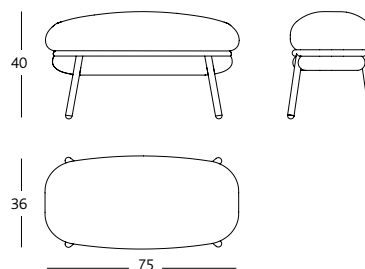

See matching stool on page 85 / Ver taburete a juego en página 85

NYC X DESIGN  
NYC X DESIGN AWARDS 2019



2020 ADI-FAD GOLD DELTA

## PACKAGING

	PCS	DIMENSIONS CM	GROSS KG
Armchair / butaca	1	94 x 91 x 91	36
Footstool / reposapiés	1	74 x 43 x 43	8

## LITTLE COUTURE

Färg & Blanche

Solid wooden seat structure and upholstered. Exterior backrest made up of two birch plywood pieces sewn together and stained in a degraded colour. Upholstered in different materials and leathers provided by BD. Optional swivel system.

Estructura del asiento en madera de haya maciza, tapizada. Respaldo en madera contrachapada de abedul, teñido con un degradado de color, formado por dos piezas cosidas entre sí con hilo de poliamida. Tapizado no desenfundable en los diferentes tejidos y pieles de BD. Sistema giratorio opcional.

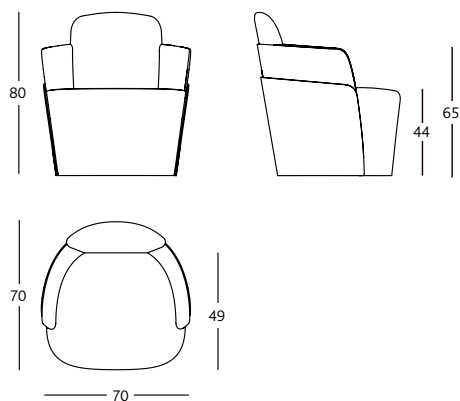

	Fabrics / Telas					Leather / Piel		
	*COM	CAT 1	CAT 2	CAT 3 / Y	CAT 4	P	S	V/F
Little Couture	2.714	2.843	2.879	2.938	2.997	3.156	3.274	3.399

Swivel System +357  
Sistema giratorio

\*COM : Customer's own material / Tejido o piel del cliente

Metres of material required / Metros de material requerido  
Fabric / Tela 150 x 140 cm - Leather / Piel 3 m<sup>2</sup>

### PACKAGING

PCS	DIMENSIONS CM	GROSS KG
1	100 x 83 x 100	30

## COUTURE ARMCHAIR / BUTACA

Färg & Blanche

Solid wooden structure and upholstered seat. Birch plywood backrest made up of pieces sewn together with a polyamide thread and stained in a degraded color or in walnut nature effect. Upholstered in different leathers or fabrics provided by BD. Optional swivel system.

Estructura del asiento en madera maciza tapizada. Respaldo en madera contrachapada de abedul, teñido con un degradado de color o nogal formada por piezas cosidas entre ellas con hilo de poliamida. Tapizado en los diferentes tejidos y pieles de BD. Incorpora la posibilidad de sistema giratorio.

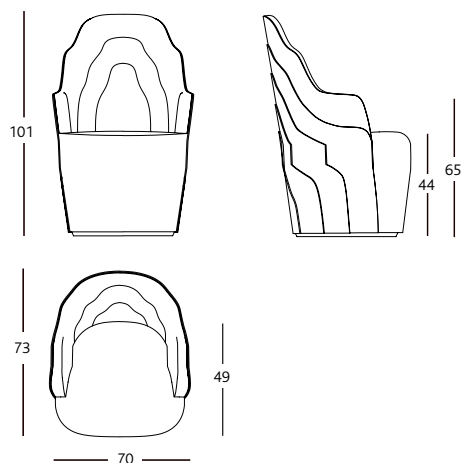

	Fabrics / Telas					Leather / Piel		
	*COM	CAT 1	CAT 2	CAT 3 / Y	CAT 4	P	S	V/F
Degraded birch / Abedul degradado	3.467	3.527	3.574	3.633	3.692	4.121	4.212	4.415
Walnut nature effect / Nogal efecto nature	3.030	3.085	3.129	3.183	3.237	3.629	3.715	3.898

(Until stocks last / hasta agotar existencias)

Swivel System +357  
Sistema giratorio

\*COM : Customer's own material / Tejido o piel del cliente

Metres of material required / Metros de material requerido  
Fabric / Tela 250 x 140 cm - Leather / Piel 4 m<sup>2</sup>

### PACKAGING

PCS	DIMENSIONS CM	GROSS KG
1	100 x 83 x 120	38



## SHOWTIME POLTRONA INDOOR / INTERIOR

Jaime Hayon

Armchair, sofa and cover in rotomoulded polyethylene lacquered in gloss.  
Seat and backrest with flexible polyurethane foam and capitoné upholstery.

Sillón, sofá y capota fabricadas en una sola pieza en polietileno de media densidad (MDPE) rotomoldeado lacado brillo.  
Asiento y respaldo con espuma de poliuretano flexible con tapicería capitoné.

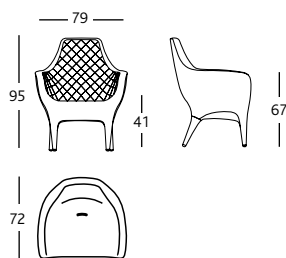

Armchair  
*Poltrona*

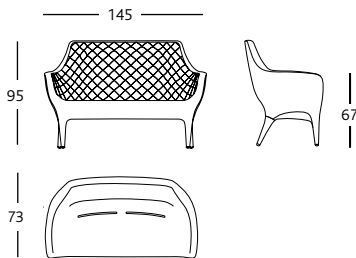

Sofa

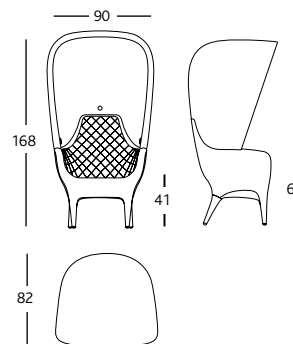

Armchair + Cover  
*Poltrona + Capota*

P

Armchair / *Poltrona*

3.917

Sofa

6.693

Armchair + Cover / *Poltrona + Capota*

7.457

## COLOURS / COLORES

GLOSS LACQUER / LACA BRILLO

LAC04 - White / Blanco RAL 9003

LAC10 - Black / Negro RAL 9005

## PACKAGING

	PCS	DIMENSIONS CM	GROSS KG
Armchair / <i>Poltrona</i>	1	80 x 90 x 110	40
Sofa	1	80 x 155 x 110	60
Poltrona+Cover / <i>Poltrona + Capota</i>	1	90 x 100 x 190	56

## LOUNGER

Jaime Hayon

Armchair with a cast aluminium base structure and footstool with tubular steel legs and painted. Seat, backrest and footstool in plywood and veneered in beech wood. Also available in other finishes: natural ash, ash stained oak or ash stained black and walnut, nature effect. Also available in a single colour, lacquered in red RAL 3004 (LAC M19) and Fusion Granat (TF122) material.

Decorative metal buttons coated in the same finish as the structure. Armrests, seat, backrest and footstool upholstered in different materials and leathers provided by BD.

Estructura de la butaca en fundición de aluminio y reposapiés en tubo de acero pintado. Asiento, respaldo y reposapiés en madera contrachapada de haya. Existen diferentes acabados: fresno natural, fresno teñido color roble, fresno teñido negro y nogal efecto nature. También existe una versión monocolor en rojo RAL 3004 (LAC M19) y tejido Fusion Granate (TF122). Botones embellecedores metálicos en el mismo acabado de la estructura. Brazos, asiento, respaldo y reposapiés tapizados en los diferentes tejidos y pieles de BD.

WALNUT / NOGAL ASH / FRESNO	*COM	CAT 1	CAT 2	CAT 3 / Y	CAT 4	P	S	V/F
Armchair / Butaca	3.522	3.580	3.636	3.704	3.751	4.226	4.414	4.841
Footstool / Reposapiés	1.212	1.286	1.310	1.333	1.356	1.455	1.489	1.639

MONOCOLOR RED / ROJO	CAT 3
Armchair / Butaca	3.799
Footstool / Reposapiés	1.485

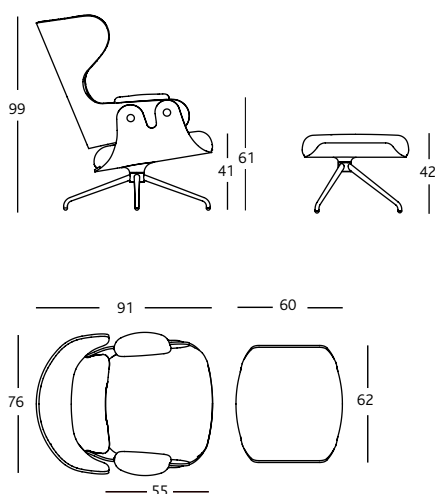

\*COM : Customer's own material / Tejido o piel del cliente

Metres of material required / Metros de material requerido

Lounger: Fabric / Tela 240 x140cm - Leather / Piel 3,7m<sup>2</sup>

Footstool / Reposapiés: Fabric / Tela 85 x140cm - Leather / Piel 1,2m<sup>2</sup>

Customize your own version with our online configurator  
Personaliza tu propia versión con nuestro configurador online  
[www.bdbarcelona.com](http://www.bdbarcelona.com)

### LOUNGER FINISHES / ACABADOS LOUNGER

#### WOOD / MADERA

Walnut Nature Effect / Nogal Efecto Nature NGEN  
Natural ash / Fresno natural FR13  
Ash stained oak / Fresno teñido roble FT18  
Ash stained black / Fresno teñido negro FT10

#### COLOUR OF STRUCTURE / COLOR DE ESTRUCTURA

Anthracite grey / Gris antracita (RAL 7021 matte)  
Pale brown / Marrón claro (RAL 8025 matte)  
Beige (RAL 1001 matte)

#### FABRICS AND LEATHER / TELAS Y PIELS

CAT 1 Libra  
CAT 2 Iris & Gaudí  
CAT 3 Fusion  
CAT 4 Moss  
Y - Medley  
P - Panama  
S - Sauvage  
V - Vintage  
F - Florida

#### MONOCOLOUR RED / MONOCOLOR ROJO

#### LACQUER / LACA

LAC19 Red / Rojo RAL 3004

#### FABRIC

Fusion TF122

#### PACKAGING

	PCS	DIMENSIONS CM	GROSS KG
Armchair / Butaca	1	100 x 83 x 150	43
Footstool / Reposapiés	1	66 x 68 x 52	8





## LOW LOUNGER

Jaime Hayon

Armchair with a cast aluminium tubular base structure and a powder coated finish. Seat and backrest in plywood with surfaces in walnut nature effect, natural ash, ash stained oak and ash stained black.

Decorative metal buttons coated in the same finish as the structure. Armrests, seat and backrest upholstered in different fabrics and leathers provided by BD. Optional footstool (same as Lounger).

*Estructura de la butaca en fundición de aluminio. Asiento y respaldo en madera contrachapada con caras exteriores en nogal efecto nature, fresno natural, fresno teñido roble, fresno teñido negro. Botones embellecedores metálicos en el mismo acabado de la estructura. Brazos, asiento y respaldo tapizados en los diferentes tejidos y pieles de BD.*

## 4 legs / Estructura 4 patas

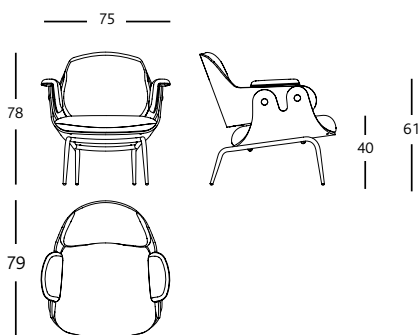

WALNUT / NOGAL ASH / FRESNO	Fabrics / Telas					Leather / Piel		
	*COM	CAT 1	CAT 2	CAT 3/Y	CAT 4	P	S	V/F
4 legs / 4 patas	2.711	2.736	2.753	2.776	2.905	3.116	3.261	3.321
Swivel / Giratoria	3.114	3.126	3.154	3.178	3.317	3.519	3.628	3.724

\*COM : Customer's own material / Tejido o piel del cliente

Metres of material required / Metros de material requerido  
Fabric / Tela 220 x140cm - Leather / Piel 3,5m<sup>2</sup>

## Swivel / Estructura Giratoria

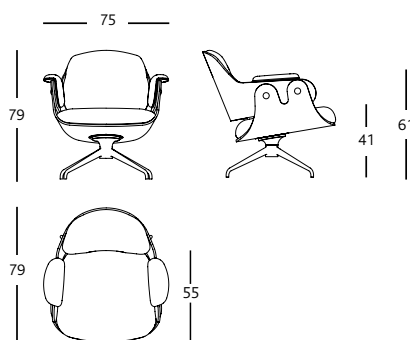

Customize your own version with our online configurator  
Personaliza tu propia versión con nuestro configurador online  
[www.bdbarcelona.com](http://www.bdbarcelona.com)

## LOW LOUNGER FINISHES / ACABADOS LOW LOUNGER

## WOOD / MADERA

Walnut Nature Effect / Nogal Efecto Nature NG EN  
Natural ash / Fresno natural FR 13  
Ash stained oak / Fresno teñido roble FT18  
Ash stained black / Fresno teñido negro FT10

## COLOUR OF STRUCTURE / COLOR DE ESTRUCTURA

Anthracite grey / Gris antracita (RAL 7021 matte)  
Pale brown / Marrón claro (RAL 8025 matte)  
Beige (RAL 1001 matte)

## FABRICS AND LEATHER / TELAS Y PIELES

CAT 1 Libra  
CAT 2 Iris & Gaudí  
CAT 3 Fusion  
CAT 4 Moss  
Y - Medley  
P - Panama  
S - Sauvage  
V - Vintage  
F - Florida

	PACKAGING		
	PCS	MEDIDAS CM	BRUTO KG
Low Lounger Swivel / Giratorio	1	88 x 83 x 100	35
Low lounger 4 legs / 4 patas	1	88 x 83 x 100	26
Footstool / Reposapiés	1	66 x 68 x 52	8

# GARDENIAS COLLECTION

## GARDENIAS OUTDOOR

Jaime Hayon

Structure in aluminium and laminates in extruded aluminium. Powder coating in white (RAL 9001), grey (RAL 7015) or green (RAL 6021). Detachable upholstered cushions; Covers are removable for washing; Apt for outdoors with water-repellent foam.

Estructura fabricada en fundición y laminas en extrusión de aluminio. Pintadas en blanco (RAL 9001), gris (RAL 7015) o verde (RAL 6021). Tapicería desmontable, desenfundable y con tejido apto para exterior y espuma hidrófuga.

### ARMCHAIR / SILLÓN

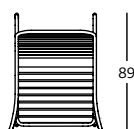
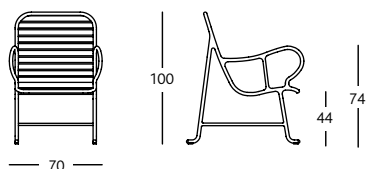

GARSIND04	White / blanco	1.424
GARSIND16	Green / verde	1.424
GARSIND13	Grey (cool effect) / Gris (efecto cool)	1.558

Outdoor cushions / Cojines outdoor  
(GAMA fabrics / Tejidos GAMA) 384

### BENCH / SOFÁ (Until stocks last / hasta agotar existencias)

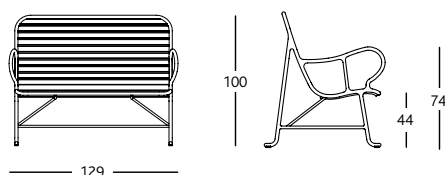

GARSDOB04	White / blanco	2.150
GARSDOB16	Green / verde	2.150
GARSDOB13	Grey (cool effect) / Gris (efecto cool)	2.346

Outdoor cushions / Cojines outdoor  
(GAMA fabrics / Tejidos GAMA) 714

### ARMCHAIR WITH PERGOLA / SILLÓN CON PÉRGOLA

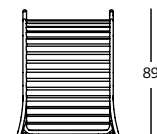
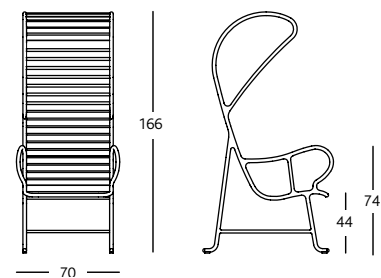

GARSPER04	White / blanco	2.541
GARSPER16	Green / verde	2.541
GARSPER13	Grey (cool effect) / Gris (efecto cool)	2.622

Outdoor cushions / Cojines outdoor  
(GAMA fabrics / Tejidos GAMA) 384

#### PACKAGING

	PCS	DIMENSIONS CM	GROSS KG
Armchair / Sillón	1	100 x 82 x 112	26
Bench / Sofá	1	155 x 100 x 112	53
Armchair with pergola / Sillón con pérgola	1	100 x 90 x 188	40



Delta Silver Award 2014 / Premio Delta Plata 2014



## GARDENIAS INDOOR

Jaime Hayon

Structure in cast aluminium and laminates in extruded aluminium. Powder coating in Alesta Anodic Black or in high-gloss yellow (RAL 1005).  
Seat and backrest upholstered in different fabrics and leathers provided by BD. Piping in the same colour as the structure.

Estructura fabricada en fundición y laminas en extrusión de aluminio. Pintada en polvo en Anodic Black o en Amarillo brillante (RAL 1005).  
Asiento y respaldo tapizados en los diferentes tejidos y pieles de BD. Ribete del mismo color de la estructura.

## ARMCHAIR / SILLÓN

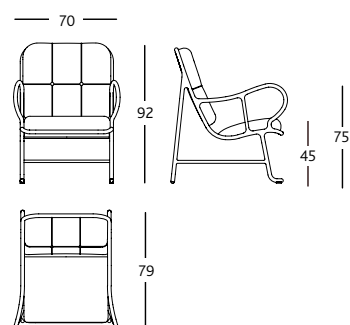

*COM	Fabrics / Telas				Leather / Piel		
	CAT 1	CAT 2	CAT 3 / Y	CAT 4	P	S	V/F
2.507	2.516	2.522	2.528	2.584	2.740	2.857	2.892
				F			
Monochrome structure and yellow leather Estructura monocolor y piel en amarillo				3.068			

\*COM : Customer own material / material del cliente

Metres of material required / Metros de material requerido  
Fabric 80 x 140 cm - Leather 1,67m<sup>2</sup> / Tela 80 x 140 cm - Piel 1,67m<sup>2</sup>

Customize your own version with our online configurator  
Personaliza tu propia versión con nuestro configurador online  
[www.bdbarcelona.com](http://www.bdbarcelona.com)

## BENCH / SOFÁ

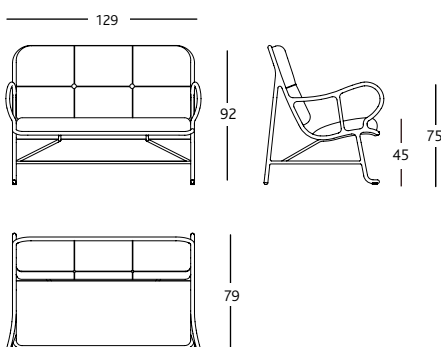

*COM	Fabrics / Telas				Leather / Piel		
	CAT 1	CAT 2	CAT 3 / Y	CAT 4	P	S	V/F
3.963	3.909	3.952	4.150	4.204	4.289	4.350	4.543
				F			
Monochrome structure and yellow leather Estructura monocolor y piel en amarillo				4.982			

\*COM : Customer own material / material del cliente

Metres of material required / Metros de material requerido  
Fabric 360 x 140 cm - Leather 2,5m<sup>2</sup> / Tela 360 x 140 cm - Piel 2,5m<sup>2</sup>

## ARMCHAIR WITH PERGOLA / SILLÓN CON PÉRGOLA

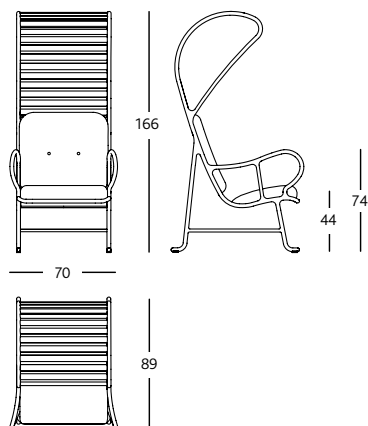

*COM	Fabrics / Telas				Leather / Piel		
	CAT 1	CAT 2	CAT 3 / Y	CAT 4	P	S	V/F
4.059	4.115	4.150	4.286	4.342	4.376	4.342	4.467
				F			
Monochrome structure and yellow leather Estructura monocolor y piel en amarillo				4.779			

\*COM : Customer own material / material del cliente

Metres of material required / Metros de material requerido  
Fabric 180 x 140 cm - Leather 1,67m<sup>2</sup> / Tela 180 x 140 cm - Piel 1,67m<sup>2</sup>

## PACKAGING

	PCS	DIMENSIONS CM	GROSS KG
Armchair / Sillón	1	100 x 82 x 112	26
Bench / Sofá	1	155 x 100 x 112	53
Armchair with pergola / Sillón con pérgola	1	100 x 90 x 188	40

## DALILIPS

Salvador Dalí

A two-seat sofa made of polyethylene with a rotational moulding process in red.  
Sofá de dos plazas realizado en polietileno rotomoldeado en masa. Color Rojo Bermellón.

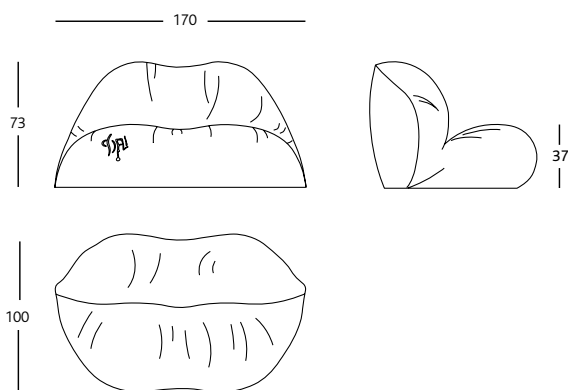

FOR INDOOR AND OUTDOOR USE / PARA USO EXTERIOR - INTERIOR

DA1006 **Red / Rojo (Pantone 200C)** 2.113

Rotomolded Plastic.  
Plástico rotomoldeado.

National transport included. Transport outside of Spain not included.  
Transporte nacional incluido. Transporte fuera de España no incluido.

Extra packaging wooden box (consult price).  
Packing extra en caja madera (consultar precio).

© SALVADOR DALÍ / FUNDACIÓN GALA-SALVADOR DALÍ, BARCELONA, 2022

PACKAGING

PCS	DIMENSIONS CM	GROSS KG
1	175 x 110 x 95	35

## GAULINO EASY CHAIR / SILLONCITO

Oscar Tusquets

3 different finishes:

Structure and backrest in natural varnished ash. Seat upholstered in natural hide.

Structure and backrest in open pore lacquered ash in black. Seat upholstered in black hide.

Structure and backrest in open pore open lacquered ash in coral red (RAL 3016). Seat upholstered in toasted hide.

3 acabados diferentes:

Estructura y respaldo en fresno macizo natural barnizado. Asiento tapizado en cuero natural.

Estructura y respaldo en fresno lacado a poro abierto en negro. Asiento tapizado en cuero negro.

Estructura y respaldo en fresno lacado a poro abierto en rojo coral (RAL 3016). Asiento tapizado en cuero tostado.

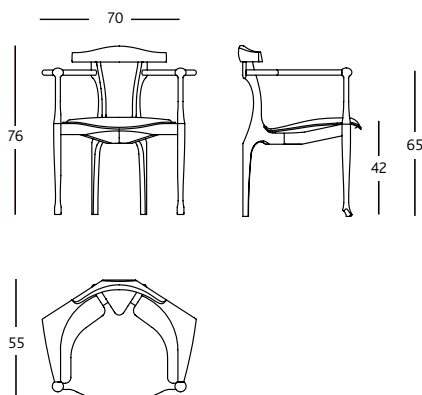

GAUBUFR13C13	<b>Natural</b>	
GAUBUFR10C10	<b>Black / Negro</b>	1.654
GAUBUFR20C20	<b>Coral red / Rojo coral</b>	

Soft felt glides included. See page 18 / Tacos de fieltro incluidos. Ver página 18

PACKAGING

PCS	DIMENSIONS CM	GROSS KG
1	78 x 84 x 83	13



## CHAIRS AND STOOLS / SILLAS Y TABURETES

### GAULINETTA CHAIR / SILLA

Oscar Tusquets

3 different finishes:

Structure and backrest in natural varnished ash. Seat upholstered in natural hide.

Structure and backrest in open pore lacquered ash in black. Seat upholstered in black hide.

Structure and backrest in open pore open lacquered ash in coral red (RAL 3016). Seat upholstered in toasted hide.

3 acabados diferentes:

Estructura y respaldo en fresno macizo natural barnizado. Asiento tapizado en cuero natural.

Estructura y respaldo en fresno lacado a poro abierto en negro. Asiento tapizado en cuero negro.

Estructura y respaldo en fresno lacado a poro abierto en rojo coral (RAL 3016). Asiento tapizado en cuero tostado.

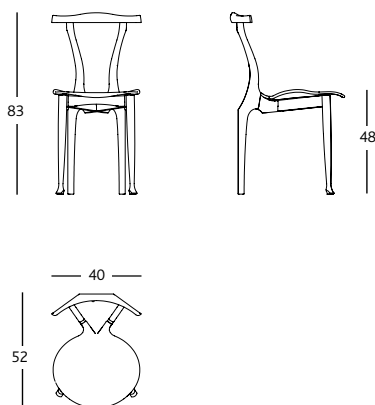

GAUTFR13C13	Natural	
GAUTFR10C10	Black / Negro	993
GAUTFR20C20	Coral red / Rojo coral	

Soft felt glides included. See page 18 / Tacos de fieltro incluidos. Ver pág. 18

#### PACKAGING

PCS	DIMENSIONS CM	GROSS KG
1	60 x 60 x 85	5

### GAULINO CHAIR / SILLA

Oscar Tusquets

3 different finishes:

Structure and backrest in natural varnished ash. Seat upholstered in natural hide.

Structure and backrest in open pore lacquered ash in black. Seat upholstered in black hide.

Structure and backrest in open pore open lacquered ash in coral red (RAL 3016). Seat upholstered in toasted hide.

3 acabados diferentes:

Estructura y respaldo en fresno macizo natural barnizado. Asiento tapizado en cuero natural.

Estructura y respaldo en fresno lacado a poro abierto en negro. Asiento tapizado en cuero negro.

Estructura y respaldo en fresno lacado a poro abierto en rojo coral (RAL 3016). Asiento tapizado en cuero tostado.

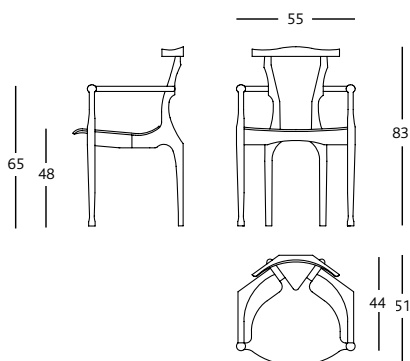

GAUFR13C13	Natural	
GAUFR10C10	Black / Negro	1.213
GAUFR20C20	Coral red / Rojo coral	

Soft felt glides included. See page 18 / Tacos de fieltro incluidos. Ver pág. 18

See matching table on pag. 40 / Ver mesa a juego en pág. 40

#### PACKAGING

PCS	DIMENSIONS CM	GROSS KG
1	60 x 60 x 90	8

## CHAIR B

Konstantin Grcic

The lateral sides and upper side of the seat are made of veneered beech plywood. The underside is veneered in ash wood. The backrest is made of solid ash wood. Finishes: varnished in natural ash or lacquered black. Bottom structure in tubular steel and pieces in cast aluminium with a powder coating in white or black. An upholstered leather or fabric seat version is also available.

Laterales en madera contrachapada de haya. Asiento en madera contrachapada de haya con cara superior en fresno y inferior en haya. Respaldo en madera maciza de fresno. Madera barnizada o teñido negro. Estructura inferior en tubo de acero y piezas de fundición en aluminio. Pintada en polvo en blanco o negro. Disponible versión con asiento tapizado en piel y tejido.

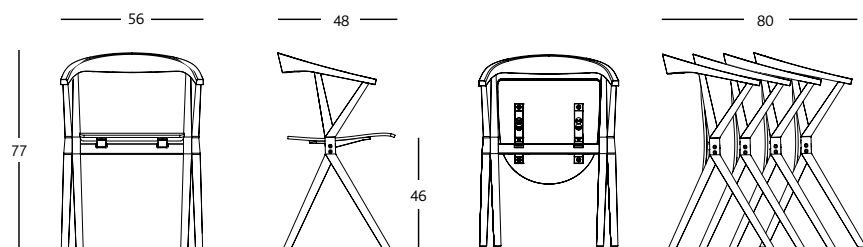

	CAT 1	CAT 2	CAT 3	CAT 4	P	S	V/F
<b>Natural ash</b> <i>Fresno natural</i>	694	833	843	852	868	888	941
<b>Black lacquered ash</b> <i>Fresno lacado negro</i>	715	843	853	868	878	897	950

Soft felt glides included. See page 18 / *Tacos de fieltro incluidos. Ver pág 18*  
See matching table on page 41 / *Ver mesa a juego en pág. 41*



Delta Silver Award 2011 / Premio Delta Plata 2011

### PACKAGING

	PCS	DIMENSIONS CM	GROSS KG
Not upholstered seat / <i>Asiento no tapizado</i>	1	60 x 45 x 82	8
Upholstered seat / <i>Asiento tapizado</i>	1	60 x 45 x 82	10

## MINIVARIUS CHAIR / SILLA

Oscar Tusquets

Structure in tubular steel painted in anodic black. A one-piece seat in gas injected polypropylene in black or white. Also available in an upholstered version in BD materials.

Estructura en tubo de acero pintado en anodic black. Asiento monocarcasa, en polipropileno inyectado con gas en blanco o negro. Asiento tapizado en los diferentes tejidos de BD.

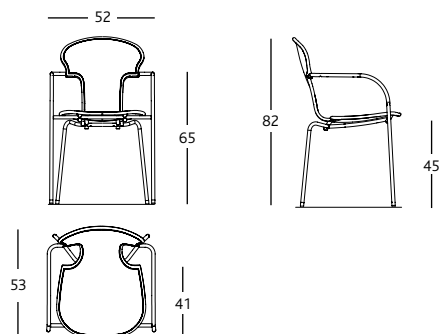

	PL	*COM	CAT1	CAT2	CAT3	CAT4
<b>Minivarius</b>	212	441	539	563	604	636

- For fabric widths of 1'6m, 1'3m is needed.
- For fabric widths of 1'4m, 1'5m is needed.
- See finishes pages 7-14

- Para anchos de tela de 1'6m, se necesitan 1'3m.
- Para anchos de tela de 1'4m, se necesitan 1'5m.
- Ver acabados páginas 7-17

\*COM : Customer's own material / *Tejido o piel del cliente*

\*\*Consult conditions / *Consultar condiciones*

### PACKAGING

PCS	MEDIDAS CM	GROSS KG
1	65 x 58 x 110	11



## SHOWTIME &amp; SHOWTIME NUDE CHAIR / SILLA

Jaime Hayon

Two backrests: low backrest (Showtime), medium backrest (Showtime Nude). 5 distinct leg structures. Available in a wide variety of finishes - wooden or lacquered (in diverse colours) and upholstered in different materials and leathers by BD, which avails all possible combinations and contrasts.

Dos alturas diferentes para el respaldo: respaldo bajo (Showtime), respaldo medio (Showtime Nude). 5 estructuras distintas para las patas. Disponible en un amplio programa de acabados - madera o lacados en diversos colores y tapizados en diferentes tejidos y pieles de BD - que admiten todas las combinaciones y contrastes posibles.

## SHOWTIME (low backrest / respaldo bajo)

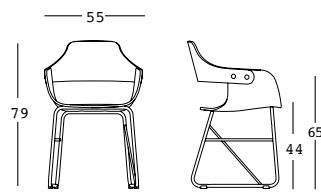
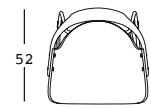
SHOWTIME  
SLED BASE / BASE PATÍN

Lacquered or Natural ash  
*Laca o fresno natural*

Walnut / Ash stained (oak or black)  
*Nogal / Fresno teñido (roble o negro)*

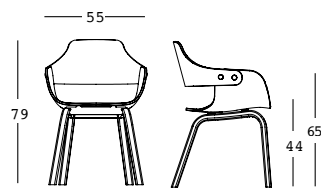
SHOWTIME  
WOODEN LEGS / PATAS MADERA

Lacquered or Natural ash  
*Laca o fresno natural*

Walnut / Ash stained (oak or black)  
*Nogal / Fresno teñido (roble o negro)*

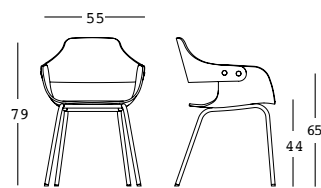
SHOWTIME  
METAL LEGS / PATAS METAL

Lacquered or Natural ash  
*Laca o fresno natural*

Walnut / Ash stained (oak or black)  
*Nogal / Fresno teñido (roble o negro)*

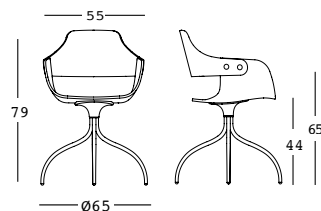
SHOWTIME  
SWIVEL BASE / PIE GIRATORIO

Lacquered or Natural ash  
*Laca o fresno natural*

Walnut / Ash stained (oak or black)  
*Nogal / Fresno teñido (roble o negro)*

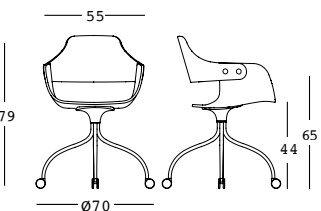
SHOWTIME  
WHEELS / RUEDAS

Lacquered or Natural ash  
*Laca o fresno natural*

Walnut / Ash stained (oak or black)  
*Nogal / Fresno teñido (roble o negro)*

## SHOWTIME NUDE (medium backrest / respaldo medio)

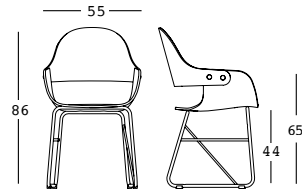
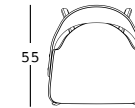
SHOWTIME NUDE  
SLED BASE / BASE PATÍN

Natural ash  
*Fresno natural*

Walnut / Ash stained black  
*Nogal / Fresno teñido negro*

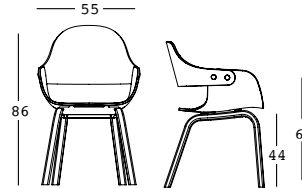
SHOWTIME NUDE  
WOODEN LEGS / PATAS MADERA

Natural ash  
*Fresno natural*

Walnut / Ash stained black  
*Nogal / Fresno teñido negro*

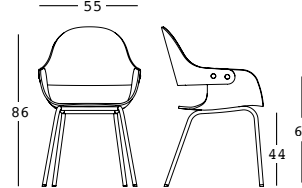
SHOWTIME NUDE  
METAL LEGS / PATAS METAL

Natural ash  
*Fresno natural*

Walnut / Ash stained black  
*Nogal / Fresno teñido negro*

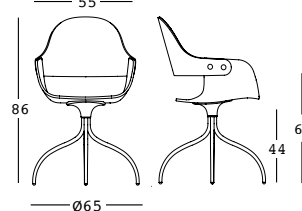
SHOWTIME NUDE  
SWIVEL BASE / PIE GIRATORIO

Natural ash  
*Fresno natural*

Walnut / Ash stained black  
*Nogal / Fresno teñido negro*

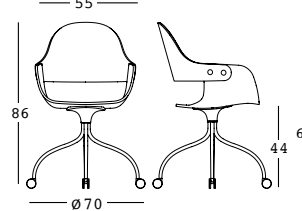



SHOWTIME NUDE  
WHEELS / RUEDAS

Natural ash  
*Fresno natural*

Walnut / Ash stained black  
*Nogal / Fresno teñido negro*

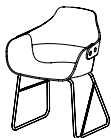



Upholstered seat height will be 45cm and arm height in case of additional armrests will be 67cm  
*La altura del asiento tapizado será de 45 cm y la altura del brazo en caso de reposabrazos adicionales será de 67 cm.*

## SHOWTIME SLED / PATÍN

	WOOD	COM	CAT 1	CAT 2	CAT3/Y	CAT 4	P	S	V / F
	Lacquered or Natural ash / <i>Laca o fresno natural</i>	650							
	Walnut / Ash stained (oak or black) <i>Nogal / Fresno teñido (roble o negro)</i>	675							
	Lacquered or Natural ash / <i>Laca o fresno natural</i>	825	853	864	869	880	897	919	930
	Walnut / Ash stained (oak or black) <i>Nogal / Fresno teñido (roble o negro)</i>	853	880	891	897	908	924	946	957
	Lacquered or Natural ash / <i>Laca o fresno natural</i> (Armrests included / <i>Reposabrazos incluidos</i> )	1.017	1.119	1.149	1.175	1.220	1.281	1.352	1.388
	Walnut / Ash stained (oak or black) <i>Nogal / Fresno teñido (roble o negro)</i> (Armrests included / <i>Reposabrazos incluidos</i> )	1.042	1.144	1.174	1.200	1.245	1.306	1.377	1.413
	Lacquered or Natural ash / <i>Laca o fresno natural</i>	867	954	984	1.010	1.056	1.107	1.178	1.214
	Walnut / Ash stained (oak or black) <i>Nogal / Fresno teñido (roble o negro)</i>	893	979	1.010	1.035	1.081	1.132	1.204	1.239
	Lacquered or Natural ash / <i>Laca o fresno natural</i> (Armrests included / <i>Reposabrazos incluidos</i> )	1.117	1.279	1.329	1.375	1.455	1.551	1.672	1.733
	Walnut / Ash stained (oak or black) <i>Nogal / Fresno teñido (roble o negro)</i> (Armrests included / <i>Reposabrazos incluidos</i> )	1.142	1.304	1.354	1.400	1.480	1.576	1.697	1.758

See optional accessories on pag. 80 / Ver accesorios opcionales en pág. 80











## SHOWTIME 4 WOODEN LEGS / 4 PATAS MADERA

	WOOD	COM	CAT 1	CAT 2	CAT3/Y	CAT 4	P	S	V / F
	Lacquered or Natural ash / <i>Laca o fresno natural</i>	750							
	Walnut / Ash stained (oak or black) <i>Nogal / Fresno teñido (roble o negro)</i>	775							
	Lacquered or Natural ash / <i>Laca o fresno natural</i>	935	963	974	979	990	1.007	1.029	1.040
	Walnut / Ash stained (oak or black) <i>Nogal / Fresno teñido (roble o negro)</i>	963	990	1.001	1.007	1.018	1.034	1.056	1.067
	Lacquered or Natural ash / <i>Laca o fresno natural</i> (Armrests included / <i>Reposabrazos incluidos</i> )	1.117	1.279	1.249	1.275	1.320	1.381	1.452	1.488
	Walnut / Ash stained (oak or black) <i>Nogal / Fresno teñido (roble o negro)</i> (Armrests included / <i>Reposabrazos incluidos</i> )	1.142	1.244	1.274	1.300	1.345	1.406	1.477	1.513
	Lacquered or Natural ash / <i>Laca o fresno natural</i>	969	1.056	1.086	1.112	1.158	1.209	1.280	1.316
	Walnut / Ash stained (oak or black) <i>Nogal / Fresno teñido (roble o negro)</i>	995	1.081	1.112	1.137	1.183	1.234	1.306	1.341
	Lacquered or Natural ash / <i>Laca o fresno natural</i> (Armrests included / <i>Reposabrazos incluidos</i> )	1.217	1.379	1.429	1.475	1.555	1.651	1.772	1.833
	Walnut / Ash stained (oak or black) <i>Nogal / Fresno teñido (roble o negro)</i> (Armrests included / <i>Reposabrazos incluidos</i> )	1.242	1.404	1.454	1.500	1.580	1.676	1.797	1.858

See optional accessories on pag. 80 / Ver accesorios opcionales en pág. 80









## SHOWTIME SWIVEL BASE / BASE GIRATORIA

	WOOD	COM	CAT 1	CAT 2	CAT3/Y	CAT 4	P	S	V / F
 Lacquered or Natural ash / <i>Laca o fresno natural</i>	850								
 Walnut / Ash stained (oak or black) <i>Nogal / Fresno teñido (roble o negro)</i>	875								
 Lacquered or Natural ash / <i>Laca o fresno natural</i>		1.045	1.073	1.084	1.089	1.100	1.117	1.139	1.150
 Walnut / Ash stained (oak or black) <i>Nogal / Fresno teñido (roble o negro)</i>		1.073	1.100	1.111	1.117	1.128	1.144	1.166	1.177
 Lacquered or Natural ash / <i>Laca o fresno natural</i> (Armrests included / <i>Reposabrazos incluidos</i> )		1.217	1.319	1.349	1.375	1.420	1.481	1.552	1.588
 Walnut / Ash stained (oak or black) <i>Nogal / Fresno teñido (roble o negro)</i> (Armrests included / <i>Reposabrazos incluidos</i> )		1.242	1.344	1.374	1.400	1.445	1.506	1.577	1.613
 Lacquered or Natural ash / <i>Laca o fresno natural</i>		1.071	1.158	1.188	1.214	1.260	1.311	1.382	1.418
 Walnut / Ash stained (oak or black) <i>Nogal / Fresno teñido (roble o negro)</i>		1.097	1.183	1.214	1.239	1.285	1.336	1.408	1.443
 Lacquered or Natural ash / <i>Laca o fresno natural</i> (Armrests included / <i>Reposabrazos incluidos</i> )		1.317	1.479	1.529	1.575	1.655	1.751	1.872	1.933
 Walnut / Ash stained (oak or black) <i>Nogal / Fresno teñido (roble o negro)</i> (Armrests included / <i>Reposabrazos incluidos</i> )		1.342	1.504	1.554	1.600	1.680	1.776	1.897	1.958





See optional accessories on pag. 80 / Ver accesorios opcionales en pág. 80

## SHOWTIME 4 METAL LEGS / 4 PATAS METAL

	WOOD	COM	CAT 1	CAT 2	CAT3/Y	CAT 4	P	S	V / F
 Lacquered or Natural ash / <i>Laca o fresno natural</i>	600								
 Walnut / Ash stained (oak or black) <i>Nogal / Fresno teñido (roble o negro)</i>	625								
 Lacquered or Natural ash / <i>Laca o fresno natural</i>		743	770	781	787	798	814	836	847
 Walnut / Ash stained (oak or black) <i>Nogal / Fresno teñido (roble o negro)</i>		798	825	836	842	853	869	891	902
 Lacquered or Natural ash / <i>Laca o fresno natural</i> (Armrests included / <i>Reposabrazos incluidos</i> )		967	1.069	1.099	1.125	1.170	1.231	1.302	1.338
 Walnut / Ash stained (oak or black) <i>Nogal / Fresno teñido (roble o negro)</i> (Armrests included / <i>Reposabrazos incluidos</i> )		992	1.094	1.124	1.150	1.195	1.256	1.327	1.363
 Lacquered or Natural ash / <i>Laca o fresno natural</i>		816	903	933	959	1.005	1.056	1.127	1.163
Walnut / Ash stained (oak or black) <i>Nogal / Fresno teñido (roble o negro)</i>		842	928	959	984	1.030	1.081	1.153	1.188
Lacquered or Natural ash / <i>Laca o fresno natural</i> (Armrests included / <i>Reposabrazos incluidos</i> )		1.067	1.229	1.279	1.325	1.405	1.501	1.622	1.683
Walnut / Ash stained (oak or black) <i>Nogal / Fresno teñido (roble o negro)</i> (Armrests included / <i>Reposabrazos incluidos</i> )		1.092	1.254	1.304	1.350	1.430	1.526	1.647	1.708





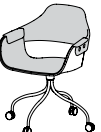





See optional accessories on pag. 80 / Ver accesorios opcionales en pág. 80

## SHOWTIME WHEELS / RUEDAS

	WOOD	COM	CAT 1	CAT 2	CAT3/Y	CAT 4	P	S	V / F
	Lacquered or Natural ash / <i>Laca o fresno natural</i>	950							
	Walnut / Ash stained (oak or black) <i>Nogal / Fresno teñido (roble o negro)</i>	975							
	Lacquered or Natural ash / <i>Laca o fresno natural</i>		1.155	1.183	1.194	1.199	1.210	1.227	1.249 1.260
	Walnut / Ash stained (oak or black) <i>Nogal / Fresno teñido (roble o negro)</i>		1.183	1.210	1.221	1.227	1.238	1.254	1.276 1.287
	Lacquered or Natural ash / <i>Laca o fresno natural</i> (Armrests included / <i>Reposabrazos incluidos</i> )		1.317	1.419	1.449	1.475	1.520	1.581	1.652 1.688
	Walnut / Ash stained (oak or black) <i>Nogal / Fresno teñido (roble o negro)</i> (Armrests included / <i>Reposabrazos incluidos</i> )		1.342	1.444	1.474	1.500	1.545	1.606	1.677 1.713
	Lacquered or Natural ash / <i>Laca o fresno natural</i>		1.173	1.260	1.290	1.316	1.362	1.413	1.484 1.520
	Walnut / Ash stained (oak or black) <i>Nogal / Fresno teñido (roble o negro)</i>		1.199	1.285	1.316	1.341	1.387	1.438	1.510 1.545
	Lacquered or Natural ash / <i>Laca o fresno natural</i> (Armrests included / <i>Reposabrazos incluidos</i> )		1.417	1.579	1.629	1.675	1.755	1.851	1.972 2.033
	Walnut / Ash stained (oak or black) <i>Nogal / Fresno teñido (roble o negro)</i> (Armrests included / <i>Reposabrazos incluidos</i> )		1.442	1.604	1.654	1.700	1.780	1.876	1.997 2.058

See optional accessories on pag. 80 / Ver accesorios opcionales en pág. 80

SHOWTIME NUDE SLED / PATÍN

	WOOD	COM	CAT 1	CAT 2	CAT 3/Y	CAT 4	P	S	V / F
 Natural ash / <i>Fresno natural</i>	675								
 Walnut / Ash stained black <i>Nogal / Fresno teñido negro</i>	700								
 Natural ash / <i>Fresno natural</i>		853	880	891	897	908	924	946	957
 Walnut / Ash stained black <i>Nogal / Fresno teñido negro</i>		880	908	919	924	935	952	974	985
 Natural ash / <i>Fresno natural</i> (Armrests included / <i>Reposabrazos incluidos</i> )		1.042	1.144	1.174	1.200	1.245	1.306	1.377	1.413
 Walnut / Ash stained black <i>Nogal / Fresno teñido negro</i> (Armrests included / <i>Reposabrazos incluidos</i> )		1.067	1.169	1.199	1.225	1.270	1.331	1.402	1.438
 Natural ash / <i>Fresno natural</i>		918	995	1.025	1.051	1.097	1.158	1.229	1.270
 Walnut / Ash stained black <i>Nogal / Fresno teñido negro</i>		944	1.020	1.051	1.076	1.122	1.183	1.255	1.295
 Natural ash / <i>Fresno natural</i> (Armrests included / <i>Reposabrazos incluidos</i> )		1.127	1.319	1.369	1.415	1.495	1.601	1.722	1.788
 Walnut / Ash stained black <i>Nogal / Fresno teñido negro</i> (Armrests included / <i>Reposabrazos incluidos</i> )		1.152	1.344	1.394	1.440	1.520	1.626	1.747	1.813
Natural ash / <i>Fresno natural</i>		935	1.020	1.040	1.050	1.070	1.100	1.140	1.160
Walnut / Ash stained black <i>Nogal / Fresno teñido negro</i>		960	1.045	1.065	1.075	1.095	1.125	1.165	1.185
Natural ash / <i>Fresno natural</i> (Armrests included / <i>Reposabrazos incluidos</i> )		1.202	1.349	1.399	1.435	1.515	1.601	1.732	1.798
Walnut / Ash stained black <i>Nogal / Fresno teñido negro</i> (Armrests included / <i>Reposabrazos incluidos</i> )		1.227	1.374	1.424	1.460	1.540	1.626	1.757	1.823

See optional accessories on pag. 80 / Ver accesorios opcionales en pág. 80

STORAGE AND SHELVING  
ESTANTERÍAS Y CONTENEDORES

TABLES  
MESAS

ARMCHAIRS  
BUTACAS

CHAIRS AND STOOLS  
SILLAS Y TABURETES







ACCESSORIES  
ACCESORIOS

LIGHTING  
ILUMINACIÓN

PUBLIC SEATING  
ASIENTOS PÚBLICOS

ART EDITIONS

## SHOWTIME NUDE 4 WOODEN LEGS / 4 PATAS MADERA

	WOOD	COM	CAT 1	CAT 2	CAT 3/Y	CAT 4	P	S	V / F
	Natural ash / <i>Fresno natural</i>	775							
	Walnut / Ash stained black <i>Nogal / Fresno teñido negro</i>	800							
	Natural ash / <i>Fresno natural</i>	963	990	1.001	1.007	1.018	1.034	1.056	1.067
	Walnut / Ash stained black <i>Nogal / Fresno teñido negro</i>	990	1.018	1.029	1.034	1.045	1.062	1.084	1.095
	Natural ash / <i>Fresno natural</i> (Armrests included / <i>Reposabrazos incluidos</i> )	1.142	1.244	1.274	1.300	1.345	1.406	1.477	1.513
	Walnut / Ash stained black <i>Nogal / Fresno teñido negro</i> (Armrests included / <i>Reposabrazos incluidos</i> )	1.167	1.269	1.299	1.325	1.370	1.431	1.502	1.538
	Natural ash / <i>Fresno natural</i>	1.020	1.097	1.127	1.153	1.199	1.260	1.331	1.372
	Walnut / Ash stained black <i>Nogal / Fresno teñido negro</i>	1.046	1.122	1.153	1.178	1.224	1.285	1.357	1.397
	Natural ash / <i>Fresno natural</i> (Armrests included / <i>Reposabrazos incluidos</i> )	1.227	1.419	1.469	1.515	1.595	1.701	1.822	1.888
	Walnut / Ash stained black <i>Nogal / Fresno teñido negro</i> (Armrests included / <i>Reposabrazos incluidos</i> )	1.252	1.444	1.494	1.540	1.620	1.726	1.847	1.913
	Natural ash / <i>Fresno natural</i>	1.035	1.120	1.140	1.150	1.170	1.200	1.240	1.260
	Walnut / Ash stained black <i>Nogal / Fresno teñido negro</i>	1.060	1.145	1.165	1.175	1.195	1.225	1.265	1.285
	Natural ash / <i>Fresno natural</i> (Armrests included / <i>Reposabrazos incluidos</i> )	1.302	1.449	1.499	1.535	1.615	1.701	1.832	1.898
	Walnut / Ash stained black <i>Nogal / Fresno teñido negro</i> (Armrests included / <i>Reposabrazos incluidos</i> )	1.327	1.474	1.524	1.560	1.640	1.726	1.857	1.923

See optional accessories on pag. 80 / Ver accesorios opcionales en pág. 80

# SHOWTIME NUDE SWIVEL BASE / BASE GIRATORIA

STORAGE AND SHELVING  
ESTANTERÍAS Y CONTENEDORES

TABLES  
MESAS

ARMCHAIRS  
BUTACAS







CHAIRS AND STOOLS  
SILLAS Y TABURETES

ACCESSORIES  
ACCESORIOS

LIGHTING  
ILUMINACIÓN





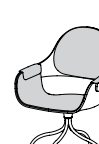

PUBLIC SEATING  
ASIENTOS PÚBLICOS

ART EDITIONS

		WOOD	COM	CAT 1	CAT 2	CAT 3/Y	CAT 4	P	S	V / F
	Natural ash / <i>Fresno natural</i>	875								
	Walnut / Ash stained black <i>Nogal / Fresno teñido negro</i>	900								
	Natural ash / <i>Fresno natural</i>		1.073	1.100	1.111	1.117	1.128	1.144	1.166	1.177
	Walnut / Ash stained black <i>Nogal / Fresno teñido negro</i>		1.100	1.128	1.139	1.144	1.155	1.172	1.194	1.205
	Natural ash / <i>Fresno natural</i> (Armrests included / <i>Reposabrazos incluidos</i> )		1.242	1.344	1.374	1.400	1.445	1.506	1.577	1.613
	Walnut / Ash stained black <i>Nogal / Fresno teñido negro</i> (Armrests included / <i>Reposabrazos incluidos</i> )		1.267	1.369	1.399	1.425	1.470	1.531	1.602	1.638
	Natural ash / <i>Fresno natural</i>		1.122	1.199	1.229	1.255	1.301	1.362	1.433	1.474
	Walnut / Ash stained black <i>Nogal / Fresno teñido negro</i>		1.148	1.224	1.255	1.280	1.326	1.387	1.459	1.499
	Natural ash / <i>Fresno natural</i> (Armrests included / <i>Reposabrazos incluidos</i> )		1.327	1.519	1.569	1.615	1.695	1.801	1.922	1.988
	Walnut / Ash stained black <i>Nogal / Fresno teñido negro</i> (Armrests included / <i>Reposabrazos incluidos</i> )		1.352	1.544	1.594	1.640	1.720	1.826	1.947	2.013
	Natural ash / <i>Fresno natural</i>		1.135	1.220	1.240	1.250	1.270	1.300	1.340	1.360
	Walnut / Ash stained black <i>Nogal / Fresno teñido negro</i>		1.160	1.245	1.265	1.275	1.295	1.325	1.365	1.385
	Natural ash / <i>Fresno natural</i> (Armrests included / <i>Reposabrazos incluidos</i> )		1.402	1.549	1.599	1.635	1.715	1.801	1.932	1.998
	Walnut / Ash stained black <i>Nogal / Fresno teñido negro</i> (Armrests included / <i>Reposabrazos incluidos</i> )		1.427	1.574	1.624	1.660	1.740	1.826	1.957	2.023







See optional accessories on pag. 80 / Ver accesorios opcionales en pag. 80

## SHOWTIME NUDE 4 METAL LEGS / 4 PATAS METAL

	WOOD	COM	CAT 1	CAT 2	CAT 3/Y	CAT 4	P	S	V / F
	Natural ash / <i>Fresno natural</i>	625							
	Walnut / Ash stained black <i>Nogal / Fresno teñido negro</i>	650							
	Natural ash / <i>Fresno natural</i>		798	825	836	842	853	869	891 902
	Walnut / Ash stained black <i>Nogal / Fresno teñido negro</i>		825	853	864	869	880	897	919 930
	Natural ash / <i>Fresno natural</i> (Armrests included / <i>Reposabrazos incluidos</i> )		992	1.024	1.124	1.150	1.195	1.256	1.327 1.363
	Walnut / Ash stained black <i>Nogal / Fresno teñido negro</i> (Armrests included / <i>Reposabrazos incluidos</i> )		1.017	1.119	1.149	1.175	1.220	1.281	1.352 1.388
	Natural ash / <i>Fresno natural</i>		867	944	974	1.000	1.046	1.107	1.178 1.219
	Walnut / Ash stained black <i>Nogal / Fresno teñido negro</i>		893	969	1.000	1.025	1.071	1.132	1.204 1.244
	Natural ash / <i>Fresno natural</i> (Armrests included / <i>Reposabrazos incluidos</i> )		1.077	1.269	1.319	1.365	1.445	1.551	1.672 1.738
	Walnut / Ash stained black <i>Nogal / Fresno teñido negro</i> (Armrests included / <i>Reposabrazos incluidos</i> )		1.102	1.294	1.344	1.390	1.470	1.576	1.697 1.763
	Natural ash / <i>Fresno natural</i>		885	970	990	1.000	1.020	1.050	1.090 1.110
	Walnut / Ash stained black <i>Nogal / Fresno teñido negro</i>		910	995	1.015	1.025	1.045	1.075	1.115 1.135
	Natural ash / <i>Fresno natural</i> (Armrests included / <i>Reposabrazos incluidos</i> )		1.152	1.299	1.349	1.385	1.465	1.551	1.682 1.748
	Walnut / Ash stained black <i>Nogal / Fresno teñido negro</i> (Armrests included / <i>Reposabrazos incluidos</i> )		1.177	1.324	1.374	1.410	1.490	1.576	1.707 1.773









See optional accessories on pag. 80 / *Ver accesorios opcionales en pág. 80*

## SHOWTIME NUDE WHEELS / RUEDAS

	WOOD	COM	CAT 1	CAT 2	CAT 3/Y	CAT 4	P	S	V / F
	Natural ash / <i>Fresno natural</i>	975							
	Walnut / Ash stained black <i>Nogal / Fresno teñido negro</i>	1.000							
	Natural ash / <i>Fresno natural</i>		1.183	1.210	1.221	1.227	1.238	1.254	1.276 1.287
	Walnut / Ash stained black <i>Nogal / Fresno teñido negro</i>		1.210	1.238	1.249	1.254	1.265	1.282	1.304 1.315
	Natural ash / <i>Fresno natural</i> (Armrests included / <i>Reposabrazos incluidos</i> )		1.342	1.444	1.474	1.500	1.545	1.606	1.677 1.713
	Walnut / Ash stained black <i>Nogal / Fresno teñido negro</i> (Armrests included / <i>Reposabrazos incluidos</i> )		1.367	1.469	1.499	1.525	1.570	1.631	1.702 1.738
	Natural ash / <i>Fresno natural</i>		1.224	1.301	1.331	1.357	1.403	1.464	1.535 1.576
	Walnut / Ash stained black <i>Nogal / Fresno teñido negro</i>		1.250	1.326	1.357	1.382	1.428	1.489	1.561 1.601
	Natural ash / <i>Fresno natural</i> (Armrests included / <i>Reposabrazos incluidos</i> )		1.427	1.619	1.669	1.715	1.795	1.901	2.022 2.088
	Walnut / Ash stained black <i>Nogal / Fresno teñido negro</i> (Armrests included / <i>Reposabrazos incluidos</i> )		1.452	1.644	1.694	1.740	1.820	1.926	2.047 2.113
	Natural ash / <i>Fresno natural</i>		1.235	1.320	1.340	1.350	1.370	1.400	1.440 1.460
	Walnut / Ash stained black <i>Nogal / Fresno teñido negro</i>		1.260	1.345	1.365	1.375	1.395	1.425	1.465 1.485
	Natural ash / <i>Fresno natural</i> (Armrests included / <i>Reposabrazos incluidos</i> )		1.502	1.649	1.699	1.735	1.815	1.901	2.032 2.098
	Walnut / Ash stained black <i>Nogal / Fresno teñido negro</i> (Armrests included / <i>Reposabrazos incluidos</i> )		1.527	1.674	1.724	1.760	1.840	1.926	2.057 2.123

See optional accessories on pag. 80 / *Ver accesorios opcionales en pág. 80*

## SHOWTIME & SHOWTIME NUDE OPTIONAL ACCESSORIES / ACCESORIOS OPCIONALES

	COM	CAT1	CAT2	CAT 3 / Y	CAT 4	P	S	V/F
 Armrests / Brazos	127	154	164	170	180	196	217	223
 Removable cushion / Cojín extraíble Showtime & Nude	130	156	166	172	182	198	218	224
 Upholstered Seat / Asiento Tapizado Showtime & Nude	110	138	149	154	165	182	204	215
 Upholstered interior seat/ Contra-Asiento Tapizado Showtime & Nude	245	321	342	362	398	444	495	525
 Upholstered Backrest / Respaldo Tapizado Showtime	102	163	184	204	240	275	326	352
 *Upholstered Backrest / Respaldo Tapizado Showtime Nude	128	179	199	219	255	301	352	383
 Upholstered Interior Backrest / Respaldo Interior Tapizado Showtime Nude	163	224	235	240	250	265	286	296
 Cushion diamond stitching / Cojín cosido rombos	55							
Interior seat diamond stitching / Cosido rombos contra-asiento	66							
Extra cost for non standard thread (per order) / Coste extra hilo no estándar	115							
Soft felt glides swivel structure / Tacos con fieltro base giratoria	38							
Soft felt glides Sled base / Tacos con fieltro base patín	19							

\*For glides see page 18. / Para tacos ver página 18.

### Metres of material required

Seat cushion - Fabric 60 x 140 cm - Leather 0,55 m<sup>2</sup>  
 Removable cushion - Fabric 60 x 140 cm - Leather 0,55 m<sup>2</sup>  
 Interior seat - Fabric 70 x 140 cm - Leather 0,65 m<sup>2</sup>  
 Backrest Showtime - Fabric 80 x 140 cm - Leather 1,10 m<sup>2</sup>  
 Backrest Nude - Fabric 90 x 140 cm - Leather 1,20 m<sup>2</sup>  
 Interior backrest - Fabric 70 x 140 cm - leather 0,9 m<sup>2</sup>  
 Armrests - Fabric 18 x 140 cm - Leather 0,2 m<sup>2</sup>

### Metros de material requerido

Cojín - Tela 60 x 140 cm - Piel 0,55 m<sup>2</sup>  
 Cojín extraíble - Tela 60 x 140 cm - Piel 0,55 m<sup>2</sup>  
 Contra-Asiento - Tela 70 x 140 cm - Piel 0,65 m<sup>2</sup>  
 Respaldo Showtime - Tela 80 x 140 cm - Piel 1,10 m<sup>2</sup>  
 Respaldo Nude - Tela 90 x 140 cm - Piel 1,20 m<sup>2</sup>  
 Respaldo interior - Tela 70 x 140 cm - Piel 0,9 m<sup>2</sup>  
 Brazos - Tela 18 x 140 cm - Piel 0,2 m<sup>2</sup>

Customize your own version with our online configurator  
 Personaliza tu propia versión con nuestro configurador online  
[www.bdbarcelona.com](http://www.bdbarcelona.com)

### PACKAGING

	PCS	MEDIDAS CM	BRUTO KG
Showtime	1	65 x 58 x 86	11
Showtime Nude	1	60 x 65 x 95	12





**COLOUR OF STRUCTURE / COLOR DE ESTRUCTURA**

Anthracite grey / *Gris antracita* (RAL 7021 matte)  
Pale brown / *Marrón claro* (RAL 8025 matte)  
Beige (RAL 1001 matte)

**FABRICS AND LEATHER / TELAS Y PIELES**

CAT 1 Libra  
CAT 2 Iris & Gaudí  
CAT 3 Fusion  
CAT 4 Moss  
Y - Medley  
P - Panama  
S - Sauvage  
V - Vintage  
F - Florida

**SEAT AND BACK FINISHES / ACABADOS RESPALDO Y ASIENTO**

**SHOWTIME CHAIR**

**MATTE LACQUER / LACA MATE:**

White / *Blanco* LACM04 (RAL 9003)  
Black / *Negro* LACM10 (RAL 9005)  
Red / *Rojo* LACM19 (RAL 3004)  
Blue / *Azul* LACM17 (RAL 5003)

**WOOD / MADERA:**

Walnut Nature Effect / *Nogal Efecto Nature*  
Natural ash / *Fresno natural*  
Ash stained oak / *Fresno teñido roble*  
Ash stained black / *Fresno teñido negro*

**SHOWTIME NUDE CHAIR**

**WOOD / MADERA:**

Walnut Nature Effect / *Nogal Efecto Nature*  
Natural ash / *Fresno natural*  
Ash stained black / *Fresno teñido negro*

## SHOWTIME & NUDE DIAMOND STITCHING FINISHES / ACABADO COSIDO ROMBOS - FABRICS / TELAS

### CAT 1 - LIBRA



TL53 Dark Brown  
+ Yellow 106



TL49 Grey  
+ Dark Blue 13



TL62 Pink  
+ Light Grey 70+2613

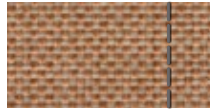

TL29 Pale Pink  
+ Light Grey 70+2613



TL20 Beige  
+ Brown 696



TL37 Green  
+ Brown 696



TL10 Brown  
+ Brown 696

### CAT 2 - IRIS

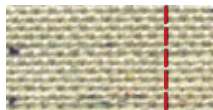

TI5 Beige  
+ Red 156

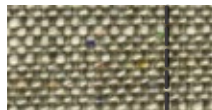

TI11 Grey  
+ Dark Grey 36



TI20 Brown  
+ Red 156

### CAT 2 - GAUDÍ



TG02 Light Grey  
+ Dark Grey 36

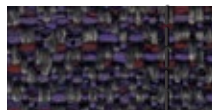

TG48 Purple  
+ Dark Grey 36



TG60 Orange  
+ Dark Grey 36



TG53 Dark Grey  
+ Dark Grey 36



TG29 Pale Pink  
+ Dark Grey 36



TG12 Grey  
+ Dark Grey 36

### CAT 3 - FUSION



TF05 Beige  
+ Red 156



TF125 Mustard  
+ Brown 696



TF138 Green  
+ Mustard 968



TF143 Blue  
+ Light Blue 112



TF54 Light Grey  
+ Dark Grey 36



TF53 Dark Grey  
+ Cian 761



TF122 Granet  
+ Dark Grey 36



TF155 Anthracite  
+ Cian 761

### CAT 4 - MOSS



TM24 Orange Brown  
+ Dark Grey 36



TM45 Blue  
+ Light Blue 112



TM53 Grey  
+ Cian 761



TM65 Red  
+ Dark grey 36

SHOWTIME & NUDE DIAMOND STITCHING FINISHES / ACABADO COSIDO ROMBOS - LEATHERS / PIELES

V - VINTAGE



V18 Camel  
+ Brown 696



V24 Creta  
+ Light Grey 70+2613



V23 Sepia  
+ Dark Grey 36



V22 Grey  
+ Brown 696



V19 T.Moro  
+ Mustard 968



V10 Black  
+ Dark Grey 36

S - SAUVAGE



S45 Clay  
+ Brown 696



S40 Black  
+ Dark Grey 36



S46 Alpine  
+ Dark Grey 36



S50 Grapefruit  
+ Dark Grey 36

CAT F - FLORIDA



F25 Yellow  
+ Brown 696



F15 Camel  
+ Brown 696



F20 D.Orange  
+ Dark Grey 36

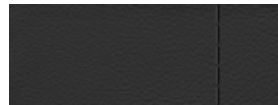

F27 A.Grey  
+ Dark Grey 36



F10 Black  
+ Cian 761

P - PANAMA



P04 White  
+ Light Grey



P01 Sand  
+ Burgundy 226



P15 Brown  
+ Brown 696

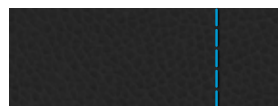

P10 Black  
+ Cian 761

STORAGE AND SHELVING  
ESTANTERÍAS Y CONTENEDORES

TABLES  
MESAS

ARMCHAIRS  
BUTACAS

CHAIRS AND STOOLS  
SILLAS Y TABURETES

ACCESSORIES  
ACCESORIOS

LIGHTING  
ILUMINACIÓN

PUBLIC SEATING  
ASIENTOS PÚBLICOS

ART EDITIONS

# JAMAICA STOOL / TABURETE



Pepe Cortés

A steel chromed five legged stool. Swivel seat in a bright polished cast aluminium AG3 and anodised silver, or integrated with a solid varnished beech wooden seat. Available with wheels in a lower version.

All Black version (66cm and 77cm): anodic black steel structure and seat in stained beech wood or painted Anodic Black aluminium.

Taburete con estructura de 5 patas realizada en acero cromado. Asiento giratorio en fundición AG3 pulido scotch y anodizado plata o mecanizado en haya maciza barnizada. Versión taburete bajo con ruedas.

Versión All Black (66cm y 77cm): estructura de acero pintada en anodic black y asiento en madera de haya teñida o aluminio pintado anodic black.

	CHROMED STEEL / ACERO CROMADO		ALL BLACK	
	Aluminium seat Asiento aluminio	Beech seat Asiento madera	Aluminium seat Asiento aluminio	Beech seat Asiento madera
<b>H. 45/48</b>	571	721	-	-
<b>H. 66/70</b> (Counter)	 530	695	491	695
<b>H. 77/80</b> (Bar)	 538	701	506	701

Aluminium / Aluminio

\*Consult conditions / Consultar condiciones

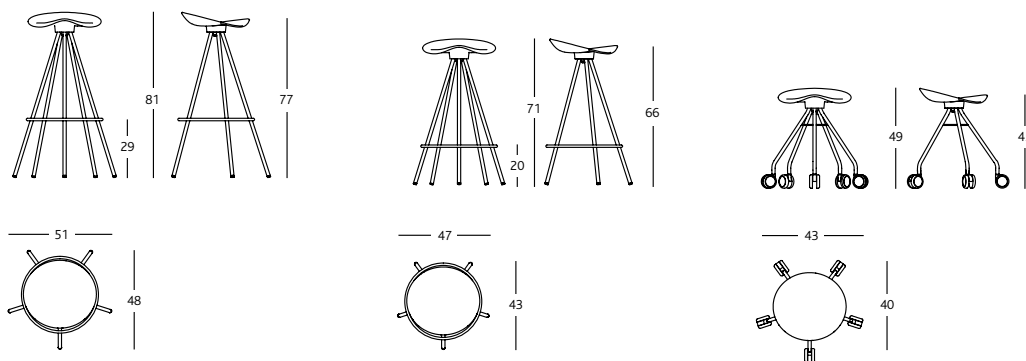

Wood / Madera

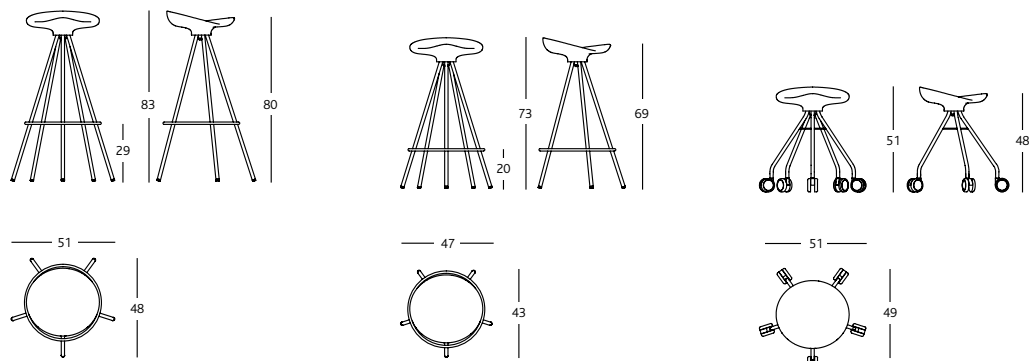

PACKAGING - ALUMINIUM / ALUMINIO

PACKAGING - WOOD / MADERA

	PCS	DIMENSIONS CM	GROSS KG		PCS	DIMENSIONS CM	GROSS KG
High / Alto	1	54 x 52 x 88	9	High / Alto	1	54 x 52 x 88	10
Medium / Medio	1	50 x 46 x 78	8	Medium / Medio	1	50 x 46 x 78	9
Low / Bajo	1	42 x 42 x 54	6	Low / Bajo	1	42 x 42 x 54	7



BINARIA STOOL / TABURETE 

Jordi Badia &amp; Otto Canalda

Steel structure and lever painted in a polyester powder coating and satin finish. Available in White RAL 1013, Red RAL 3002 or Black RAL 9005. Integral polyurethane injected seat. Gas piston for height regulation (200mm) in a polished steel finish. Castors in a reinforced polyamide and rubber grey rings.  
Estructura y maneta en acero, pintados con pintura de polvo poliéster satinado. Blanco RAL 1013, Rojo RAL 3002 y Negro RAL 9005. Asiento inyectado en poliuretano integral. Pistón de gas regulable en altura (200mm.) acabado acero pulido. Ruedas en poliamida reforzada con banda de goma gris.

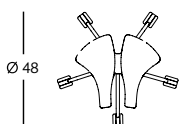
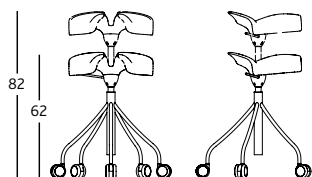

BINB040404	White / Blanco	
BINB070707	Red / Rojo	472
BINB101010	Black / Negro	

\*Consult conditions / Consultar condiciones

## PACKAGING

PCS	DIMENSIONS CM	GROSS KG
1	50 x 48 x 64	8

## GRASSO STOOL / TABURETE

Stephen Burks

Steel painted structure and seat upholstered in different materials and leathers provided by BD. The Bolon material is made of PVC and wool.  
Taburete con estructura de acero pintado y asiento tapizado con las distintos tejidos y pieles de BD. Tejido Bolon fabricado en PVC + lana.

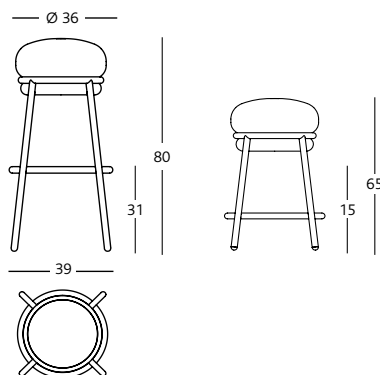

	Fabrics / Telas					Leather / Piel		
	*COM	CAT 1	CAT 2	CAT 3 / Y	CAT 4	P	S	V/F
<b>Medium / Mediano</b> (Counter)	699	756	779	808	842	848	899	922
<b>High / Alto</b> (Bar)	719	774	798	830	861	872	952	982

\*COM : Customer's own material / Tejido o piel del cliente

Metres of material required / Metros de material requerido

Leather / piel 1m<sup>2</sup> - Fabric / Tela 100 x 140 cm

For colours see Grasso armchair pag. 61

## PACKAGING

PCS	DIMENSIONS CM	GROSS KG
H.65 1	54 x 51 x 73	8
H.80 1	54 x 51 x 88	10

## JANET STOOL / TABURETE (until stocks lasts / hasta agotar existencias)

Ramon Úbeda &amp; Otto Canalda

Tubular chromed steel structure. Seat in a bright polished cast aluminium AG3 and anodised silver. Also available in an upholstered black leather version.  
Estructura de tubo en acero cromado. Asiento en fundición de aluminio AG3 pulido scotch y anodizado plata. Se puede tapizar el asiento en piel negra.

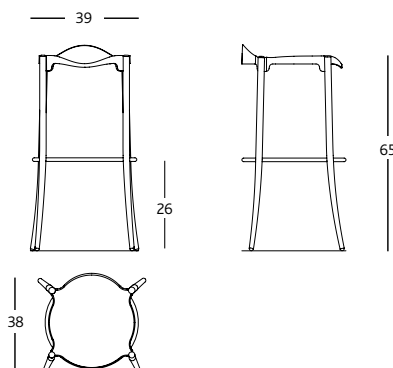

JNTAB65CR	Aluminium seat / Asiento aluminio	477
JNTAB65CRP10	Seat uph. leather / Asiento piel	757

## PACKAGING

PCS	DIMENSIONS CM	GROSS KG
1	45 x 45 x 72	6

## ACCESSORIES / ACCESORIOS

### MIRALLMAR MIRROR / ESPEJO

Eduard Samsó

A multi-mirror display made up of 7 separate squared double faced mirrors in different sizes with variable positions. Flat mirrors except one concave mirror. Structure, nuts + bolts and discs in zinc-coated iron.

*Multiespejo formado por 7 espejos cuadrados de diferentes medidas, con posición variable. Espejos planos a excepción de uno que es cóncavo. Estructura, casquillos y discos en hierro zincado.*

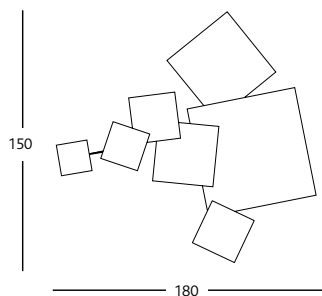

EM0398

Mirallmar mirror / espejo

1.820

### OTHER COMPOSITIONS / OTRAS COMPOSICIONES

2 standard units / 2 unidades estándar

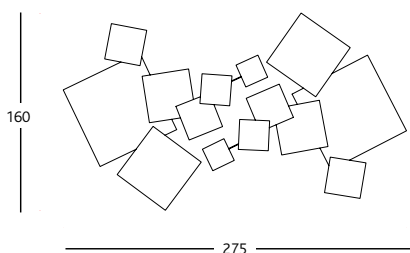

3 standard units / 3 unidades estándar

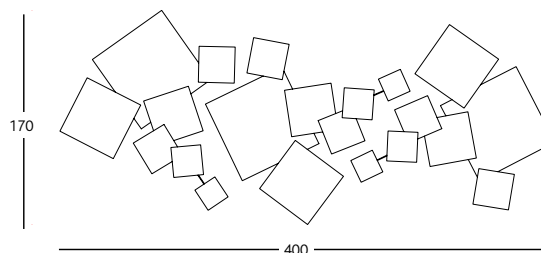

PACKAGING



Delta selection / Selección Delta 1992

PCS	DIMENSIONS CM	GROSS KG
1	130 x 90 x 60	26

### SHOWTIME MIRROR / ESPEJO

Jaime Hayon

A one-sided multi-mirror mural. The back of each mirror is painted in matte black.

*Mural multiespejo a una sola cara. La cara posterior siempre va pintada en negro mate.*

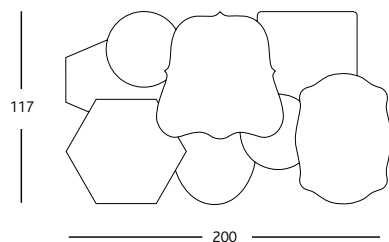

SWESPEJO

Showtime Multi-mirror / Multi Espejo Showtime

1.762

PACKAGING

PCS	DIMENSIONS CM	GROSS KG
1	100 x 65 x 100	42



## KING KONG MIRRORS / ESPEJOS

Jaime Hayon

Mirrors available in two sizes. Decorative patterns are applied in gold and black. The back of each mirror is covered with black vinyl.  
Espejos en dos tamaños diferentes, con decoraciones aplicadas en dorado y negro. Trasera cubierta con vinilo de seguridad negro.

## KING

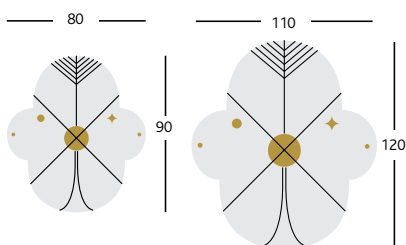

## KONG

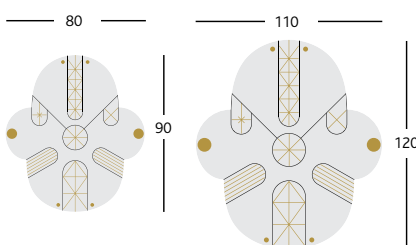

KING90SMALL	King 90 cm	912
KING120BIG	King 120 cm	1.320
KONG90SMALL	Kong 90 cm	1.077
KONG120BIG	Kong 120 cm	1.454

## PACKAGING

	PCS	DIMENSIONS CM	GROSS KG
Mirror 90	1	92 x 12 x 102	12
Mirror 120	1	128 x 12 x 138	20

SHIVA FLOWER VASE / FLORERO 

Ettore Sottsass Jr.

Pink glazed ceramic vase / Cerámica esmaltada en color rosa.

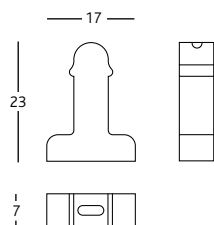

SH0439	Shiva	184
--------	-------	-----

## PACKAGING

\*Consult conditions / Consultar condiciones

	PCS	DIMENSIONS CM	GROSS KG
	1	12 x 33 x 24	3

## GARDENIAS VASES / JARRONES

Jaime Hayon

Terracotta and waterproof treated / Fabricados en terracota con un posterior tratamiento de impermeabilidad.

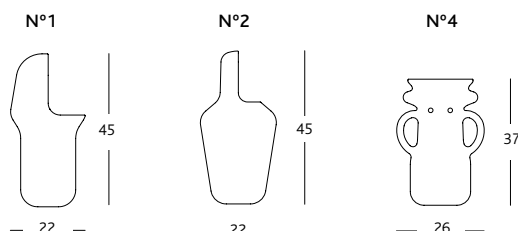

GARJAR01TER	N°1	273
GARJAR02TER	N°2	270
GARJAR04TER	N°4	307

## PACKAGING

	PCS	DIMENSIONS CM	GROSS KG
N°1, N°2, N°4	1	29 x 29 x 51	4

## SHOWTIME VASES / JARRONES

Jaime Hayon

Top and base glazed ceramic pieces. Monochromed (interior and exterior in white) or bi-coloured vases (interior in white and exterior available in standard colours).  
Fabricados en dos piezas en cerámica esmaltada; monocolor (interior y exterior en blanco) o bicolor (interior en blanco y exterior en varios colores, según el jarrón).

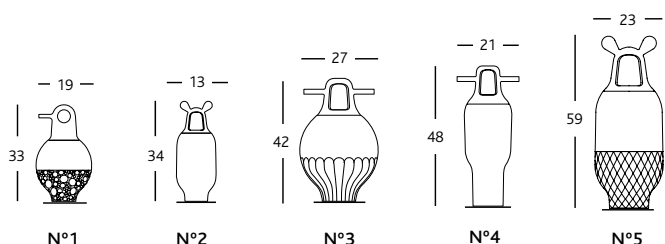

N°1

N°2

N°3

N°4

N°5



N°1



N°2



N°3



N°4



N°5

SWJAR1BL	N°1		337
SWJAR2BL	N°2	*	259
SWJAR3BL	N°3	Int. and Ext. white Int. y Ext. blanco	583
SWJAR4BL	N°4		344
SWJAR5BL	N°5		595

SWJAR1NG	N° 1 / Int. white - Ext. black N° 1 / Int. blanco - Ext. negro	522
SWJAR2AE	N° 2 / Int. white - Ext. electric yellow N° 2 / Int. blanco - Ext. amarillo eléctrico	370
SWJAR3VG	N° 3 / Int. white - Ext. greyish green N° 3 / Int. blanco - Ext. verde grisáceo	894
SWJAR4RR	N° 4 / Int. white - Ext. pink N° 4 / Int. blanco - Ext. rosa	522
SWJAR5AN	N° 5 / Int. white - Ext. Napoleon blue N° 5 / Int. blanco - Ext. azul Napoleón	894

## SHOWTIME 10 VASES / JARRONES \*

Manufactured in two pieces of enameled white ceramic and decorated in 24 carat gold painting.  
Fabricados en dos piezas de cerámica esmaltada en blanco, con decoraciones en pintura oro de 24 quilates.

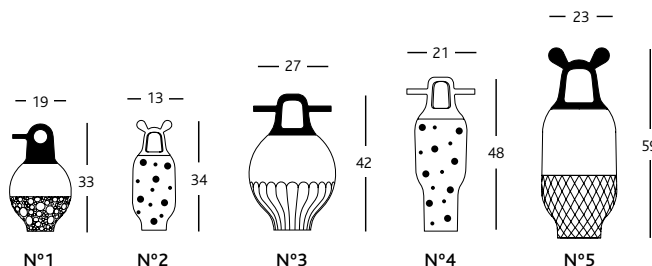

N°1

N°2

N°3

N°4

N°5

SWJAR110ANIV	N° 1 / White - Golden lid N° 1 / Blanco - Tapa dorada	446
SWJAR210ANIV	N° 2 / White with golden dots N° 2 / Blanco con puntos dorados	328
SWJAR310ANIV	N° 3 / White - Golden lid N° 3 / Blanco - Tapa dorada	747
SWJAR410ANIV	N° 4 / White with golden dots N° 4 / Blanco con puntos dorados	493
SWJAR510ANIV	N° 5 / White - Golden lid N° 5 / Blanco - Tapa dorada	786

\*Consult conditions / Consultar condiciones

The pieces cannot be sold separately.  
Las piezas no se pueden vender por separado.

### PACKAGING

	PCS	DIMENSIONS CM	GROSS KG
N°1	1	23 x 23 x 42	6
N°2	1	23 x 23 x 42	3
N°3	1	35 x 35 x 51	6
N°4	1	29 x 29 x 66	5
N°5	1	29 x 29 x 66	6





HAPPY SUSTO VASES / JARRONES 

Jaime Hayon

Glazed ceramic vase(s) in white or blue with decorations in white or blue. One side has the decoration and the other side does not.  
 Cerámica esmaltada en color blanco o azul con decoraciones en blanco o azul. Una cara con decoración, la otra cara sin.

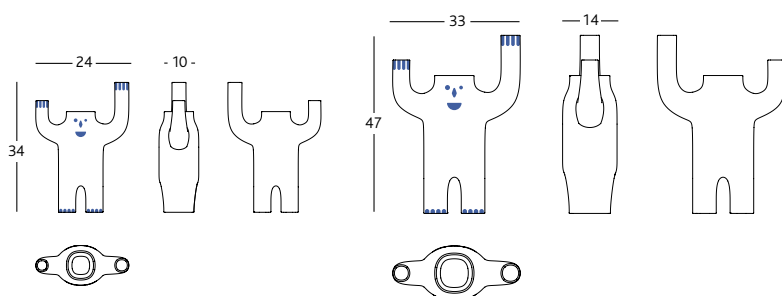

HSJARP04C/C	<b>Small White / Pequeño Blanco</b>	309
HSJARP09C/C	<b>Small Blue / Pequeño Azul</b>	386
HSJARG04C/C	<b>Large White / Grande Blanco</b>	518
HSJARG09C/C	<b>Large Blue / Grande Azul</b>	601

## PACKAGING

	PCS	DIMENSIONS CM	GROSS KG
Small / Pequeño	1	44 x 33 x 17	3
Large / Grande	1	57 x 42 x 21	4

\*Consult conditions / Consultar condiciones

HAPPY YETI VASES / JARRONES 

Jaime Hayon

Glazed ceramic vase in white and decorations in black.  
 Cerámica esmaltada en color blanco con decoración en negro.

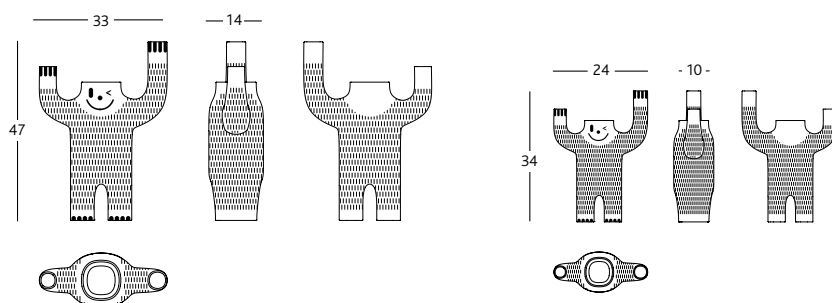

HSJARG04YETI	<b>Small / Pequeño</b>	482
HSJARP04YETI	<b>Large / Grande</b>	696

## PACKAGING

	PCS	DIMENSIONS CM	GROSS KG
Small / Pequeño	1	44 x 33 x 17	3
Large / Grande	1	57 x 42 x 21	4

\*Consult conditions / Consultar condiciones

## EXPLORER VASES / JARRONES

Jaime Hayon

Made of several pieces of glazed ceramic in different colors.  
 Fabricados en varias piezas de cerámica esmaltada en distintos colores.

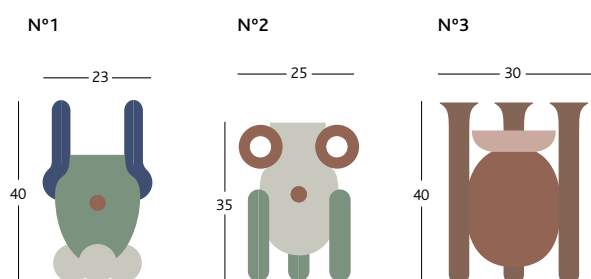

EXPJAR01COL	<b>N°1</b>	600
EXPJAR02COL	<b>N°2</b>	685
EXPJAR03COL	<b>N°3</b>	725

## PACKAGING

	PCS	DIMENSIONS CM	GROSS KG
N°1	1	292x292x462	4
N°2	1	292x292x462	4
N°3	1	352x392x470	4

## MONKEY COAT HANGER / PERCHERO

Jaime Hayon

Coat hanger: base in grey or black architectural concrete. Pole and banana in solid ash with an open-pore lacquer finish in gray or black. Includes regulatory glides.

Banana wall hanger: solid ash in grey, black or yellow.

*Perchero: cuerpo en hormigón arquitectónico gris o negro. Barra y banana en fresno macizo lacado a poro abierto en gris o negro. Incorpora tacos reguladores.*

*Colgador de pared Banana: fresno macizo en gris, negro o amarillo.*

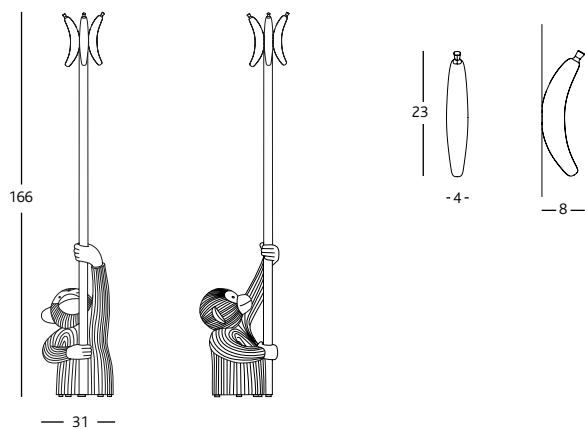

MKCOLG013	Coat hanger grey / Perchero Gris	1.385
MKCOLG010	Coat hanger black / Perchero Negro	1.425
	Banana wall hanger / Colgador pared	145

Maximum load on each hanger / Carga máxima sobre cada colgador:

Coat hanger / Perchero: 4 kg

Banana: 4 kg



PACKAGING			
	PCS	DIMENSIONS CM	GROSS KG
Hanger / Colgador	1	60 x 60 x 85	5
Banana	1	4 x 8 x 24	2

## CASA DE FAMILIA BOTTLE / BOTELLA

Josep Maria Jujol

Transparent or blue glass. Approximate capacity per bottle: 1.2L.

*Vidrio transparente o azul. La capacidad aproximada de las botellas es de 1,2l.*

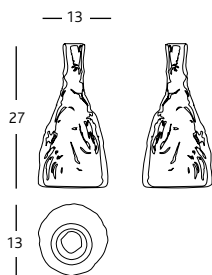

JU0300	Transparent / Transparente	119
JU0301	Blue / Azul	133

PACKAGING		
	PCS	DIMENSIONS CM
	1	14 x 14 x 24
		GROSS KG
		0.5



## HAPPY HOUR TROLLEYS / CARRITOS

Alfredo Häberli

Chromed iron structure. Heat-shaped ABS trays, painted in textured polyurethane in white matte (RAL 9003) or black (RAL 9005).  
Back wheels in chromed iron and rubber gasket.

Estructura en hierro cromado. Bandejas en ABS termoconformado pintado en poliuretano texturizado mate color blanco RAL 9003 o negro RAL 9005.  
Ruedas traseras en hierro cromado con junta de caucho.

## Servicetable

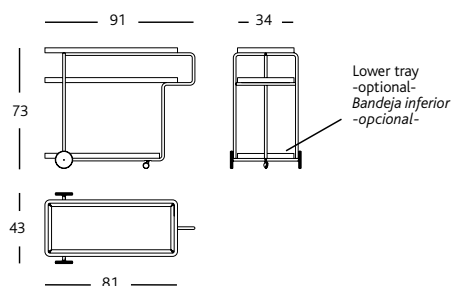

## SERVICETABLE

HH2002	Trays painted white matte RAL 9003 Bandejas pintadas blanco mate RAL 9003	1.556
HH2003	Trays painted black matte RAL 9005 Bandejas pintadas en negro mate RAL 9005	

## SERVICEBAR

HH3006	Trays painted white matte RAL 9003 Bandejas pintadas blanco mate RAL 9003	1.556
HH3007	Trays painted black matte RAL 9005 Bandejas pintadas en negro mate RAL 9005	

## Servicebar

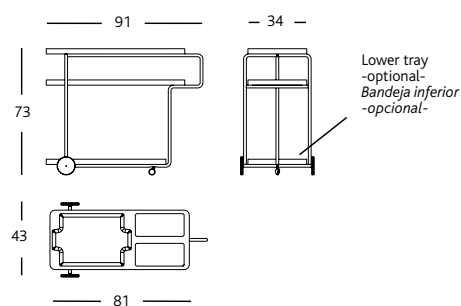

## LOWER TRAY (OPTIONAL) / BANDEJA INFERIOR (OPCIONAL)

HH3004	Trays painted white matte RAL 9003 Bandejas pintadas blanco mate RAL 9003	244
HH3005	Trays painted black matte RAL 9005 Bandejas pintadas en negro mate RAL 9005	

## PACKAGING

PCS	DIMENSIONS CM	GROSS KG
1	120 x 50 x 100	17

PLEC UMBRELLA STAND / PARAGÜERO 

Isabel Gamero &amp; Jordi Pérez

Main body in semi-matte polished stainless steel. Polyester foam placed on the inside base.

Cuerpo en acero inoxidable pulido semimate. Espuma de poliéster en la base interior.

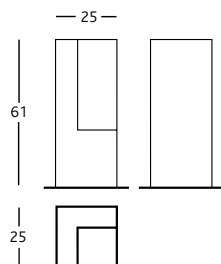

PL0757	Plec	683
--------	------	-----

\* Consult conditions / Consultar condiciones



Delta selection / Selección Delta 1997

## PACKAGING

PCS	DIMENSIONS CM	GROSS KG
1	28 x 28 x 70	10

### 3-4-5 MAILBOX / BUZÓN

Lluís Clotet & Oscar Tusquets

Made up of steel sheets painted in a black polyester powder coating (RAL 9005). Doors in polished stainless steel with a transparent acrylic window and white labelling card.

Cuerpo en chapa de acero pintada en polvo poliéster negro RAL 9005. Puertas en chapa de acero inoxidable pulido con visores de metacrilato transparente y etiquetas en cartulina blanca.

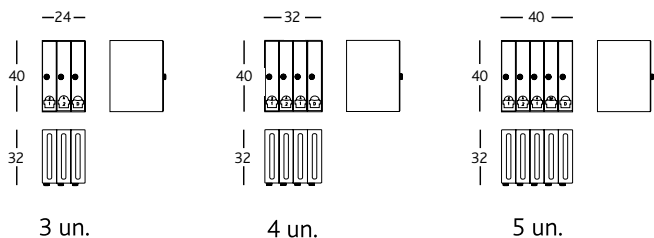

BZ0497	3 un.	586
BZ0498	4 un.	702
BZ0499	5 un.	807

- Includes two keys per module
- For installations between walls, it is advisable to leave a space of between 1-2 cm of the total length for tolerance.
- For the mailbox 3un. total measure should be 24,5cm
- For the mailbox 4un. total measure should be 32,5cm
- For the mailbox 5un. total measure should be 40,5cm

- Incluye dos llaves por buzón
- Para instalaciones entre paredes, se aconseja dejar una tolerancia de 1 a 2 cm. de la medida total.
- Para el buzón 3un. medida total debe ser 24,5cm
- Para el buzón 4un. medida total debe ser 32,5cm
- Para el buzón 5un. medida total debe ser 40,5cm



Delta selection / Selección Delta 12005

#### PACKAGING

	PCS	DIMENSIONS CM	GROSS KG
Mailbox / Buzón 3	1	30 x 36 x 46	6
Mailbox / Buzón 4	1	38 x 36 x 46	8
Mailbox / Buzón 5	1	46 x 36 x 46	9



## DIAFANA HOOD / CAMPANA DIÁFANA

Lluís Clotet &amp; Oscar Tusquets

Extractor motor, tubes, flexi-tubes, reducer and the grease collecting tray are all in polished stainless steel, flexible pipes and filter in aluminium, and a cast aluminium wall fixture. The extractor hood is in a transparent metacrylate. Rubber joints and supports are oil-resistant.

*Carcasa motor, tubos de salida, codos, reductor y cubeta recoge grasas en acero inoxidable pulido. Tubo flexible y filtro en aluminio. Soporte pared en fundición de aluminio. Campana en metacrilato transparente. Juntas y soportes de campana en caucho nitrílico resistente al aceite.*

## Hood / Campana

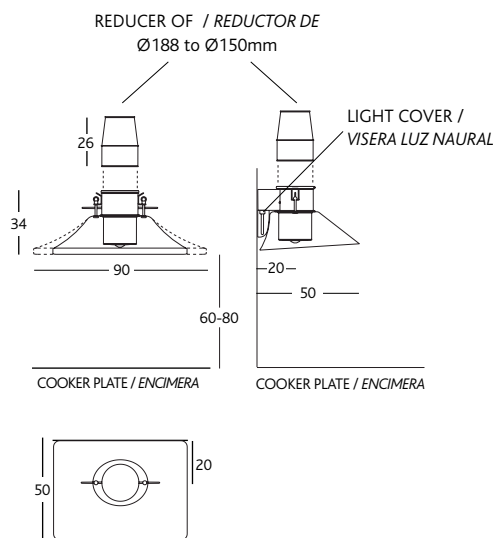

## METHACRYLATE HOOD / CAMPANA DE METACRILATO

CD0801	<b>90cm</b>	2.358
--------	-------------	-------

- The hood includes a reducer of  $\varnothing 188$  to  $\varnothing 150$ mm.
- Double speed extractor.
- Speed: 2500rpm or 1850 rpm
- Maximum power consumption: 68w - 50w
- Maximum current consumption: 0,30A - 0,22A
- Unimpeded air flow: 535m<sup>3</sup>/h - 400 m<sup>3</sup>/h
- Maximum functioning temperature: 60°C
- Sound pressure level: 41db - 33db

- *La campana incluye el reductor de  $\varnothing 188$  a  $\varnothing 150$ mm.*
- *Extractor heliocentrífugo de dos velocidades con las siguientes características:*
- *Velocidades: 2500rpm - 1850 rpm.*
- *Potencia absorbida máxima: 68w - 50w.*
- *Intensidad absorbida máxima: 0,30A - 0,22A.*
- *Caudal en descarga libre: 535m<sup>3</sup>/h - 400 m<sup>3</sup>/h.*
- *Temperatura máxima de trabajo: 60°C.*
- *Nivel de presión sonora: 41db - 33db.*

CD0803	<b>Light cover (optional)</b>	76
--------	-------------------------------	----

- In polished stainless steel.
- Linestra G-23 9W included.

**Visera luz lateral (opcional)**

- *En acero inoxidable pulido.*
- *Incluye linestra G-23 9W.*

## Tubes / Tubos

$\varnothing 188$ mm

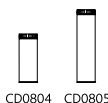

CD0804 CD0805

## TUBES &amp; FLEXIBLE-TUBES / TUBOS Y CODOS

CD0804	<b><math>\varnothing 188</math>mm x 500mm</b>	121
--------	---	-----

CD0805	<b><math>\varnothing 188</math>mm x 750mm</b>	
--------	---	--

## INSTALLATION / INSTALACIÓN

**Installation through a roof / wall / furniture**

**Salida a través de un techo / pared / mueble**

## Trim rings / Embellecedores



CD0825

CD0826

## Reducer / Reductor



CD0822

CD0825	<b><math>\varnothing 150</math>mm tube end ring</b>	59
--------	---	----

**Aro de remate para tubo de  $\varnothing 150$ mm**

CD0826	<b><math>\varnothing 188</math>mm tube end ring</b>	58
--------	---	----

**Aro de remate para tubo de  $\varnothing 188$ mm**

CD0822	<b>Reducer of <math>\varnothing 150</math>mm to <math>\varnothing 120</math>mm</b>	166
--------	--	-----

**Reductor de  $\varnothing 150$ mm a  $\varnothing 120$ mm**

If the tube goes through the ceiling, the wall or a piece of furniture, etc., you can request trim rings.

If the smoke extractor goes through a wall,  $\varnothing 188$ mm or  $\varnothing 150$ mm tubes, and flexi-tubes (not including the reducer as this is already included in the extractor) measurements must be calculated.

*Si los tubos atraviesan el cielo raso, el muro, un mueble, etc, puede solicitar aros embellecedores.*

*Si la salida de humos va directa a techo, deben calcularse el número y precio de los tubos de  $\varnothing 188$ mm o  $\varnothing 150$ mm que sean necesarios.*

*Si la salida de humos es a través de la pared, deben calcularse el número de tubos de  $\varnothing 188$ mm (antes del reductor, el cual ya está incluido en la caja de la Campana), el número de tubos de  $\varnothing 150$ mm después del reductor y el codo necesario elegido.*



Silver Delta Award / Premio Delta Plata 1997

# LIGHTING / ILUMINACIÓN

## FLAMINGO LAMP / LÁMPARA

Álvaro Siza Vieira

Chromed iron bar structure which can be disassembled. Adjustable fine aluminium wings. Painted in a silver matte grey to control light. Dimmer included.  
Estructura desmontable en varilla de hierro cromado. Aletas orientables para el control de la luz en aluminio pintado gris plata mate. Incluye Dimmer.

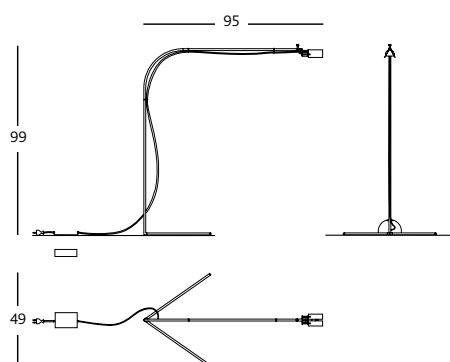

FL0100

Flamingo Lamp / Lámpara

1.115

- One LED bulb 9W G9, included.
- Power 9W - 350 lumens - T 3000K.
- Certified CE UNE-EN 60598-1.
- Energetic value A+

- Incluye 1 bombilla LED 9W G9.
- Potencia 9W - 350 lumens - T 3000K.
- Certificado CE UNE-EN 60598-1.
- Valor energético A+

### PACKAGING

PCS	DIMENSIONS CM	GROSS KG
1	107 x 32 x 4	4

## OLVIDADA LAMP / LÁMPARA

Pepe Cortés

Standing and ceiling lamps in a copper polished rigid tube finish and chromed lampholder. The black cable hanging lamp version (maximum length of 3m) is made up of the lampholder (attached to the electric cable) and a metal brass scotch polished rosette. Also available with a chromed metal lampholder and black anodic black rosette.

Rigid brass finished structures, scotch polished and varnished for the double, triple and chandelier hanging lamps with lampholders and rosettes in the same finish. All lamps include Led 7W linestras.

Lámpara de pie y suspensión rígida, en estructura cobreada y dado portalámpara cromado. Lámpara de suspensión de cable (longitud max 3m), con florón y dado portalámpara en acabado latonado pulido scotch barnizado, o versión en acabado florón pintado en color anódico black y dado portalámpara cromado. Lámpara Doble, Triple, Chandelier tanto en florón y dado portalámpara en acabado como el resto de la estructura, acabado latonado pulido scotch y barnizado. Portalámparas con linestras de led de 7W.

Bulbs included / Bombillas incluidas

OLSUSLATB	 A. Pending black cable lamp with brass finished rosette De suspensión con cable negro y florón en metálico latonado	784
OLSUSANBB	A. Pending black cable lamp with rosette in Anodic Black De suspensión con cable negro y florón en Anodic Black	849
OLSIMCOBB	B. Pending lamp with tube in copper finish De suspensión rígida cobreada	960
OLPIECOBB	C. Standing lamp in copper finish De pie cobreada	1.171
OLDOBLATB	D. Double /Doble	1.790
OLTRILATB	E. Triple	2.621
OLCHALATB	F. Chandelier	4.092
ST4061	Set of 3 led bulbs / Set de 3 bombillas LED S140/7W/UNIT-220-240V	140
ST6784	Dimmer (optional for standing lamp / opcional para lámpara pie)	182
	1 Converter from 220v to 110v (standing)	199
	1 Converter from 220v to 110v (pending)	222

\*Consult conditions / Consultar condiciones



**A. Pending lamp with black cable**  
*De suspensión con cable negro*

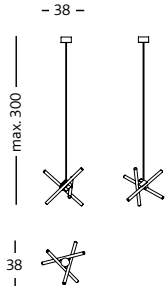

**B. Pending lamp with rigid tube**  
*De suspensión rígida*

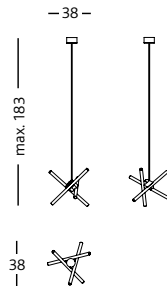

**C. Standing lamp**  
*De pie*

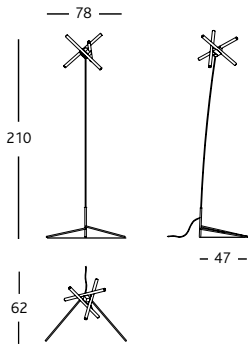

**D. Double / Doble**

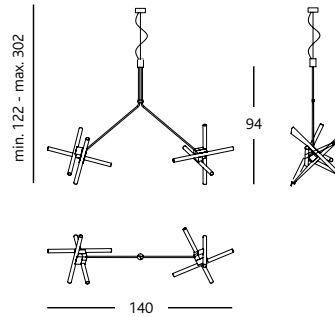

**E. Triple**  
(Until stocks last / *Hasta agotar existencias*)

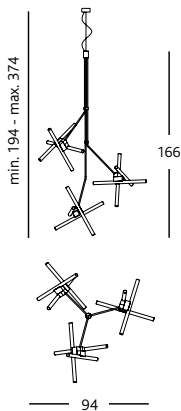

**F. Chandelier**  
(Until stocks last / *Hasta agotar existencias*)

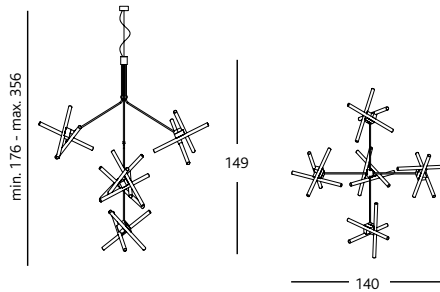

- 3 led linestras S140/7W/UNIT-220-240V
- Power 7W - 470 lumens - T2700K
- Regulation "Dimmable"
- Certified CE UNE-EN 60598-1
- Energetic value A+

- 3 bombillas led S140/9W/UNIT-220-240V
- Potencia 7W - 470 lumens - T 2700K
- Regulación "Dimmable".
- Certificación CE UNE-EN 60598-1
- Valor energético A+

PACKAGING			
	PCS	DIMENSIONS CM	GROSS KG
Standing / <i>De pie</i>	1	196 x 13 x 13	6
Pending lamp / <i>De suspensión rígida</i>	1	196 x 13 x 13	7
Hanging cable / <i>De suspensión cable</i>	1	20 x 20 x 20	1,5
Double / <i>Doble</i>	1	118 x 93 x 18	9
Triple	1	152 x 48 x 26	12
Chandelier	1	116 x 85 x 18	17

# PUBLIC SEATING / ASIENTOS PÚBLICOS

## THE POET BENCH / BANCO EL POETA

Alfredo Häberli

Steel tubular legs and steel sheets for seating, covered in cataphoresis and painted in polyester resin in a corten colour, or in microtexturised silver (RAL 9006).

*Patasy asiento en tubo y plancha perforada de acero, con recubrimiento en cataforesis y pintado en resina de poliéster color corten o plata (RAL 9006) microtexturado.*

### The Poet / El Poeta - Flowers

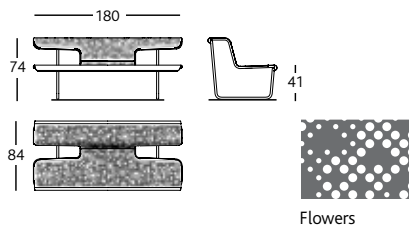

### FLOWERS

Code	Material	Price
BS0101	Corten	
BS0301	Silver Grey / Plata	3.276

### The Poet / El Poeta - Basic

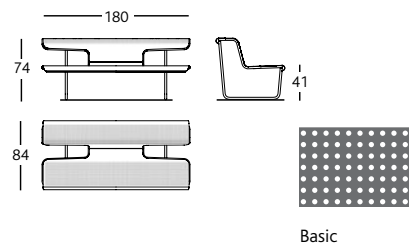

### BASIC

Code	Material	Notes
BS0401	Corten	Request price and delivery time for a minimum of 50 un.
BS0501	Silver Grey / Plata	Solicitar precio y plazo de entrega a partir de 50 un.

- Benches should always be screwed to the ground.
- Fixing materials are not included.
- Siempre deben ir atornillados al suelo.
- No incluyen tornillos de sujeción al suelo.



### PACKAGING

PCS	DIMENSIONS CM	GROSS KG
1	200 x 100 x 64	40





**BENCH B***Konstantin Grcic*

Extruded anodised aluminium slats. Legs and armrests in cast aluminium and painted in silver grey (RAL 9006). Optional upholstery for indoor and outdoor use. Optional armrests.

*Perfiles en aluminio extrusionado anodizado. Pies y brazos en fundición de aluminio pintados gris plata (RAL 9006). Puede tapizarse para uso en interiores y exteriores. Brazos opcionales.*

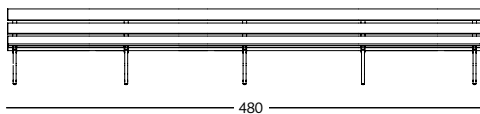
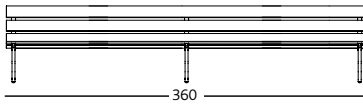
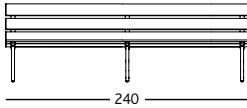
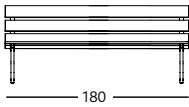
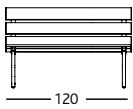
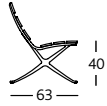

	ALUMINIUM / ALUMINIO	Fabrics / Telas				Leather / Piel	
		CAT 1	CAT 2	CAT 3 / Y	CAT 4	P	V/F
<b>3 seater / 3 plazas (180 cm)</b>	2.075	3.490	3.580	3.670	3.805	3.985	4.165
<b>4 seater / 4 plazas (240 cm)</b>	2.740	4.535	4.655	4.775	4.955	5.195	5.435
<b>6 seater / 6 plazas (360 cm)</b>	3.440	5.995	6.175	6.355	6.625	6.985	7.345

**Arm / Brazo (optional /opcional) 165**

**2 seater / 2 plazas (120 cm)**

Only for projects. Prices on request.

**8 seater / 8 plazas (480 cm)**

*Sólo para proyectos. Consultar precios.*

## CATALANO & PERFORANO BENCH / BANCO

PERFORANO: Tubular steel seating in perforated sheets with a cathoresis covering and painted in silver-coloured polyester resin. Optional armrests in painted steel.

CATALANO: Tubular steel seating in deployé and hot dip galvanized. Additionally, the galvanized deployé can be painted over with a silver-coloured polyester resin.

Optional: Tubular steel and galvanized armrests, or galvanized and painted.

PERFORANO AND CATALANO LEGS: tubular steel, galvanized or galvanized and painted.

PERFORANO: Asiento en tubo y chapa perforada de acero con recubrimiento en cataforesis y pintado en resina de poliéster color plata. Brazo opcional en acero pintado.

CATALANO: Asiento en tubo y chapa deployé de acero con un galvanizado en caliente. Adicionalmente se puede pintar encima del galvanizado en resina de poliéster color plata. Brazo opcional en plancha de acero galvanizado o galvanizado y pintado.

PATAS PERFORANO Y CATALANO: en tubo de acero galvanizado o galvanizado y pintado.

### CATALANO



Malla Deployé

### PERFORANO



Perforated / Perforada

### SEAT / ASIENTOS

BC0460	CATALANO galvanized / <i>galvanizado</i>	830
BC0511	CATALANO galvanized and painted / <i>galvanizado y pintado</i>	987
BC0472	PERFORANO painted / <i>pintado</i>	856

### GALVANIZED LEG / PATA GALVANIZADA

BC0462	Single leg to hang <i>Pata sencilla para colgar</i>	182
BC0463	Single leg to build into the floor <i>Pata sencilla para empotrar</i>	154
BC0461	Single leg free-standing, to be screwed into the floor <i>Pata sencilla para apoyar - atornillar</i>	198
BC0464	Double leg free-standing, to be screwed into the floor <i>Pata doble para apoyar - atornillar</i>	220
BC0465	Double leg to build into the floor <i>Pata doble para empotrar</i>	220

### GALVANIZED AND PAINTED LEG / PATA GALVANIZADA Y PINTADA

BC0512	Single leg to hang <i>Pata sencilla para colgar</i>	215
BC0513	Single leg to build into the floor <i>Pata sencilla para empotrar</i>	182
BC0514	Single leg free-standing, to be screwed into the floor <i>Pata sencilla para apoyar - atornillar</i>	237
BC0515	Double leg free-standing, to be screwed into the floor <i>Pata doble para apoyar - atornillar</i>	254
BC0516	Double leg to build into the floor <i>Pata doble para empotrar</i>	254

### ARMS (optional) / BRAZOS (opcional)

BC0517	CATALANO galvanized / <i>galvanizado</i>	187
BC0518	CATALANO galvanized and painted / <i>galvanizado y pintado</i>	220
BC0504	PERFORANO painted steel / <i>en acero pintado</i>	228

#### PACKAGING

	PCS	DIMENSIONS CM	GROSS KG
CATALANO 1 unit / <i>unidad</i>	1	98 x 36 x 106	16
PERFORANO 1 unit / <i>unidad</i>	1	98 x 36 x 126	16

Details on request / *Consultar*



Selección Delta 1974



CATALANO

To hang / Para colgar

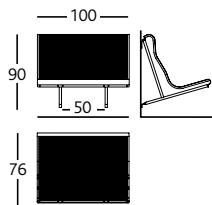

To build into the floor  
Para empotrar

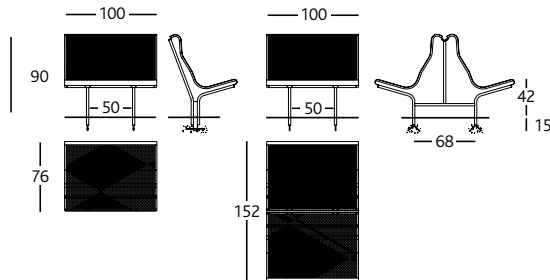

Free-standing to be screwed into the floor  
Para apoyar - atornillar

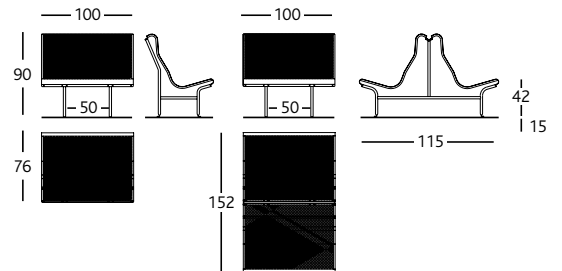

Optional armrests  
Brazos opcionales



PERFORANO

To hang / Para colgar

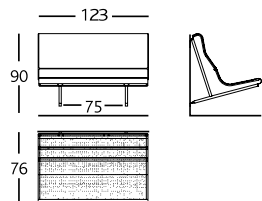

Simple leg Free-standing to be  
screwed into the floor  
Pata sencilla para apoyar - atornillar

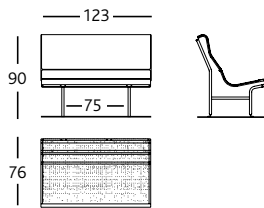

Simple leg to build into the floor  
Pata sencilla para empotrar

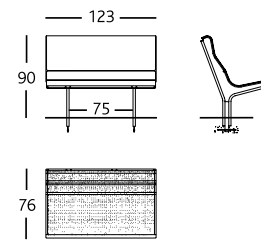

Double leg Free-standing to be  
screwed into the floor  
Pata doble para apoyar - atornillar

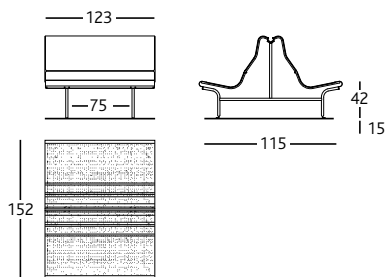

Double leg to build into the floor  
Pata doble para empotrar

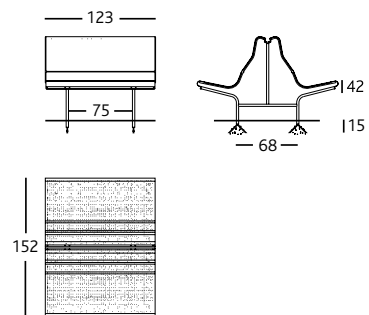

Optional armrests  
Brazos opcionales





The ART EDITIONS collection are sculptural parts, so they must be handled very carefully. These products are not subject to tests for use, stability or any other aspect. For this reason, BD cannot be held responsible for damage caused to the Art Editions piece or to third parties due to improper use.

*La colección ART EDITIONS son piezas escultóricas, por lo que su uso debe de realizarse con cuidado; estos productos no están sujetos a test de ensayos ni de estabilidad. Por tanto, BD no se hace responsable de los daños causados en la pieza o a terceros por un uso inadecuado.*

# GAUDÍ FURNITURE / MOBILIARIO

GAUDÍ FURNITURE items are made of solid wood, following the techniques that were used in the construction and carving of the original pieces. This process classifies the Gaudí furniture collection as sculptural art.

**CONSERVATION AND MAINTENANCE:** Furniture should be placed in areas with stable temperatures between 15-35 degrees Celcius and a humidity of 40 - 60%. Extreme changes in temperature and or humidity have a direct influence on the behaviour of material. Wood, being a natural (living) element, dilates or contracts, (absorbs or releases moisture). The parameter changes mentioned depend directly on the location of the furniture in the customer's home or improper storage.

BD Barcelona cannot be held responsible for constructive alterations caused by extreme changes as detailed above.

As for maintenance, only a natural wax product with a cotton cloth, or passing the surface gently with a dry cotton cloth should be used.

Do not use abrasive products or solvents.

*Los MUEBLES GAUDÍ están fabricados en madera maciza, siguiendo las técnicas que se emplearon en la construcción y talla de los originales.*

*Este proceso clasifica al mobiliario Gaudí de escultura.*

**CONSERVACIÓN Y MANTENIMIENTO:** los muebles deben colocarse en áreas con temperaturas estables de 15-35°C y una humedad de 40-60%.

*Los cambios extremos de temperatura y/o humedad influyen directamente en el comportamiento de la materia, al ser un elemento natural (vivo) la madera se dilata o se contrae (absorbe o desprende humedad). Los cambios de parámetros mencionados dependen directamente de la ubicación del mueble en casa del cliente o de un almacenamiento indebido.*

*BD Barcelona no puede responsabilizarse de las alteraciones constructivas ocasionadas por los cambios extremos antes detallados.*

*Para el mantenimiento sólo necesita aplicarse un producto de ceras naturales con un paño de algodón o pasando un paño de algodón seco.*

*No utilizar productos abrasivos o disolventes.*

STORAGE AND SHELVING  
ESTANTERÍAS Y CONTENEDORES

TABLES  
MESAS

ARMCHAIRS  
BUTACAS

CHAIRS AND STOOLS  
SILLAS Y TABURETES

ACCESSORIES  
ACCESORIOS

LIGHTING  
ILUMINACIÓN

PUBLIC SEATING  
ASIENTOS PÚBLICOS

ART EDITIONS

## CALVET HANGER / COLGADOR

Antoni Gaudí

Waxed natural solid oak wood. Forged iron structure with a burnished copper and varnished finish.

*Madera de roble con encerado natural. Estructura de hierro forjado bruñido en bronce y barnizado.*

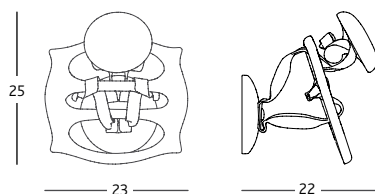

HG0051

1.023

PACKAGING		
PCS	DIMENSIONS CM	GROSS KG
1	32 x 28 x 26	2

## CALVET STOOL / TABURETE

Antoni Gaudí

Solid oak varnished / *Roble macizo barnizado.*

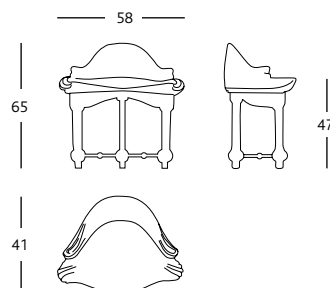

MG0003

5.375

PACKAGING		
PCS	DIMENSIONS CM	GROSS KG
1	70 x 60 x 86	36

## CALVET ARMCHAIR / SILLÓN

Antoni Gaudí

Solid dark varnished oak or natural (colourless) varnished / *Roble macizo barnizado o barnizado natural.*

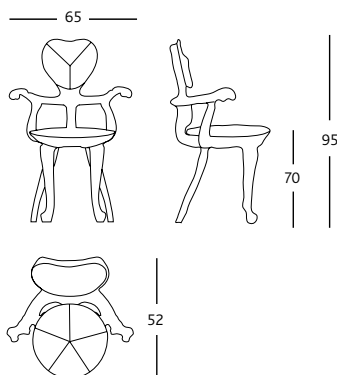

MG0006	Stained oak and varnished / <i>Roble teñido y barnizado</i>	9.440
MG0026	Oak with natural wax / <i>Roble encerado natural</i>	

### PACKAGING

PCS	DIMENSIONS CM	GROSS KG
1	119 x 78 x 65	42

## CALVET CHAIR / SILLA

Antoni Gaudí

Solid oak varnished / *Roble macizo barnizado.*

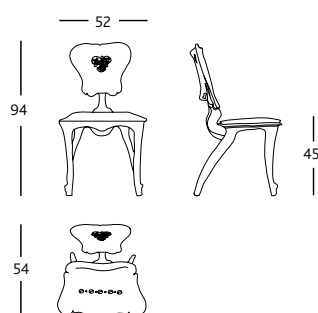

MG0009		7.339
--------	--	-------

### PACKAGING

PCS	DIMENSIONS CM	GROSS KG
1	60 x 60 x 100	35

## CALVET MIRROR / ESPEJO

Antoni Gaudí

Solid oak varnished or coated in fine golden brass sheets using a gold leaf technique / *Roble macizo barnizado o recubierto con láminas de latón doradas mediante técnica de pan de oro.*

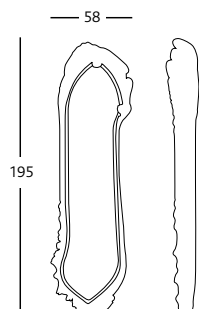

MG0001	Stained oak and varnished / <i>Roble teñido y barnizado</i>	13.880
MG0002	Covered in fine golden brass sheets <i>Recubierto con láminas de latón doradas</i>	18.725

### PACKAGING

PCS	DIMENSIONS CM	GROSS KG
1	203 x 74 x 26	78

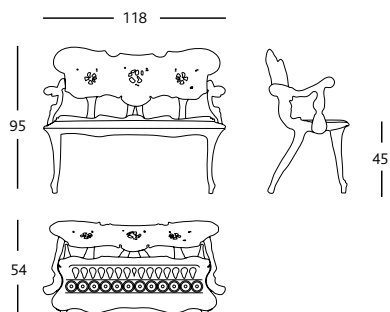
**CALVET BENCH / BANCO***Antoni Gaudí*Solid oak varnished / *Roble macizo barnizado.*

MG0008

18.947

PACKAGING		
PCS	DIMENSIONS CM	GROSS KG
1	125 x 60 x 110	50

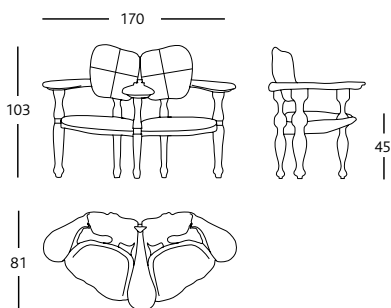
**BATLLÓ BENCH / BANCO***Antoni Gaudí*Solid dark varnished oak or natural (colourless) varnished / *Roble macizo teñido barnizado o barnizado natural.*MG0007 Stained oak and varnished / *Roble teñido y barnizado*MG0027 Oak with natural wax / *Roble encerado natural*

16.252

PACKAGING		
PCS	DIMENSIONS CM	GROSS KG
1	94 x 183 x 129	70

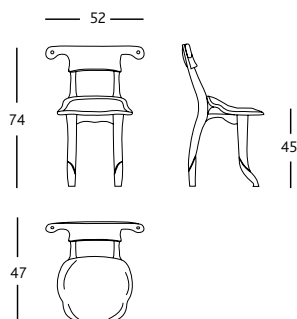
**BATLLÓ CHAIR / SILLA***Antoni Gaudí*Solid oak varnished / *Roble macizo barnizado.*

MG0004

4.595

PACKAGING		
PCS	DIMENSIONS CM	GROSS KG
1	60 x 63 x 87	50

## GAUDÍ DOOR KNOBS / HERRAJES

Antoni Gaudí

Solid cast brass and polished finish. Note: Polished brass tends to darken with time  
Fundición de latón macizo con acabado pulido. Nota: el latón pulido con el tiempo tiende a oscurecer.

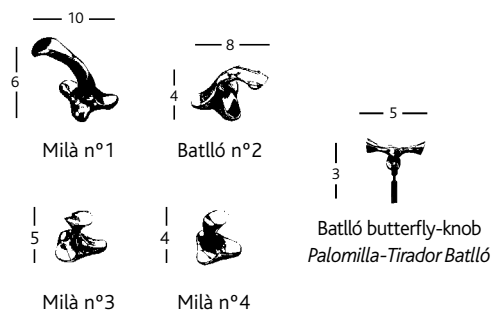

### DOOR KNOBS / TIRADORES

HG0008	Milà n°1	129
HG0012	Batlló n°2	114
HG0016	Milà n°3	111
HG0020	Milà n°4	101
HG0124	Batlló butterfly - knob / Tirador Batlló	80



### BUTTERFLY / PALOMILLAS

HG0024	Batlló Butterfly / palomilla (turns / con giro)	84
--------	---	----

### DOOR HANDLE / MANUBRIOS

HG0032	2 units / 2 unidades	242
--------	----------------------	-----

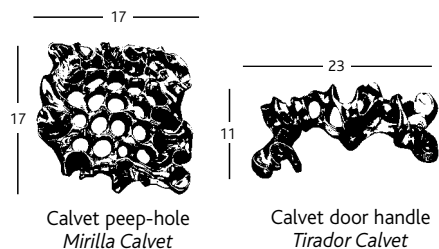

HG0040	Calvet peep-hole / Mirilla Calvet	2.191
HG0044	Calvet door handle / Tirador Calvet	2.208

\* Consult conditions / Consultar condiciones

## GAUDÍ HANDLES DISPLAY / EXPOSITOR

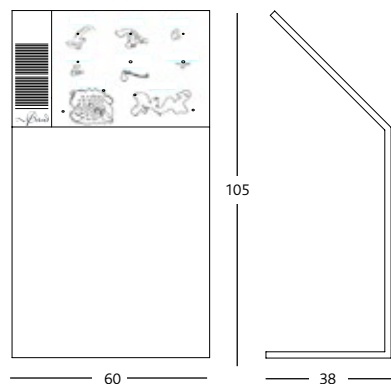

HG0008 - Milà n°1	129
HG0012 - Batlló n°2	114
HG0016 - Milà n°3	111
HG0020 - Milà n°4	101
HG0024 - Batlló butterfly	84
HG0099 - 1 Unit Handle	121
HG0040 - Calvet peep-hole	2.191
HG0044 - Calvet door handle	2.208
<b>Total</b>	<b>5.059</b>

### PACKAGING

PCS	DIMENSIONS CM	GROSS KG
1	66 x 44 x 121	25





# DALÍ FURNITURE / MOBILIARIO - ORIGINAL & BLACK LABEL COLLECTION

© SALVADOR DALÍ / FUNDACIÓN GALA-SALVADOR DALÍ, BARCELONA, 2022

STORAGE AND SHELVING  
ESTANTERÍAS Y CONTENEDORES

TABLES  
MESAS

ARMCHAIRS  
BUTACAS

CHAIRS AND STOOLS  
SILLAS Y TABURETES

ACCESSORIES  
ACCESORIOS

LIGHTING  
ILUMINACIÓN

PUBLIC SEATING  
ASIENTOS PÚBLICOS

ART EDITIONS

## PORTLLIGAT SUNBED / TUMBONA

Salvador Dalí

Solid Iroko wooden structure with polyamide wheels. Optional upholstered cushion with water repellent foam and material apt for outdoor use. The cover is removable.

Estructura de madera maciza de iroko con protección de aceite. Ruedas de poliamida y tornillería en acero inoxidable. Colchoneta opcional desfundable tapizada con espuma hidrófuga y tejido apto para uso exterior.

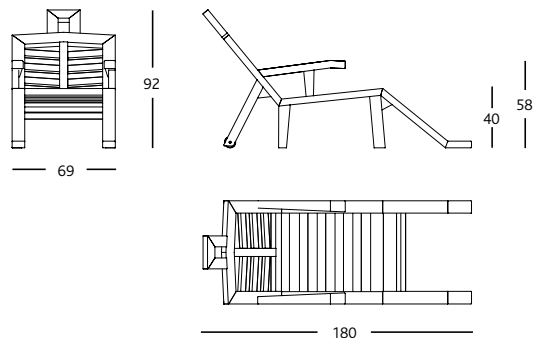

DATUMBONA	Portlligat sunbed / Tumbona	7.665
DACOLTUMB	Cushion / Colchoneta	655
DAFUNTUMB	Protective cover / Funda protectora	586

### CLEANING AND MAINTENANCE

The WOOD should be cleaned with a damp cloth and or with neutral soap. Do not use cleaning products containing alcohol, solvents or any of their derivatives. BD recommends applying teak oil twice a year for good wood maintenance. Always apply the teak oil with a brush and when the wood is dry. It is recommended to cover the sun lounger with a cover in rainy and out-of-use seasons. FABRICS should be cleaned with a damp cloth and or with neutral soap. In case of difficult stains, a mixture of bleach (40%) and water (60%) can be applied.

### LIMPIEZA Y MANTENIMIENTO

MADERA: Se debe limpiar con un paño húmedo y/o con jabón neutro. No utilizar productos de limpieza con alcoholes y disolventes o sus derivados. BD recomienda aplicar aceite de teca 2 veces al año para un buen mantenimiento de la madera. Aplicar con pincel o brocha siempre con la madera bien seca. TEJIDO: Se debe limpiar con un paño húmedo y/o con jabón neutro. En caso de manchas difíciles se puede aplicar una mezcla de lejía 40% y agua 60%. Se recomienda tapar la tumbona con una funda en temporadas de lluvia y fuera de uso.

### PACKAGING

PCS	DIMENSIONS CM	GROSS KG
1	190 x 80 x 100	35

## VIS-À-VIS DE GALA

Salvador Dalí

Structure in solid wood. Wooden socket lined with a polished lacquered brass strip. 100% natural silk cover and buttons in parma violet colour or black satin. Upper trim (backrest) in a cast polished and varnished brass or black patina.

As we are treating artisanal processes, the small pores or irregularities on the surface are natural to the material (brass), adding value to the piece and are never considered to be defects.

Estructura de madera maciza. Zócalo de madera forrado con pletina de latón pulido y barnizado. Tapicería y botonadura en seda natural 100% color violeta de Parma o satén color negro. Brazo en fundición de latón pulido y barnizado o en pátina negra.

Al tratarse de un proceso artesano, los pequeños poros e irregularidades en la superficie del propio material (latón) es un valor añadido, nunca un defecto.

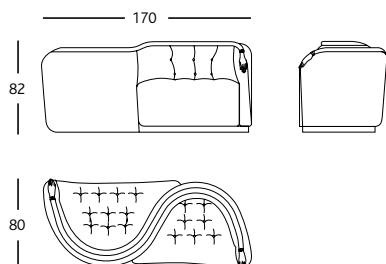

DA0061	Original	30.950
DA0061BL	Black Label (Limited Edition / Edición limitada)	34.598

### PACKAGING

PCS	DIMENSIONS CM	GROSS KG
1	190 x 100 x 100	130

## LEDA SCULPTURE-LOW TABLE / ESCULTURA -MESA BAJA

Salvador Dalí

Design inspired on an artwork by Salvador Dalí: 'Femme à tête de roses' (1935). Structure in polished varnished cast brass or black patina not varnished (Black Label).

As we are treating artesanal processes, the small pores or irregularities on the surface are natural to the material (brass), adding value to the piece and are never considered to be defects.

*Diseño inspirado en una obra de de Salvador Dalí: 'Femme à tête de roses' (1935). Estructura en fundición de latón pulido. Acabado barnizado o pátina negra sin barnizar (Black label).*

*Al tratarse de un proceso artesano, los pequeños poros e irregularidades en la superficie del propio material (latón) es un valor añadido, nunca un defecto.*

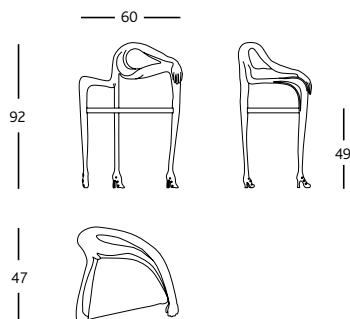

DA0059	<b>Original</b>	23.780
DA0059BL	<b>Black Label</b> (Limited edition of 105 units <i>Edición limitada de 105 unidades</i> )	28.210

### PACKAGING

PCS	DIMENSIONS CM	GROSS KG
1	100 x 58 x 70	70

## LEDA SCULPTURE-LOW TABLE / ESCULTURA -MESA BAJA

Salvador Dalí

Design inspired on an artwork by Salvador Dalí: 'Femme à tête de roses' (1935). Legs in cast varnished brass or black patina not varnished (Black Label). Table top in brushed and varnished brass or black patina (Black Label). Carrara marble egg on top or Nero Marquina marble egg (Black Label).

As we are treating artesanal processes, the small pores or irregularities on the surface are natural to the material (brass), adding value to the piece and are never considered to be defects.

*Diseño inspirado en una obra de de Salvador Dalí: 'Femme à tête de roses' (1935). Pie en fundición de latón pulido. Acabado barnizado o pátina negra sin barnizar (Black label). Sobre en latón matizado y barnizado o pátina negra (Black label). Huevo en mármol de Carrara o Nero Marquina (Black Label).*

*Al tratarse de un proceso artesano, los pequeños poros e irregularidades en la superficie del propio material (latón) es un valor añadido, nunca un defecto.*

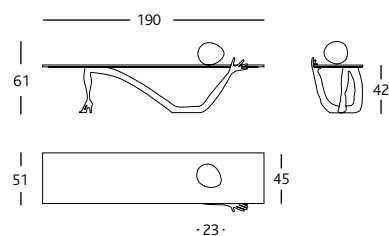

DA0060	<b>Original</b>	19.236
DA0060BL	<b>Black Label</b> (Limited edition of 105 units <i>Edición limitada de 105 unidades</i> )	22.862

### PACKAGING

PCS	DIMENSIONS CM	GROSS KG
1	200 x 70 x 55	55



## BRACELLI, MULETAS &amp; CAJONES LAMPS / LÁMPARAS

Salvador Dalí

The Bracelli lamp has a wooden board structure covered in fine gilding also available in a darker version. The lampshade is covered in an ivory coloured cotton and rayon fabric. The Muletas and Cajones lampstands are made of bleached lime-wood, varnished or black stained and varnished. Lampshade covered in a beige coloured lingerie satin or lined in the same material and covered in a black transparent chiffon.

*Bracelli: estructura de tablero recubierto con láminas de latón doradas mediante técnica de pan de oro, o versión pan de oro oscurecido. Pantalla de tejido de algodón y rayón color marfil. Muletas y Cajones: estructura de talla de tilo decolorada y barnizada o teñida en negro y barnizada. Pantalla de raso de lencería color beige o interior raso de lencería color beige y exterior gasa de lencería color negro.*

## Bracelli

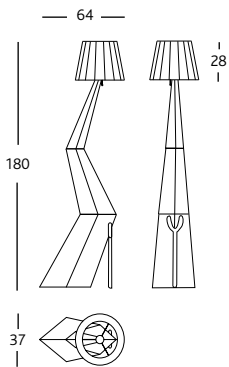

## Muletas

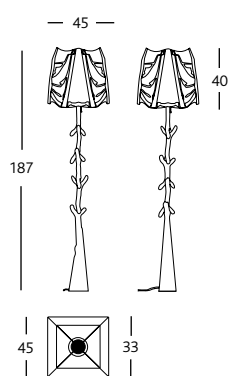

## Cajones

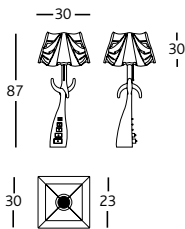

DA0064	<b>Bracelli</b>	6.025
DA0064BL	<b>Bracelli Black Label*</b>	7.230
DA0065	<b>Muletas</b>	3.952
DA0065BL	<b>Muletas Black Label*</b>	4.178
DA0066	<b>Cajones</b>	3.314
DA0066BL	<b>Cajones Black Label*</b>	3.581

- Hand-crafted lampshades
- Spherical bulb Led
- E27 power 9W T 3000K 850 lumen Energy Value A+
- CE UNE-EN 60598-1
- Cortinas hechas a mano.
- Bombilla esférica Led.
- E27 potencia 9W T 3000K 850 lumens Valor Energético A+
- CE UNE-EN 60598-1

\*Limited edition of 105 units  
Edición limitada de 105 unidades

## PACKAGING

	PCS	DIMENSIONS CM	GROSS KG
Bracelli structure / estructura	1	83 x 43 x 190	42
Bracelli shade / pantalla	1	45 x 45 x 40	8
Muletas structure / estructura	1	80 x 28 x 30	28
Muletas shade / pantalla	1	60 x 60 x 60	6
Cajones structure / estructura	1	90 x 26 x 30	12
Cajones shade / pantalla	1	45 x 42 x 38	4

## RINOCERÓNICO KNOB / TIRADOR

Salvador Dalí

Three polished lacquered cast bronze pieces joined together.  
*Tres piezas ensambladas en fundición de bronce pulido y barnizado.*

## Simple

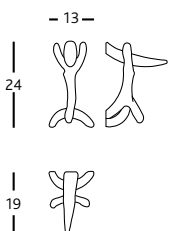

## Double

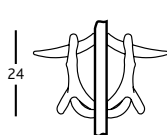

DA0062	<b>Single / Sencillo</b>	2.964
DA0063	<b>Double / Doble</b>	5.836

## PACKAGING

	PCS	DIMENSIONS CM	GROSS KG
	1	35 x 42 x 30	6

XAI

Salvador Dalí

Design inspired on an artwork by Salvador Dalí: 'Interpretation Project for a stable-library' (1942). Limited Edition of 20 unique pieces in white and 1 in black. Stuffed lamb, elaborated with a technique by a taxidermist.

*Diseño inspirado en una obra de Salvador Dalí: 'Proyecto de interpretación para un establo-biblioteca' (1942). Edición limitada de 20 piezas únicas en blanco y 1 en negro. Cordero disecado elaborado con la técnica de la taxidermia.*

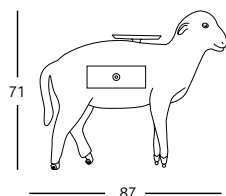

XAI04

42.000

PACKAGING

PCS	DIMENSIONS CM	GROSS KG
1	101 x 92 x 121	30

INVISIBLE PERSONAGE / PERSONAJE INVISIBLE

Salvador Dalí

Design inspired on an artwork by Salvador Dalí: 'Singularities' (1935). Limited Edition of 20 unique pieces. A composite structure upholstered in natural sheepskin with a gloss lacquered polyamide lamp (with a pearl finish and gold colour interior). Light: 500 lumens. Colour temperature: 3000K. Power: 4.8W.

*Diseño inspirado en un cuadro de Salvador Dalí: 'Singularidades' (1935). Edición limitada de 20 piezas únicas. Estructura en composite tapizada en piel natural de oveja. Luminaria en poliamida lacada, exterior color perla e interior color oro perlado mate. La luminosidad es de 500 lumens a temperatura de 3000k y una potencia de 4,8W.*

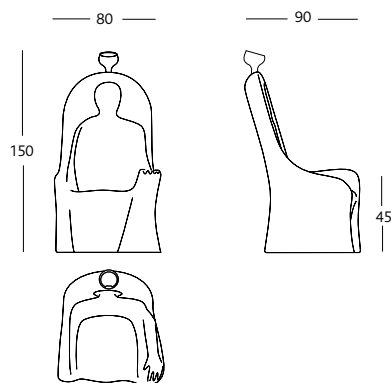

INVPER

50.000

LED lamp included / Incluye lámpara LED

PACKAGING

PCS	DIMENSIONS CM	GROSS KG
1	90 x 100 x 163	55

**XAI AND INVISIBLE PERSONAGE MAINTENANCE AND CLEANING**

It is important that these pieces not be exposed to a relative humidity above 65%. Avoid placing furniture in direct sunlight. These pieces should be cleaned with a cotton cloth at least once a week to take away any dirt from the upholstery. Clean using a vacuum on low to remove any natural dust. A humid cloth, using only water can also be applied to clean this item. For grease marks, please refer this piece onto a leather or a cleaning specialist.

**MANTENIMIENTO Y LIMPIEZA DEL XAI Y PERSONAJE INVISIBLE**

*Es importante que estas piezas no estén expuestas a una humedad relativa superior al 65%. Evite colocar los muebles al sol directo. Estas piezas deben limpiarse con un paño de algodón al menos una vez a la semana para eliminar la suciedad de la tapicería. Utilice una aspiradora a baja potencia para eliminar el polvo. También se puede limpiar con un paño húmedo. Para marcas de grasa, dirjase a un especialista en limpieza de pieles.*



## CRISTALLO CUPBOARD / ARMARIO

Alessandro Mendini

MDF laquered in different colours. Interior veneered in sycamore wood with frontal finishes stained in a darker colour, the same as the base. The exterior faces of the doors are also veneered in sycamore, featuring a printed graphic. All of the wooden exterior sides have a satin finish, and the coloured sections in a glossed finish. Limited edition of 99 units.

Tableros de MDF lacados en diferentes colores. Interior chapado en madera de sicomoro con el frontal teñido de un color oscuro al igual que el zócalo. Las puertas, también chapadas en sicomoro en la parte frontal, presentan una gráfica impresa en la madera. Todas las caras vistas de la madera tienen un acabado satinado mientras que todas las caras coloreadas son brillantes. Edición limitada de 99 unidades.

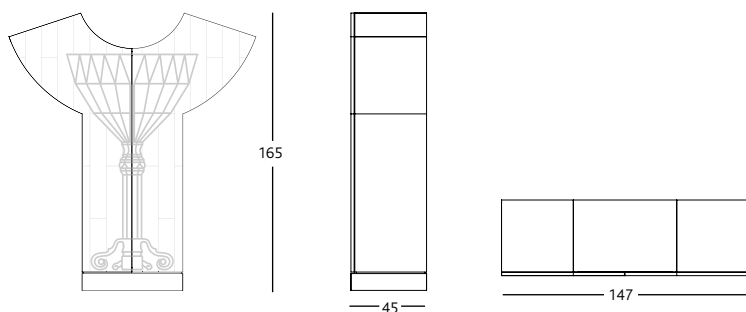

CRISTALLO 20.483

## PACKAGING

PCS	DIMENSIONS CM	GROSS KG
1	160 x 55 x 180	150

## TIGER ART GAULINO EASY CHAIR / SILLONCITO

A limited edition of 50 unique pieces of hand-painted seats with tiger fur patterns by Oscar Tusquets. Ash wood with a coloured patina, dark stained and varnished. A hand painted natural leather seat.

Una serie limitada de 50 ejemplares con asiento pintado a mano con interpretaciones de la piel del tigre por Oscar Tusquets. Madera de fresno con patina de color en el poro, teñido oscuro y barnizado. Asiento en cuero natural pintado a mano

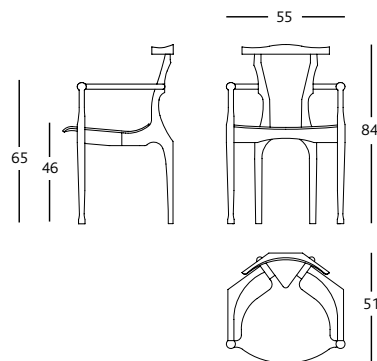

8.000

## PACKAGING

PCS	DIMENSIONS CM	GROSS KG
1	78 x 84 x 83	13

## METTSASS

Ettore Sottsass Jr.

The structure is of flat sheets of steel painted in red. The glass on the top is painted in the same colour as the structure.

Estructura en chapas planas de acero pintadas en rojo. El vidrio en la parte superior está pintado en el mismo color que la estructura.

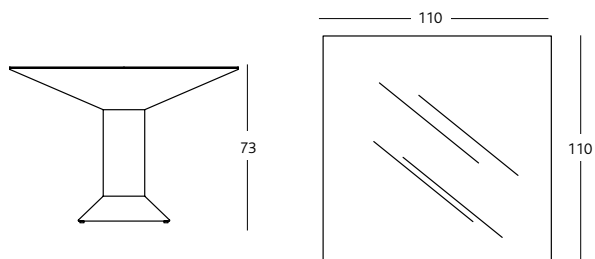

METE07V07 5.429

## PACKAGING

	PCS	DIMENSIONS CM	GROSS KG
glass + bell / vidrio + campana	1	120 x 120 x 40	40
set / conjunto	1	50 x 70 x 80	20

# REMIX COLLECTION

## REMIX VOL.1 CANDLEHOLDERS / CANDELABROS

Curro Claret

Polished varnished brass / Latón pulido barnizado

3 CANDLES / 3 ESCUDOS

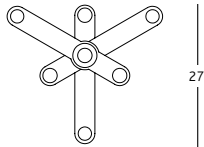
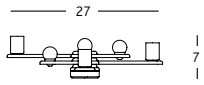

5 CANDLES / 5 ESCUDOS

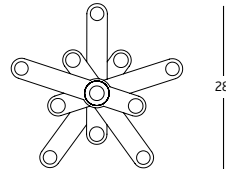
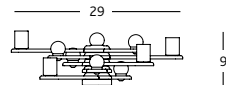

2017 Ecodesign Award / Premio de Ecodiseño 2017

**3 candles / 3 escudos**  
Limited edition of 225 units  
*Edición limitada de 225 unidades*

297

**5 candles / 5 escudos**  
Limited edition of 75 units  
*Edición limitada de 75 unidades*

453

### PACKAGING

	PCS	DIMENSIONS CM	GROSS KG
3 candles / 3 escudos	1	40 x 40 x 15	4
5 candles / 5 escudos	1	40 x 40 x 15	6

## REMIX VOL. 2 CABINET

Ramón Úbeda

Modules, frontals and shelves veneered in natural stained dark oak. Legs in aluminium with a brass coating. Accessories plated in 24 carat gold and polished.  
*Contenedor, frontales y estantes chapados en roble natural teñido oscuro. Patas en aluminio con baño de latón. Accesorios en latón pulido bañado en oro de 24K.*

### HELIX CABINET

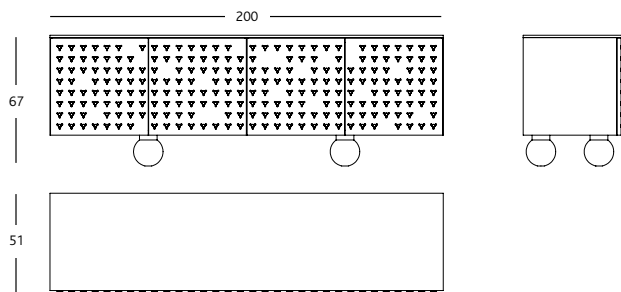

### HELIX CABINET

Limited Edition of 3u / *Edición limitada de 3 un.*

32.000

### SLIDING CABINET

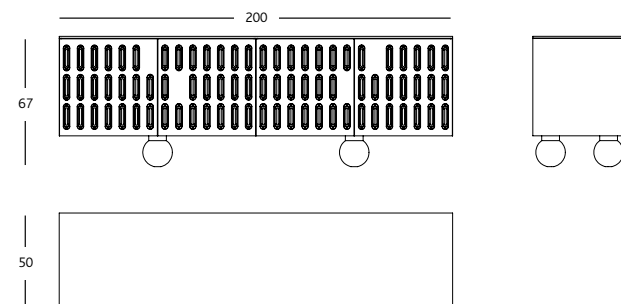

### SLIDING CABINET

Limited Edition of 1u / *Edición limitada de 1 un.*

50.000

### PACKAGING

	PCS	DIMENSIONS CM	GROSS KG
	2	110 x 65 x 90	100
	1	210 x 50 x 70	55



## REMIX VOL. 5

Belén Moneo

## Bookshelves / Estanterías

Finishes: Varnished beech wood columns. Transparent methacrylate shelves. Limited edition of 3 units .

Acabados: columnas en madera de haya barnizadas. Estantes en metacrilato transparente. Edición limitada de 3 unidades.

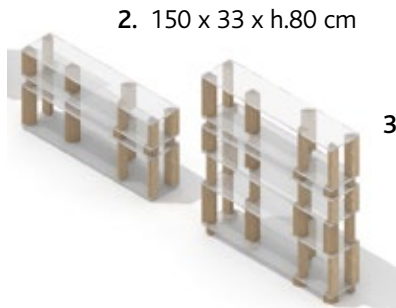

2. 150 x 33 x h.80 cm

3. 150 x 37 x h.150 cm

2. 80 cm Bookshelf Estantería 80 cm	7.000
3. 150 cm Bookshelf Estantería 150 cm	10.500

## REMIX VOL.6

Las Ánimas

Unique pieces.

A black painted fibreboard with inserted magnets. White graphics in white. Geometric objects (three shapes) made of ash wood and an incorporated magnet in the following colours: yellow, cyan, blue, red and green. The final client can customise the geometric pieces to create his/her own composition.

Piezas únicas.

Tablero de aglomerado con imanes insertados y pintado en negro. Gráfica en blanco. Piezas geométricas de madera de fresno con imán, 3 formas en 5 colores: amarillo, cian, azul, rojo, verde. El cliente puede configurar la composición de las piezas geométricas a su gusto.



Shapes / Formas



Cupboard / Armario	25.000
Table / Mesa 180 x 80	11.500
Buc (1 filing drawer + 1 drawer / 1 archivador + 1 cajón)	5.500

Cupboard / Armario

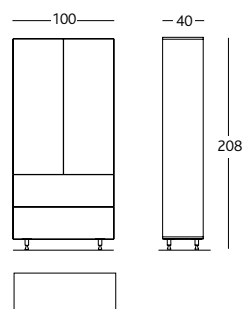
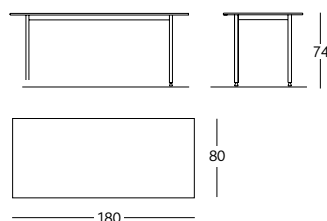
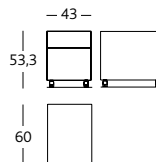

Table / Mesa



Buc



## PACKAGING

	PCS	DIMENSIONS CM	GROSS KG
Cupboard / Armario	1	110 x 57 x 230	100
Mesa / Table	1	190 x 12 x 100	20
Buc	1	53 x 70 x 62	25

## POSTCRAFT COLLECTION

Limited edition 8 pieces + 2 prototypes + 2 A.P. / Edición limitada de 8 piezas + 2 prototipos + 2 pruebas de artista

### WALKING HEN CANDLEHOLDER / CANDELABRO

Aisha Al Sowaidi

Claws in cast brass and hinges in steel - both in a 24 carat gold plated finish. Eggs in concrete.

Garras de fundición de latón y bisagra de acero, ambas con baño de oro de 24K. Huevos de cemento arquitectónico.

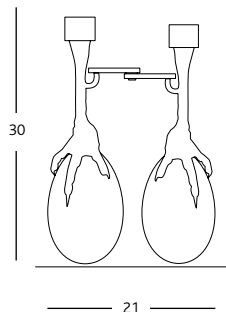

WALKING HEN

8.500

#### PACKAGING

PCS	DIMENSIONS CM	GROSS KG
1	40 x 40 x 15	10

### IS-DHER VASES / JARRONES

H.E. Shk. Hind Majid Al Qassimi

Glazed stoneware in three different finishes: 24 carat gold, platinum and a beige engobe.

Cerámica esmaltada con tres acabados: oro de 24 kilates, platino y engalba de color beige.

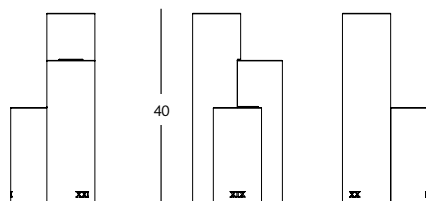

IS-DHER VASES

7.000

#### PACKAGING

PCS	DIMENSIONS CM	GROSSKG
1	50 x 50 x 15	10

### TAOLA SIDE TABLE / MESA AUXILIAR

Gazzaz Brothers

Legs in solid oak. Tray in woven red ribbon and craft paper.

Estructura de roble macizo con degradado de rojo a roble natural. Bandeja tejida con cinta de papel craft y cinta textil de color rojo.

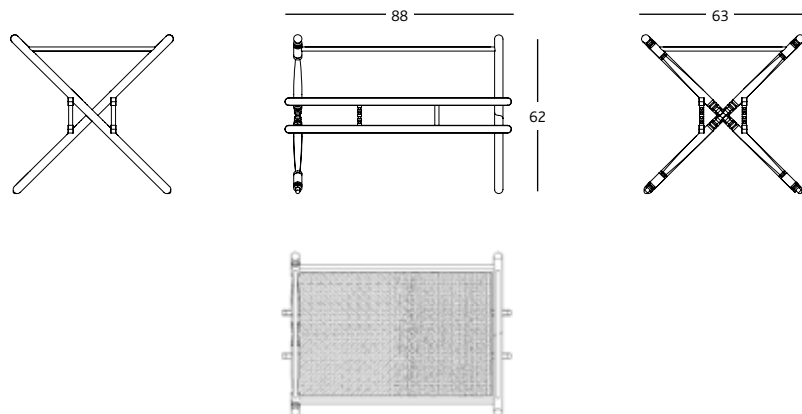

TAOLA SIDE TABLE

9.000

#### PACKAGING

PCS	DIMENSION CM	GROSS KG
1	78 x 75 x 90	40





# POSTCRAFT COLLECTION

Limited edition 8 pieces + 2 prototypes + 2 A.P. / Edición limitada de 8 piezas + 2 prototipos + 2 pruebas de artista

STORAGE AND SHELVING  
ESTANTERÍAS Y CONTENEDORES

TABLES  
MESAS

ARMCHAIRS  
BUTACAS

CHAIRS AND STOOLS  
SILLAS Y TABURETES

ACCESSORIES  
ACCESORIOS

LIGHTING  
ILUMINACIÓN

PUBLIC SEATING  
ASIENTOS PÚBLICOS

ART EDITIONS

## LUNAR TALE MIRROR / ESPEJO

Loulwa Al Radwan

Mirrors in a blue and grey colour. Disc in gold plated aluminium. Box in black lacquered MDF. Movement mechanism in steel.

Espejos de color azul y gris. Disco de aluminio bañado en oro. Caja de MDF lacada en negro. Sistema de movimiento preciso mediante rodamientos, piñones y cremalleras de acero.

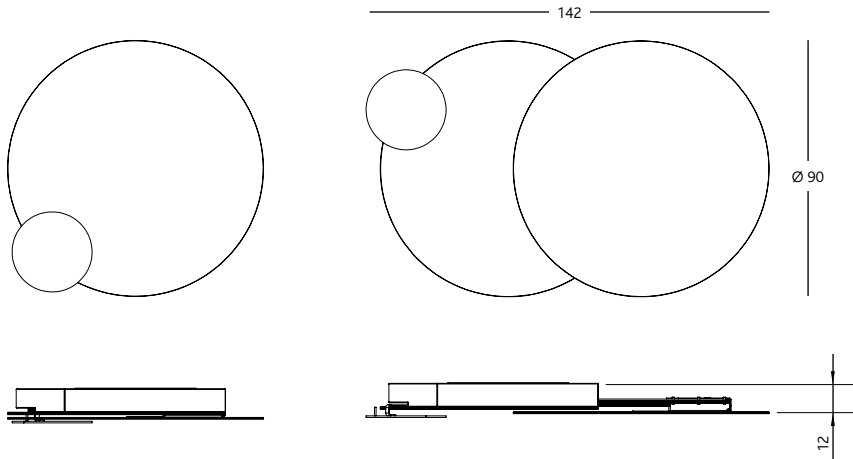

LUNAR TALE 14.000

### PACKAGING

PCS	DIMENSIONS CM	GROSS KG
1	110 x 110 x 30	100

## TALISMAN CABINET

Maysam Al Nasser

A white matte lacquered MDF sideboard with an inscribed inset in solid teak. Interior veneered in teak and incorporates 3 drawers.

Contenedor de MDF lacado exteriormente color blanco mate, con grabado en teca maciza. Interior chapado en teca, incorpora 3 cajones.

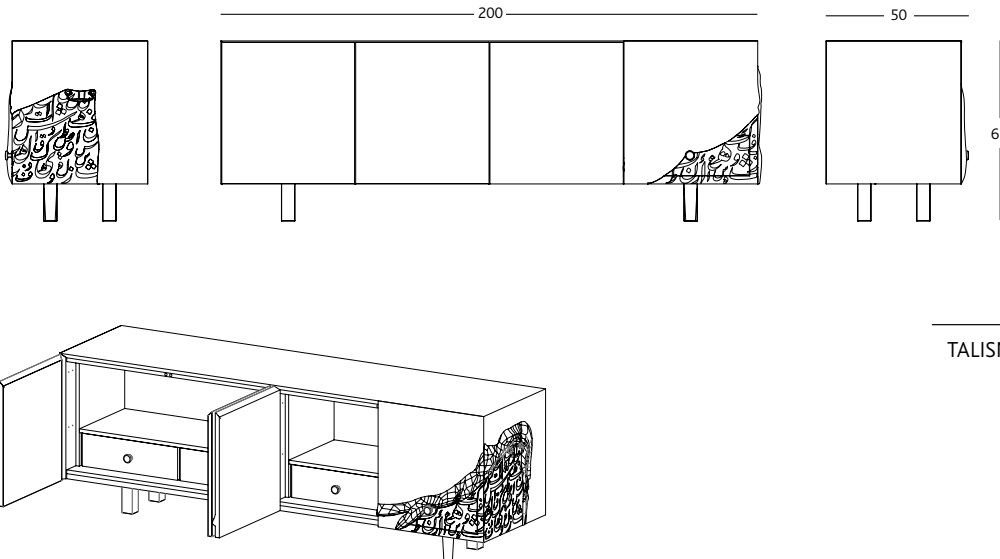

TALISMAN CABINET 24.000

### PACKAGING

PCS	DIMENSIONS CM	GROSS KG
1	220 x 60 x 90	150

## GENERAL CONDITIONS OF SALE (APPLICABLE FOR ALL EXPORT SALES EXCEPT SPAIN)

---

### 1. CATALOGUES AND ORDERS

- 1.1 The information supplied regarding prices, models, dimensions, features and specifications may be modified at any time without prior notice.
- 1.2 The order confirmation is final and binding and must be returned by fax or e-mail duly signed or with the corresponding company stamp.  
If we do not receive any news within 5 days, we consider the order confirmation as accepted.

### 2. CANCELLATION OF ORDERS

- 2.1 Accepted orders may not be cancelled when:
  - After 8 days from the confirmation order.
  - When shipment of the product has already been made.
  - Special materials are used and production has started.

### 3. PRICES

- 3.1 The present price list replaces all previous ones and may be subject to changes without prior notice.
- 3.2 All prices are in Euros excluding VAT. Discounts, payments and delivery conditions will be agreed between BD and customer.
- 3.3 On the invoice of all orders whose delivery address on the BD transport documentation is in Spain (Canary Islands excluded), the Spanish VAT of 21% is mandatory.
- 3.4 If a Certificate of Origin (COO) is required, this must be clearly indicated in writing on confirmation of the order. BD will charge 50€ for the cost of its issuance by the Chamber of Commerce, Industry and Navigation of Barcelona. An additional 50€ will be charged for the invoice to be certified. This will only be provided if requested. If the original copies need to be sent to the addressee/receptor, 50€ will be charged for a courier service.

### 4. DELIVERY

- 4.1 Terms of delivery should be considered indicative. BD Barcelona 1972 S.L. has no responsibility for delays beyond its control.
- 4.2 Once the production of an order is finalized, the client has one month, starting from the moment we inform that the order is ready, to come and collect the goods in our facilities. If this period is exceeded, BD reserves the right to charge storage costs for the amount of 1,50€ per day per m3.

### 5. PAYMENT

- 5.1 All bank charges are the responsibility of the buyer.
- 5.2 All goods not paid in full shall remain property of BD Barcelona 1972 S.L.
- 5.3 Payments not made by their due date as outlined on the client's invoice made by BD Barcelona 1972, S. L. gives BD the right to charge a late payment fixed surcharge of 50 Euros and interest on the total amount. The legal general interest rate applied is the percentage of the Euribor (the interest rate of the European Central Bank of 12 months) with an additional seven percent in accordance with Article 7, Law 3/2004 (29th December) in Prevention of Late Payments related to Commercial Operations. If demonstrated damages are superior to the interest rate applied above, these also will be included in any proceedings made by BD.

### 6. WARRANTY AND POST-SALE SERVICE

- 6.1 Products are guaranteed for two years from date of invoice, provided that they are used under normal circumstances and installed in accordance with prevailing normatives.
- 6.2 During this period BD will only cover the cost related to the repair of the product.
- 6.3 Liability is limited to defects of manufacture. Excluded from this guarantee are all damages made by transport, incorrect use, negligence and normal wear and tear of the merchandise. BD Barcelona 1972 S.L. is explicitly excluded from all responsibility for any damage or loss which such defects may cause, either directly or indirectly.
- 6.4 BD Barcelona 1972 S.L. is not liable under any circumstances for defects that may be present in merchandise when exported by the buyer.

### 7. CLAIMS

- 7.1 If transport is covered by BD, any damage incurred on packaging and products must be indicated on the transporters delivery note immediately on receipt at the delivery address indicated on the transport documents and BD invoice and must notify BD Barcelona 1972 S.L. within 24 hours of reception at the aforementioned delivery address. Failing to do this, BD Barcelona 1972 S.L. will not accept any further claim.
- 7.2 In addition to our product guarantee, BD Barcelona 1972 S.L. shall attend any written claims concerning errors in quantity or defects and any incidents regarding supply, within six days of the receipt of the goods.

### 8. RETURN OF THE GOODS

- 8.1 The return of the goods shall not be accepted without our express written authorisation.

### 9. VENUE, JURISDICTION AND APPLICABLE LAW

In any dispute arising out of or in any way related to this agreement, including any claim sounding in tort or contract (including, but not limited to any claim for negligence and/or products liability), parties agree that the Barcelona Courts shall have exclusive jurisdiction to hear the dispute; and parties agree that they shall not bring a claim in any other jurisdiction.

Parties further agree that any such dispute shall be exclusively governed by the laws of Barcelona, Cataluña and Spain, as applicable, without regard to any conflicts of law or choice of law principles thereof.



# CONDICIONES GENERALES DE VENTA (APLICABLES SÓLO A VENTAS REALIZADAS EN ESPAÑA )

## 1. GENERALIDADES

- 1.1 Todas las relaciones comerciales entre BD Barcelona 1972 S.L., domiciliada en C/ Ramón Turró 126, 08005 Barcelona, con NIF B61713756, (en adelante, el Vendedor) y sus Compradores se regirán por las presentes Condiciones Generales de Venta, excepto en todo aquello que esté expresamente acordado de forma distinta en la oferta correspondiente o en la aceptación del pedido y que constituyan las condiciones particulares del mismo.
- 1.2 Estas Condiciones Generales de Venta, así como aquellas particulares expresadas en el punto 1.1. cuando correspondan, se consideran aceptadas por el Comprador por el mero hecho de cursar un pedido.
- 1.3 El Vendedor se reserva el derecho de actualizar y/o modificar el contenido de las presentes Condiciones Generales de Venta en cualquier momento sin previo aviso, sin perjuicio de los contratos ya perfeccionados.

## 2. CATÁLOGOS

- 2.1 Todas las informaciones y descripciones contenidas en nuestros catálogos y demás documentación son puramente orientativas y no vinculantes.
- 2.2 El Vendedor se reserva el derecho a modificar sin previo aviso la información referente a precios, modelos, dimensiones, características y especificaciones contenida en catálogos y demás documentación, sin perjuicio de lo establecido en el punto 1.

## 3. PEDIDOS

- 3.1 Para que se considere efectivo y vinculante, el pedido tiene que recibir una aceptación expresa por parte del Vendedor. El comprador deberá devolver por fax firmada y sellada o por correo electrónico la confirmación de pedido. De no recibir noticias en un plazo de 5 días hábiles, se considera aceptado y vinculante.
- 3.2 Los pedidos aceptados no podrán ser anulados por parte del Comprador en los casos siguientes:
  - a) Transcurridos 5 días desde la confirmación del pedido por parte del Vendedor.
  - b) Cuando se ha efectuado la expedición del producto y así se ha comunicado al Comprador.
  - c) Cuando, tratándose de materiales de producción especial, ésta se hubiera comenzado y se hubiera comunicado al Comprador el inicio de la producción.

## 4. PRECIOS

- 4.1 Los precios de venta se rigen por la tarifa vigente en cada momento y podrán ser modificados por el Vendedor sin previo aviso, a no ser que ya hayan sido confirmados al Comprador.
- 4.2 Todos los precios son en EUROS y no incluyen el I.V.A. vigente ni cualquier otro impuesto, derecho o tasa, que se repercutirán posteriormente en la factura con los tipos correspondientes. Los descuentos, forma de pago y las condiciones de entrega serán acordados entre el Vendedor y el Comprador en cada caso individualmente.
- 4.3 Para entregas en España, los portes serán pagados para pedidos superiores a los 300€/netos. Para entregas en Andorra, el pedido mínimo será de 250€/netos más 60€ de portes, y a partir de 1000€/netos será libre de portes.
- 4.4 En caso de ser necesaria la emisión de un certificado de origen, el cliente debe indicarlo en el momento de cursar el pedido. BD facturará 50€ para cubrir el coste de su emisión por la Cámara de Comercio, Industria y Navegación de Barcelona, y 50€ adicionales en caso de tener que enviar el original por mensajería. Se cobrarán 50€ adicionales por la certificación de la factura. Esto solo se proporcionará si se solicita.

## 5. CONDICIONES DE PAGO

- 5.1 El pago de las mercancías debe realizarse al contado mediante transferencia bancaria, cheque, recibo domiciliado, salvo que se conceda crédito al Comprador, en cuyo caso se hará efectivo mediante los medios acordados en el plazo o plazos estipulados expresamente.
- 5.2 Para los pedidos de fabricación especial, el Comprador deberá efectuar un pago a cuenta a determinar en cada caso del precio total estipulado, no comenzándose la producción del pedido hasta el abono de la cuantía correspondiente
- 5.3 En todo caso, la demora de pago por facturas vencidas faculta al Vendedor a exigir el pago inmediato de todas las facturas no vencidas, así como el pago anticipado de todas las entregas no efectuadas hasta la fecha y correspondientes a pedidos confirmados. De igual forma, produce la cancelación automática del crédito, en caso de haberse concedido.
- 5.4 En caso de que exista un retraso en la realización del pago, el Vendedor tendrá derecho a exigir intereses de demora por cuantía del interés legal aplicable en cada momento por el Banco Central Europeo incrementado en 8 puntos. Además, el comprador soportará los gastos derivados de los retrasos en el pago de las cantidades acordados (honorarios de abogados, costas judiciales), siendo un mínimo de 50,00€ por caso, todo ello sin perjuicio de demostrar y reclamar un daño superior.
- 5.5 Las facturas han de ser satisfechas por el importe íntegro que se menciona en ella, no haciéndose el Vendedor responsable de los gastos bancarios que al Comprador puedan ocasionarle en función del método de pago seleccionado.

## 6. FORMA DE ENTREGA

- 6.1 La forma de entrega será indicada en caso en las condiciones particulares de cada pedido. Las mercancías vendidas se entienden a disposición del Comprador en los almacenes del Vendedor, cesando la responsabilidad del Vendedor sobre ellas desde el momento en que éste las pone a disposición del transportista (suministro EXW según INCOTERM 2010) a no ser que se haya estipulado otra forma de entrega.
- 6.2 El Vendedor no asume los riesgos del transporte, que serán totalmente a cargo del Comprador, incluso los daños y menoscabos producidos durante el transporte de mercancías, sin perjuicio de que el Vendedor pueda bonificar algún importe, lo cual no supondrá, en todo caso, la derogación de la cláusula anterior ni la aceptación por parte del Vendedor de los riesgos del mismo.
- 6.3 Los plazos de entrega de la mercancía deben considerarse indicativos. El Vendedor no asume responsabilidad alguna en caso de demoras, que no autorizan al Comprador a la anulación del pedido ni a la aplicación de penalizaciones o indemnizaciones, salvo que se haya convenido expresamente lo contrario por escrito. Aún en este caso, si fuera por causas de fuerza mayor y BD no pudiera cumplir algún compromiso acordado, no sería aplicable sanción alguna.
- 6.4 Una vez terminada la producción del pedido, el cliente dispone de 1 mes para recoger la mercancía en nuestras instalaciones a contar desde nuestra comunicación de que el pedido está preparado. En caso de superar este plazo de tiempo, BD se reserva el derecho de cargar como gastos de almacenamiento el importe de 1,5€ al día por m<sup>3</sup>.

## 7. FUERZA MAYOR

- 7.1 En caso de que el Vendedor se vea impedido, total o parcialmente, para el cumplimiento de sus obligaciones contractuales por causa de fuerza mayor, el cumplimiento de la/s obligación/es afectada/s quedará suspendido, sin responsabilidad alguna del Vendedor, por el tiempo que sea razonablemente necesario según las circunstancias.

El Vendedor tendrá en casos de fuerza mayor derecho a retrasar la entrega de la mercancía y, en caso de que persistan durante más de un mes, a anular los pedidos, sin obligación de indemnización al Comprador. Aún en el caso de que las partes hubieran acordado expresamente penalizaciones e indemnizaciones por demoras en la entrega de la mercancía, ésta no corresponderá en casos de que la demora sea debida a causas por fuerza mayor.

## 8. GARANTÍA Y SERVICIO POSTVENTA

- 8.1 Los productos del Vendedor tienen una garantía de dos años a partir de la fecha de emisión de la factura por el Vendedor.
- 8.2 Durante este plazo, el Vendedor cubrirá únicamente los defectos de fabricación, los gastos de envío, así como los costes internos de mano de obra y los materiales.
- 8.3 Se excluyen los daños originados por el transporte, uso indebido, negligencias, desgaste natural de la mercancía y los materiales suministrados por el Comprador. En ningún caso el Vendedor responderá por los daños y perjuicios que por el defecto en el producto hayan podido producirse, directa o indirectamente.
- 8.4 El Vendedor no se responsabiliza de una conservación incorrecta de los materiales plásticos frente a la repulsión al polvo y los acondicionamientos climáticos.
- 8.5 El vendedor no se responsabiliza en ningún caso de los defectos que pueda presentar la mercancía en el caso de que ésta haya sido exportada por el comprador.

## 9. RECLAMACIONES

- 9.1 Cualquier incidencia sufrida por los productos durante su transporte, deberá hacerse constar expresamente y con claridad suficiente en el albarán de entrega del transportista, debiendo ser comunicada esta incidencia al Vendedor antes de transcurridas 24 horas desde su recepción. En caso contrario, el Vendedor no responderá por reclamaciones del Comprador, a salvo de lo establecido en el artículo 8.1 de estas Condiciones Generales de Venta.
- 9.2 Además de la garantía recogida en el artículo 8.1 de estas Condiciones Generales de Venta, el Vendedor atenderá a reclamaciones basadas en errores o defectos en la cantidad suministrada de los productos o cualquier disconformidad en relación al suministro de los mismos, siempre que estas reclamaciones sean comunicadas al Vendedor por escrito dentro de los 6 días siguientes a la recepción de la mercancía. Cumplido ese plazo, se presume que la mercancía suministrada es conforme con el pedido realizado y no se admitirá reclamación alguna posterior.
- 9.3 Las posibles reclamaciones de cualquier tipo no dan derecho a suspender los pagos acordados (si las reclamaciones tienen origen en un incumplimiento de BD, el comprador debería poder rescindir el contrato y por lo tanto, suspender los pagos acordados).

## 10. DEVOLUCIONES

No se aceptarán devoluciones de las mercancías, salvo que el Vendedor expresamente las autorice por escrito.

## 11. PROPIEDAD DE LA MERCANCÍA

- 11.1 El Vendedor se reserva el derecho a la plena propiedad de los bienes vendidos hasta el pago total y efectivo por el Comprador del precio e importes facturados. El Comprador podrá transformar o revender dichos bienes en el marco de una normal gestión comercial, no transfiriéndose, en el marco de esta reserva de dominio, la propiedad de las mismas al Comprador ni, en su caso, al comprador de la reventa. En este sentido, el Comprador está obligado a informar al Vendedor sobre todas las medidas

adoptadas por terceros que afecten a los bienes mientras sean propiedad del Vendedor.

## 12. PROTECCIÓN DE DATOS

- 12.1 Los datos personales facilitados por el Comprador serán incorporados a un fichero titularidad del Vendedor e inscrito en la Agencia de Protección de Datos, con la finalidad de tramitar y facturar los pedidos, resolver las posibles incidencias que se produzcan así como para facilitar al Comprador la recepción de información y/o correspondencia que pudiera ser de su interés.
- 12.2 Los datos del Comprador serán tratados exclusivamente por el Vendedor, quien decidirá sobre el contenido, la finalidad y el uso que se dé a las mismas.
- 12.3 En cumplimiento de lo dispuesto en la Ley Orgánica 15/1999, de 13 de diciembre, el Comprador podrá ejercer sus derechos de acceso, rectificación, cancelación y oposición dirigiéndose por escrito a BD Barcelona 1972, S.L., con domicilio en la C/ Ramón Turró 126, 08005 Barcelona.
- 12.4 En cualquier caso, se informa al Comprador que, cuando los datos estén asociados a una compra, deberán mantenerse durante el período que legal y fiscalmente indique la legislación española, pudiéndose bloquear, pero no borrar ni rectificar.

## 13. JURISDICCIÓN

- 13.1 Las partes acuerdan mutuamente que todo litigio, independiente de su naturaleza, relativo a la presente venta, su cumplimiento, ejecución e interpretación, incluyendo también reclamaciones de agravio o contrato (incluyendo pero no limitado a cualquier reclamación de negligencia y/o responsabilidad del producto), será sometida a la competencia exclusiva de los Juzgados y Tribunales de la ciudad de Barcelona (España), con expresa renuncia de las partes de reclamar en otra jurisdicción. Además, las partes acuerdan que a cualquier disputa serán de aplicación exclusivamente las disposiciones legales y reglamentarias aplicables a la ciudad de Barcelona, Cataluña y España, sin perjuicio de conflictos de leyes o principios de derecho resultantes.



BD Barcelona Design

Ramon Turró, 126  
08005 Barcelona, Spain  
+34 93 457 00 52  
sales@bdbarcelona.com  
comercial@bdbarcelona.com

www.bdbarcelona.com



Product specifications are for general information only. BD reserves the right to change design and finish without prior notice.

*Las especificaciones que se facilitan son a título orientativo. BD se reserva el derecho de modificar sin previo aviso los diseños y acabados.*

A large, thick white circle is centered on the page, containing the text 'barcelona design' in a white, lowercase, sans-serif font.

barcelona  
design